

2010/2011

Product Catalogue



Produktkatalog
Catalogue Produits
Catalogo Prodotti

KNORR-BREMSE



Product Catalogue

2010/2011

- Pneumatic and Electronic Systems for Commercial Vehicles
- System Specific Workshop Equipment

Produkt Katalog

2010/2011

- Pneumatische und elektronische Systeme für Nutzfahrzeuge
- Systemspezifische Werkstattausrüstung

Catalogue Produits

2010/2011

- Systèmes Pneumatique et Electronique pour Véhicules Utilitaires
- Equipements Atelier pour Systèmes Spécifiques

Catalogo Prodotti

2010/2011

- Sistemi Pneumatici ed Elettronici per Veicoli Commerciali
- Equipaggiamenti di Riparazione specifici per l'Officina

The information contained in this document is intended for the exclusive use of trained persons within the commercial vehicle industry, and must not be passed on to any third party.

All recommendations regarding products and their servicing or usage are with reference to Knorr-Bremse products and should not be considered applicable to products from other manufacturers.

This information does not purport to be all-inclusive and no responsibility is assumed as a result of its use. We cannot accept any liability nor offer any guarantee regarding data accuracy, completeness or timeliness. The information does not represent any guarantee or ensured characteristics of the Products or Systems described.

No liability can be accepted based on the information, its use, recommendations or advice provided. In no event may we be held liable for any damage or loss except in the case of wilful intent or gross negligence on our part, or if any mandatory legal provisions apply.

Any legal disputes arising from the use of this information shall be subject to German law.

Note: If service work is carried out on a vehicle as a result of information taken from this document, it is the responsibility of the workshop to ensure the vehicle is fully tested and in full functional order before the vehicle is returned into service. Knorr-Bremse accepts no liability for problems caused as a result of appropriate tests not being carried out.

This disclaimer is an English translation of a German text, which should be referred to for all legal purposes.

Die Informationen in diesem Dokument sind ausschließlich für die Nutzung durch qualifizierte Personen aus der Nutzfahrzeugindustrie bestimmt und dürfen nicht an Dritte weitergegeben werden.

Alle Empfehlungen in Bezug auf Produkte und ihre Wartung oder Nutzung beziehen sich auf Produkte von Knorr-Bremse und gelten nicht für Produkte anderer Hersteller.

Diese Informationen decken nicht alle denkbaren Bereiche ab, und es wird keinerlei Verantwortung infolge der Nutzung übernommen. In Bezug auf die Richtigkeit, Vollständigkeit oder Aktualität der Daten wird keine Haftung übernommen. Insbesondere stellen die gemachten Angaben keine Garantien oder zugesicherte Eigenschaften in Verbindung mit den beschriebenen Produkten oder Systemen dar.

Auf der Grundlage der Informationen, ihrer Nutzung, der bereitgestellten Empfehlungen oder Ratschläge kann keine Haftung übernommen werden. Eine Haftung für Schäden oder Verluste ist generell ausgeschlossen, soweit nicht Vorsatz oder grobe Fahrlässigkeit von uns zu vertreten ist bzw. zwingende gesetzliche Vorschriften entgegenstehen.

Für juristische Auseinandersetzungen, die aus der Nutzung dieser Informationen entstehen, ist das materielle deutsche Recht maßgebend.

Anmerkung: Sofern infolge der Informationen aus diesem Dokument an einem Fahrzeug Servicearbeiten durchgeführt werden, muss durch die Werkstatt sichergestellt werden, dass das Fahrzeug umfassend getestet wird und in einen voll funktionsfähigen Zustand versetzt wird, bevor das Fahrzeug wieder zum Einsatz kommt. Knorr-Bremse übernimmt keine Haftung für Probleme, die darauf zurückzuführen sind, dass diesbezügliche Tests und die erforderlichen Maßnahmen nicht durchgeführt wurden.

Les informations contenues dans le présent document sont exclusivement destinées à une utilisation par des personnes qualifiées appartenant à l'industrie des véhicules commerciaux ; elles ne doivent pas être transmises à des tiers.

Toutes les recommandations concernant les produits et leur entretien ou utilisation se réfèrent aux produits Knorr-Bremse et ne s'appliquent pas aux produits provenant d'autres fabricants.

Lesdites informations ne couvrent pas tous les domaines et nous n'assumons aucune responsabilité pour l'utilisation de ces informations. Nous n'assumons aucune responsabilité et n'offrons aucune garantie en ce qui concerne l'exactitude, l'exhaustivité ou l'actualité des données. Les informations ne constituent aucune garantie ou assurance des caractéristiques des produits ou systèmes qui y sont décrits.

Aucune responsabilité ne sera assumée sur la base de ces informations, de leur utilisation, ainsi que des recommandations ou conseils fournis. Nous ne pourrions en aucun cas être tenus responsables pour les dommages ou pertes, excepté en cas d'intention ou de négligence grossière de notre part, ou en cas d'application de dispositions légales impératives.

Tout litige résultant de l'utilisation de ces informations sera soumis à la loi matérielle allemande.

Note: si des travaux de maintenance sont effectués sur un véhicule sur la base d'informations tirées du présent document, il est de la responsabilité de l'atelier de veiller à ce que le véhicule soit parfaitement testé et en parfait état de fonctionnement avant qu'il ne soit remis en service. Knorr-Bremse n'assume aucune responsabilité pour tout problème résultant de la non-réalisation de tests appropriés.

Ce disclaimer / cette exclusion de responsabilité est la traduction en français d'un texte allemand qui fera foi dans tous les buts légaux.

Le informazioni contenute in questo documento sono destinate esclusivamente all'utilizzo da parte di personale qualificato operante all'interno dell'industria dei veicoli commerciali e non possono essere trasmesse a terzi.

Tutte le raccomandazioni che interessano i prodotti, il loro utilizzo e manutenzione sono espressamente riferite a prodotti Knorr-Bremse e non valgono in riferimento a prodotti di altri costruttori.

Tali informazioni non sono esaustive e non ci si assume nessuna responsabilità per il loro uso. Non possiamo assumerci inoltre nessuna responsabilità, né prestare garanzie di qualsiasi tipo, in merito alla correttezza, alla completezza o all'attualità delle informazioni riportate. Tali informazioni non equivalgono in alcun modo ad una garanzia di caratteristiche di un prodotto o sistema.

Non può essere accettata alcuna responsabilità in base alle informazioni, al loro uso, alle raccomandazioni o a consigli. È generalmente esclusa ogni garanzia per danni o perdite, tranne che nei casi di dolo o colpa grave a noi imputabile, ovvero laddove ciò sia prescritto da norme imperative di legge.

Ogni eventuale controversia giuridica derivante dall'uso delle presenti informazioni è disciplinata dalle norme del diritto tedesco.

Nota: In caso sulla base delle informazioni contenute in questo documento siano eseguite opere di manutenzione su un veicolo, rientra nella responsabilità dell'officina eseguire una completa verifica del veicolo e del suo perfetto funzionamento prima del suo impiego. Knorr-Bremse non si assume nessuna responsabilità per problemi insorti a seguito della mancata esecuzione di verifiche appropriate.

Il testo del presente Disclaimer / Clausola di esclusione della responsabilità è la traduzione italiana dell'originale tedesco che mantiene esclusiva validità ad ogni fine di legge.

	Page
Introduction	6
Einleitung	6
Introduction	7
Introduzione	7
Index – Product Families	8
Verzeichnis – Produktfamilien	8
Index – Familles de Produits	9
Indice – Famiglie Prodotto	9
Technical Product Information	10
Technische Produktinformationen	10
Informations techniques de produits	10
Informazioni tecniche prodotto	10
Index – Products in Part Number order	234
Verzeichnis – Produkte nach Teilenummern geordnet	234
Index – Produits Classification par Numéro	234
Indice – Prodotti Ordinati per Codice	234
Index – Products in Type Number order	299
Verzeichnis – Produkte nach Typnummern geordnet	299
Index – Produits Classification par Type	299
Indice – Prodotti Ordinati per Catalogo	299

This catalogue is designed to provide an overview of the range of products for braking and suspension systems that have been supplied by Knorr-Bremse Systems for Commercial Vehicles for fitment to a wide range of vehicles in recent years.

Products have been included in 'system' order by Product Family – i.e. from compressor through to wheel end and, within each section, products are listed in Type Number order where applicable, otherwise by Part Number. Several indexes allow searching by product description, by Part Number and by Type Number. In general, Part Numbers listed in the Product Family tables should be available from your local Knorr-Bremse Distributor. However, due to the ever-changing range and population of products in the market, in some cases Part Numbers listed in previous catalogues may no longer be available. If you are unable to find the Part Number you are looking for in the Product Family sections, the index will show if it has been superseded. If you are still unable to find the Part Number, you should go to:

www.Knorr-BremseCVS.com

or call your local Knorr-Bremse representative.

Whilst every effort has been made to ensure the accuracy of the data in this catalogue, we reserve the right to amend or change this information without notice. Should you find any errors or omissions, or have any comment regarding catalogue layout, please send an email with the details to:

webmaster.truck@Knorr-Bremse.com or call your local Knorr-Bremse representative.

Dieser Katalog wurde erstellt, um Ihnen einen Überblick über die in den letzten Jahren durch die Knorr-Bremse angebotenen Produkte von Nutzfahrzeuggremis- und Luftfederungssystemen zum Einbau in eine Vielzahl verschiedener Fahrzeuge zu geben.

Der Katalog ist in Produktfamilien gegliedert. Die Reihenfolge der Kapitel orientiert sich am Bremssystemaufbau, d.h. beginnend vom Kompressor über die Steuerkomponenten bis zur Bremse am Rad. Innerhalb jedes Kapitels sind die Produkte in Tabellen, und soweit vorhanden nach Typnummern sortiert, andernfalls nach Sachnummern. Verschiedene Inhaltsverzeichnisse und Indexe ermöglichen eine Suche nach Produktbeschreibung, Teile- oder Typnummer. Grundsätzlich sollten die in den Tabellen der Produktfamilien enthaltenen Artikel durch Ihre lokale Knorr-Bremse Vertretung lieferbar sein. Durch anhaltende Veränderungen des Produktspektrums, und sich ändernde Bedarfe im Markt sind manche Produkte evtl. nicht mehr aufgeführt, bzw. verfügbar. Falls Sie eine Teilenummer im entsprechenden Kapitel des Katalogs nicht finden können, sehen Sie bitte im Index nach, ob das Teil möglicherweise durch eine andere Teilenummer ersetzt wurde. Sollten Sie dennoch keine passende Teilenummer finden, wenden Sie sich bitte an:

www.Knorr-BremseCVS.com oder rufen Sie Ihre lokale Knorr-Bremse Vertretung an.

Obwohl wir uns sehr bemühen, einen fehlerfreien Katalog bereitzustellen, behalten wir uns das Recht zur Verbesserung oder Änderung von Inhalten ohne spezielle Ankündigung derselben vor. Sollten Sie Fehler oder Lücken feststellen oder Anmerkungen zum Aufbau des Kataloges haben, senden Sie bitte eine E-Mail an:

webmaster.truck@Knorr-Bremse.com oder wenden Sie sich an Ihren lokalen Vertreter.

Ce catalogue a été conçu pour permettre d'avoir un aperçu de la gamme des produits relatifs aux systèmes de freinage et de suspension disponibles chez Knorr-Bremse, ces produits étant destinés au montage sur une gamme très étendue de véhicules utilitaires récents.

Les produits sont rentrés en commande 'système' ou par Famille de Produit – allant du compresseur jusqu'aux roueset, dans chaque section, les produits sont listés dans l'ordre par N° de type lorsque cela est applicable, sinon par N° de référence. Certains index permettent d'orienter la recherche par le descriptif Produit, la Référence et le N° de Type. En général, les références mentionnées dans les tableaux de Famille Produit sont disponibles auprès de votre Distributeur Knorr-Bremse. Toutefois, compte tenu de l'évolution permanente de la gamme et du nombre de produits sur le marché, certaines Références mentionnées dans des catalogues antérieurs peuvent, dans certains cas, ne plus être disponibles. Si vous n'êtes pas à même de trouver la Référence que vous recherchez dans les sections de Famille Produit, l'index vous indiquera si celle-ci a été remplacée. Si, malgré tout, vous n'êtes toujours pas à même de trouver la Référence souhaitée, allez sur le site:

www.Knorr-BremseCVS.com or ou bien contactez votre agent local Knorr-Bremse.

En dépit du soin apporté à l'élaboration de ce catalogue visant à garantir la précision des informations, nous nous réservons le droit d'y apporter des modifications sans notification préalable. Si vous deviez constater des erreurs ou omissions, ou encore si vous avez des suggestions ou commentaires concernant la mise en page de ce catalogue, nous vous remercions de nous en faire part en adressant un e-mail à:

webmaster.truck@Knorr-Bremse.com ou bien en contactant votre agent local Knorr-Bremse.

Questo catalogo nasce per far conoscere la gamma di sistemi per la frenatura ed il controllo forniti da Knorr-Bremse Sistemi per Autoveicoli Commerciali, per il montaggio su una vasta gamma di veicoli.

I prodotti sono ordinati per "sistema", cioè per Famiglia Prodotto, dal Compressore ai Freni; inoltre all'interno di ogni sezione i prodotti sono elencati per Catalogo dove possibile, oppure per Codice. Numerosi indici permettono una ricerca semplice per Prodotto, Codice e per Catalogo. In generale, gli articoli elencati nelle tabelle di Famiglia Prodotto dovrebbero essere disponibili presso il Concessionario Knorr-Bremse locale. Tuttavia, a causa di sostituzioni e miglioramenti continui dei prodotti, è possibile che alcuni codici presenti in precedenti cataloghi non siano più disponibili. Se non riesci a trovare l'articolo che cerchi nella sezione principale, l'indice potrebbe mostrarti se l'articolo è stato sostituito. Se anche in questo caso fosse impossibile risalire all'articolo, Ti preghiamo di consultare il sito internet:

www.Knorr-BremseCVS.com oppure di contattare la sede Knorr-Bremse a te più vicina.

Anche se abbiamo fatto tutti gli sforzi possibili per assicurare la correttezza dei dati contenuti in questo catalogo, ci riserviamo il diritto di aggiungere o modificare le informazioni senza preavviso. Nel caso di errori, omissioni o per qualsiasi altro commento, per favore inviaci un email:

webmaster.truck@Knorr-Bremse.com o contatta la sede Knorr-Bremse a te più vicina.

Product families	Section	Page	Produktfamilien	Kapitel	Seite
ABS Components - Trailer	27	88	ABS/EBS Kabel	30	114
ABS Components - Truck & Bus	26	79	ABS-Komponenten - Anhänger	27	88
ABS/EBS Cables	30	114	ABS-Komponenten - Lastwagen und Bus	26	79
Air Disc Brakes	36	159	Anhängerbremventile	21	68
Air Dryers	2	18	Anhängersteuerventile	19	64
Air Processing Units	3	23	Arbeitszylinder	47	222
Alcohol Injectors	5	26	Bremskraftregler	15	55
Brake Chambers	31	125	Bremszylinder	31	125
Check Valves (Single and Double)	22	69	Diagnosegeräte, Servicewerkzeug und Prüfanschlüsse	50	229
Clutch Actuation (Actuators, Servos and Cylinders)	45	207	Drosselventile	23	72
Compressors	1	10	Druckbegrenzer	12	42
Condensers	6	27	Druckregler	10	34
Control Valves	24	73	Druckschalter, pneumatisch	39	189
Coupling Heads	20	66	Druckwandler	18	63
Diagnostic and Service Tools	50	229	EAC – Luftaufbereitungen	4	25
Drain Valves	8	31	EBS-Komponenten - Anhänger	29	105
EBS Components - Trailer	29	105	EBS-Komponenten - Lastwagen und Bus	28	95
EBS Components - Truck & Bus	28	95	ELC-Elektronisches Niveauregelsystem	43	201
Electronic Air Control (EAC) Units	4	25	Entwässerungsventile	8	31
Electronic Level Control (ELC) System	43	201	Federspeicherzylinder	33	152
Filters / Desiccant Cartridges	7	28	Frostschutzmittelpumpen	5	26
Foot Brake Valves	13	45	Fussbremventile	13	45
Gear Change Servos and Valves	46	217	Gabelköpfe	34	153
Governor Valves	9	33	Gestängesteller	35	154
Hand Brake Valves	14	51	Getriebeschalthilfen und Getriebeschaltventile	46	217
Levelling Valves and Adjusting Elements	41	193	Governor	9	33
Lift Axle Valves	44	206	Handbremventile	14	51
Load Sensing Valves	15	55	Hebe/Senkventile	42	200
Operating Cylinders	47	222	Kombizylinder	32	137
Park / Shunt Valves	25	76	Kompressoren	1	10
Parking Brake Actuators	33	152	Kondensierer	6	27
Pressure Limiting Valves	12	42	Kupplungsbetätigung (Kupplungssteller, Verstärker und Zylinder)	45	207
Pressure Proportioning Valves	18	63	Kupplungsköpfe	20	66
Pressure Protection Valves / Charging Valves	11	36	Liftachsventile	44	206
Pressure Switches	39	189	Luftaufbereitungen	3	23
Quick Release Valves	17	62	Luftfederventile und Stellelemente	41	193
Raise / Lower Valves	42	200	Luftfilter / Trockenmittelpatronen	7	28
Relay Emergency Valves	21	68	Lufttrockner	2	18
Relay Valves	16	59	Magnetventile	37	185
Safety Valves	40	192	Park-/Rangierventile	25	76
Silencers	38	187	Pneumatische Scheibenbremsen	36	159
Slack Adjusters	35	154	Prüfanschlüsse	49	228
Solenoid Valves	37	185	Reifendrucküberwachungssystem (TPMS)	48	224
Spring Brakes	32	137	Relaisventile	16	59
Test Connectors	49	228	Rückschlag- und Wechselventile	22	69
Throttle Valves	23	72	Schalldämpfer	38	187
Trailer Control Valves	19	64	Schnelllöseventile	17	62
Tyre Pressure Monitoring System (TPMS)	48	224	Sicherheitsventile	40	192
Unloader Valves	10	34	Überströmventile und Mehrkreisschutzventile	11	36
Yoke Assemblies	34	153	Wegeventile	24	73

Familles de Produits	Section	Page	Famiglie Prodotto	Sezione	Pagina
Actionneur d'embrayage (actionneurs, servos et cylindres)	45	207	Anticongelatori	5	26
Câbles ABS/EBS	30	114	Attuazione Frizione (Attuatori, Servofrizioni, Cilindri)	45	207
Capteurs de Pression	39	189	Cavi ABS/EBS	30	114
Chapes	34	153	Cilindri a Membrana	31	125
Clapets Anti-Retour / Valves anti addition	22	69	Cilindri a Molla	33	152
Composants ABS - Camions et Bus	26	79	Cilindri Doppi a Molla	32	137
Composants ABS - Remorque	27	88	Cilindri Operatori	47	222
Composants EBS - Camion et Bus	28	95	Componenti ABS - Motrici e Bus	26	79
Composants EBS - Remorque	29	105	Componenti ABS - Rimorchio	27	88
Compresseurs	1	10	Componenti EBS - Motrice e Bus	28	95
Correcteurs de Freinage	15	55	Componenti EBS - Rimorchio	29	105
Cylindres à ressort	33	152	Compressori	1	10
Cylindres de Frein Combiné	32	137	Correttori di frenata	15	55
Cylindres de Travail	47	222	Diagnosi, Attrezzi di Riparazione e Connettori di prova	50	229
Dessiccateurs d'air	2	18	Distributori a Mano	14	51
Diagnostic et outillage	50	229	Distributori a Pedale	13	45
EAC Unités Electronique de Contrôle de l'Air	4	25	EAC Unità Controllo Aria Elettroniche	4	25
Electrovalves	37	185	Elettrovalvole	37	185
Epurateurs	6	27	Essiccatori Aria	2	18
Filtres / Cartouches	7	28	Filtri / Cartucce Essiccatore	7	28
Freins à Disque Pneumatique	36	159	Forcelle Assemblate	34	153
Leviers Régleurs	35	154	Freni a Disco Pneumatici	36	159
Limiteurs de Pression	12	42	Giunti di Accoppiamento e Semigiunti	20	66
Pompes Antigél	5	26	Interruttori Pneumatici	39	189
Prises de Pression	49	228	Leve di Registro	35	154
Réducteurs de Pression	18	63	Raccordi di Presa d'Aria	49	228
Régulateurs de Pression	10	34	Regolatori di Pressione	10	34
Régulateurs Governor	9	33	Riduttori di Pressione	12	42
Robinets de Commande à Main	14	51	Riduttori di Pressione Proporzionali	18	63
Robinets de Commande à Pied	13	45	Separatore di Condensa	6	27
Silencieux	38	187	Servoautodistributori	21	68
Système de Contrôle Electronique (ELC)	43	201	Servocomando Cambio e Valvole	46	217
Système de Surveillance de la Pression des Pneus	48	224	Silenziatori	38	187
Têtes d'Accouplement	20	66	Sistema di Controllo Livellamento Elettronico (ELC)	43	201
Unités de Traitement d'Air	3	23	Tyre Pressure Monitoring System (TPMS)	48	224
Valves d'Etranglement	23	72	Unità Trattamento Aria	3	23
Valves de Commande de Remorques	19	64	Valvola di non ritorno (singola e doppia)	22	69
Valves de Commande Monte et Baisse	42	200	Valvole a Pressione Controllata (Mono e Multicircuito)	11	36
Valves de Contrôle	24	73	Valvole Comando Container	42	200
Valves de Desserrage	25	76	Valvole Comando Rimorchio	19	64
Valves de Desserrage Rapide	17	62	Valvole di Controllo	24	73
Valves de Nivellement et éléments réglables	41	193	Valvole di Controllo Sollevamento Asse	44	206
Valves de Protection (Simple et Multi Circuit)	11	36	Valvole di Scarico Rapido	17	62
Valves de Purge	8	31	Valvole di Sfrenatura	25	76
Valves de Relevage d'Essieu	44	206	Valvole di Sicurezza	40	192
Valves de Sécurité	40	192	Valvole di Spurgo	8	31
Valves et Servos de Changement Vitesse	46	217	Valvole di Strozzatura	23	72
Valves Relais	16	59	Valvole Governor	9	33
Valves Relais d' Urgence	21	68	Valvole Livellatrici e tiranti	41	193
Vases à Diaphragme	31	125	Valvole Relé	16	59

1

	Page
1.1 Compressors – Single Cylinder	11
1.2 Compressors – Twin Cylinder	14
1.3 Compressors – Cylinder Heads	17
	Seite
1.1 Kompressoren – Einzylinder	11
1.2 Kompressoren – Zweizylinder	14
1.3 Kompressoren – Zylinderköpfe	17
	Page
1.1 Compresseurs – Monocylindres	11
1.2 Compresseurs – Bicylindres	14
1.3 Compresseurs – Culasses	17
	Pagina
1.1 Compressori – Monocilindrici	11
1.2 Compressori – Bicilindrici	14
1.3 Compressori – Teste	17

Compressors – Single Cylinder
Kompressoren – Einzylinder

Compresseurs – Monocylindres
Compressori – Monocilindrici

	Legend	Legende	Légende	Legenda
A2	Delivery	Ausgang	Sortie	Uscita
A4	Unloader	Steuerung	Pilotage régulation	Comando
A9	Water	Kühlmittel	Circuit d'eau	Acqua
B	Volume	Hubvolumen	Volume	Cilindrata
C	Delivery pressure	Betriebsdruck	Pression délivrée	Pressione d'uscita
D	Base mounted	Fußbefestigung	Fixation par embase	Fissaggio a basamento
E	Flange mounted	Flanschbefestigung	Fixation par flasque	Fissaggio a flangia
F	Side mounted	Seitliche Befestigung	Montage latérale	Fissaggio laterale
G	Through drive	Mit Durchtrieb	Avec support de pompe	Con supporto pompa
H	Air cooled	Luftgekühlt	Refroidi par air	Raffreddato ad aria
I	Water cooled	Wassergekühlt	Culasse refroidie par eau	Testa raffreddata ad acqua
J	Water cooled valve plate	Ventilplatte wassergekühlt	Culasse et porte lame refroidis par eau	Testa e piastra raffreddate ad acqua
K	Uses engine oil	Druckgeschmiert	Graissage moteur	Lubrificazione forzata
L	With electrically controlled clutch	Mit elektrisch gesteuerter Kupplung	Avec embrayage commandé électriquement	Con frizione controllata elettricamente

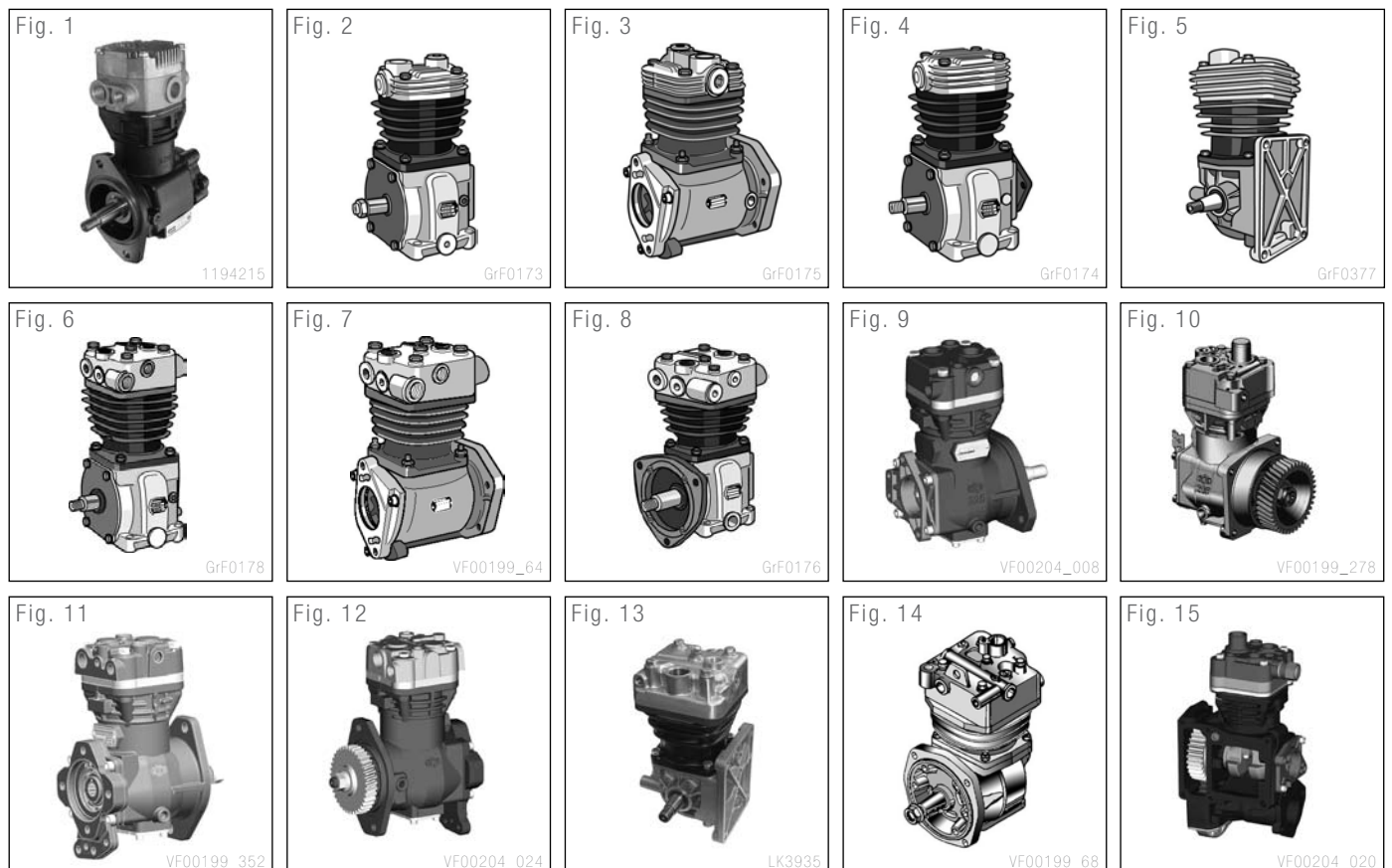

1 (1.1)

Compressors – Single Cylinder
Kompressoren – Einzylinder

Compresseurs – Monocylindres
Compressori – Monocilindrici

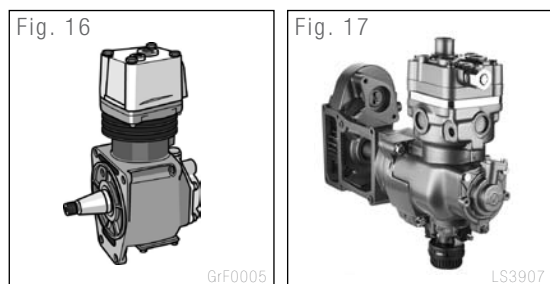

Part Number	Type Number	Fig.	A			B [cm³]	C Max [bar]	Legend
			2	4	9			
1194215X50	–	1	3/4" NPTF	–	3/8" NPTF	250		E, G, I, K
I86164	LK1311	2	M26x1,5	–	–	110	10,0	D, H, K
I87544	LK1314	2	M26x1,5	–	–	110		D, H, K
I92972	LK1534	2	M26x1,5	–	–	150	12,0	D, H, K
I98498	LK1545	2	M26x1,5	–	–	150	19,0	D, H, K
II17393	LK1560	2	M26x1,5	–	–	150	19,0	D, H, K
II38775F	LK1565	2	M26x1,5	–	–	150		D, H, K
II39151F	LK1566	2	M26x1,5	–	–	150	10,0	D, G, H, K
SEB01686000	LK1567	3	M26x1,5	–	–	150		E, G, H, K
K014774	LK1573	2	M26x1,5	–	–	150	10,0	D, H, K
I80864	LK1802	4	M26x1,5	–	–	225	10,0	D, H, K
II18355	LK1813	5	M26x1,5	–	–	225	10,0	D, G, H, K
II32224	LK3515	6	M26x1,5	–	M16x1,5	150	10,0	E, I, K
II39521F	LK3517	7	M26x1,5	–	M16x1,5	150	12,0	E, G, I, J, K
II34069	LK3826		M26x1,5	–	M22x1,5	213	12,5	F, I, K
SEB01586000	LK3833	8	M22x1,5	M10x1,25	M16x1,5	225	12,0	E, G, I, J, K
SEB01597000	LK3834	4	M22x1,5	M10x1,0	M16x1,5	225	12,0	E, G, I, J, K
K002141000	LK3840	9	M22x1,5	–	M16x1,5	225	12,5	E, G, I, K
K004640X00	LK3841	10	M18x1,5	–	M16x1,5	225	12,0	E, I, J, K
K000861000	LK3846	9	M22x1,5	–	M16x1,5	225	12,0	E, G, I, J, K
K017274	LK3846	9	M22x1,5	–	M16x1,5	225	12,0	E, G, I, J, K
K019284	LK3848	8	M22x1,5	M10x1,0	M16x1,5	225	12,0	E, G, I, J, K
SEB01768000	LK3850	11	M22x1,5	–	M16x1,5	225	12,0	E, G, I, J, K
K018385	LK3866	8	M26x1,5	–	M16x1,5	225	12,0	E, G, I, J, K
K001728000	LK3867	12	M22x1,5	–	M16x1,5	225	12,0	E, G, I, J, K
K016932	LK3869	9	M26x1,5	–	M16x1,5	225	12,0	E, G, I, J, K
K004852000	LK3872	8	M22x1,5	M10x1,0	M16x1,5	225	12,0	E, G, I, J, K
K008457000	LK3875	11	M22x1,5	–	M16x1,5	225		E, G, I, K
I94064	LK3927	8	M26x1,5	–	M22x1,5	300	12,5	E, G, J, K
II19494	LK3935	13	M26x1,5	–	M18x1,5	300	10,0	F, I, K
K040432N00	LK3947	14	M22x1,5	–	M16x1,5	300	10,0	E, G, I, K
K000741	LK3959	14	M18x1,5	M22x1,5	M16x1,5	300	10,0	E, G, I, K

Part Number	Type Number	Fig.	A			B [cm ³]	C Max [bar]	Legend
			2	4	9			
<i>II33163</i>	LK3965	8	M18x1,5	M22x1,5	M16x1,5	300	10,0	E, G, I, K
<i>II32223</i>	LK3966	8	M18x1,5	M22x1,5	M16x1,5	300	10,0	E, G, I, K
<i>II36925</i>	LK3980	7	M26x1,5	–	M22x1,5	300	12,5	E, G, I, K
<i>SEB01842000</i>	LK3994	9	M22x1,5	–	M16x1,5	360	12,0	E, G, I, J, K
<i>K015410</i>	LK8901	15	M26x1,5	–	M16x1,5	360	12,5	F, G, I, J, K
<i>K040960N00</i>	LK8905		M26x1,5	M10x1,0	M16x1,5	360	12,0	E, G, I, J, K
<i>SEB01151</i>	LP3860	16	M26x1,5	–	M18x1,5	248	10,0	E, J, K
<i>SEB01152000</i>	LP3861	16	M26x1,5	–	M18x1,5	248	10,0	E, G, J, K
<i>K003084000</i>	LP3955	9	M26x1,5	M10x1,0	M16x1,5	360	12,0	E, G, I, K
<i>K004641000</i>	LP3970	10	M18x1,5	–	M16x1,5	360	12,0	E, I, J, K
<i>K017428</i>	LP3974	8	M22x1,5	M10x1,0	M16x1,5	360	12,0	E, G, I, J, K
<i>SEB01791</i>	LP3974	8	M22x1,5	M10x1,0	M16x1,5	360	12,0	E, G, I, J, K
<i>K014799000</i>	LP3977	6	M26x1,5	–	M16x1,5	360	12,0	E, G, I, J, K
<i>K005977</i>	LP3986	15	M26x1,5	–	M16x1,5	360	12,0	E, G, I, J, K
<i>K015948</i>	LP3997	10	M26x1,5	–	M16x1,5	360	12,5	G, I, K
<i>K015518</i>	LP8701	8	M26x1,5	–	M22x1,5	300	10,0	E, G, I, K
<i>K035435N04</i>	LS3907	17	M26x1,5	–	M16x1,5	360	12,5	F, I, J, K, L

1 (1.2)

Compressors – Twin Cylinder
Kompressoren – Zweizylinder

Compresseurs – Bicylindres
Compressori – Bicilindrici

Legend	Legende	Légende	Legenda
A2	Delivery	Ausgang	Uscita
A4	Unloader	Steuerung	Comando
A9	Water	Kühlmittel	Acqua
B	Volume	Hubvolumen	Cilindrata
C	Delivery pressure	Betriebsdruck	Pressione d'uscita
D	Base mounted	Fußbefestigung	Fissaggio a basamento
E	Flange mounted	Flanschbefestigung	Fissaggio a flangia
F	Side mounted	Seitliche Befestigung	Fissaggio laterale
G	Through drive	Mit Durchtrieb	Con supporto pompa
H	Air cooled	Luftgekühlt	Raffreddato ad aria
I	Water cooled	Wassergekühlt	Testa raffreddata ad acqua
J	Water cooled valve plate	Ventilplatte wassergekühlt	Testa e piastra raffreddate ad acqua
K	Uses engine oil	Druckgeschmiert	Lubrificazione forzata
L	Uses own oil	Tauchgeschmiert	Lubrificazione autonoma
M	With ESS	Mit Energiespareinrichtung	Con energy saving
1)	Flange	Flansch	Flangia

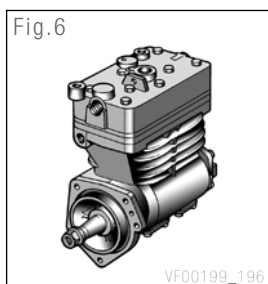
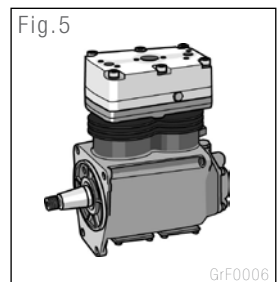
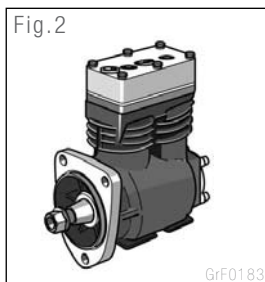

Compressors – Twin Cylinder
Kompressoren – Zweizylinder

Compresseurs – Bicylindres
Compressori – Bicilindrici

Part Number	Type Number	Fig.	A			B [cm ³]	C Max [bar]	Legend
			2	4	9			
109649	–	1	1/2" NPTF	1/8" NPTF	1/2" NPTF	299		E, G, I, M
1186722SP	–	2	¹⁾	M12x1,25	3/8" NPTF	440		E, I, K
1189106	–	2	¹⁾	M12x1,25	M18x1,5	440		E, I, K
1189107	–	2	¹⁾	M12x1,5	M16x1,5	440		E, I, K
1194456000	–	3	M26x1,5	–	M18x1,5	460	12,0	E, G, I, J, K
280737X50	–	2	¹⁾	1/8" NPTF	3/8" NPTF	272		E, I, K
286104X50	–	2	¹⁾	1/8" NPTF	3/8" NPTF	272		E, I, K
KZ433/1X50	–	2	¹⁾	1/8" NPTF	3/8" NPTF	440		E, I, K
KZ642/2X50	–	2	¹⁾	M12x1,5	M18x1,5	440		E, I, K
KZ1087/4	–	4	3/4"NPTF	–	1/2" NPTF	440		D, I, K
K001267000	LK4918	5	M26x1,5	–	M16x1,5	608	10,0	E, K, J,
K002029000	LK4919	6	M26x1,5	–	M16x1,5	608	13,0	E, G, I, K
K002032000	LK4920	6	M26x1,5	–	M16x1,5	608	13,0	E, I, K
K001268000	LK4921	6	M26x1,5	–	M16x1,5	608		E, J, K
II39523F	LK4927	6	M26x1,5	–	M16x1,5	608	13,0	E, I, K
K015965	LK4928	7	M26x1,5	–	M16x1,5	720	12,5	F, G, I, J, K
K009403000	LK4930	8	–	–	–	720	12,0	E, G, I, J, K
K000513	LK4932	5	M26x1,5	–	M16x1,5	600	12,5	E, G, I, K
K002123000	LK4935	6	M26x1,5	–	M18x1,5	630	14,0	E, G, I, K
K001126000	LK4936	6	M26x1,5	M12x1,5	M18x1,5	630	14,0	E, G, I, J, K
K022263N00	LK4936	6	M26x1,5	M12x1,5	M18x1,5	630	14,0	E, G, I, J, K
K001127000	LK4937	6	M26x1,5	–	M18x1,5	630	14,0	E, G, I, J, K
K001998	LK4939		M26x1,5	–	M16x1,5	600	12,5	E, G, I, K
K016615000	LK4941	6	M26x1,5	M22x1,5	M18x1,5	608	13,0	E, G, I, K, M
K017527000	LK4944	8	M26x1,5	M10x1,0	M16x1,5	720	12,0	E, G, I, K
K015309N04	LK4947	9	M26x1,5	–	M16x1,5	720	12,5	F, G, I, K
K009580000	LK4949	8	¹⁾	M10x1,0	¹⁾	720	12,5	E, I, K
K009581000	LK4951	8	¹⁾	M10x1,0	¹⁾	720	12,5	E, G, I, K
K024410N00	LK4951	8	¹⁾	M10x1,0	¹⁾	720	12,5	E, G, I, K
K002120000	LK4952	3	M26x1,5	–	M18x1,5	628	14,0	E, G, I, J, K
K022264N00	LK4952	3	M26x1,5	–	M18x1,5	628	14,0	E, G, I, J, K
K017528	LK4954	8	M26x1,5	M10x1,0	M16x1,5	720	12,0	G, E, I, K
K013739	LK4958	6	M26x1,5	M12x1,5	M18x1,5	628	14,0	E, G, I, K
K014371	LK4959	3	M26x1,5	M12x1,5	M18x1,5	630	12,0	E, G, I, K, M
K015108	LK4960	10	M26x1,5	–	M16x1,5	720	12,5	G, I, K
K018625000	LK4961	11	¹⁾	M10x1,0		720	12,5	E, I, K
K037049N00	LK4962	12	M26x1,5	M12x1,5	M18x1,5	630	12,0	E, G, I, K, M
K033412N00	LK4963	13	M26x1,5	–	M18x1,5	630	12,0	E, G, I, K
K026846N01	LK4968		M26x1,5	M10x1,5	M18x1,5	650	10,3	E, G, I, J, K, M
I83843	LP2983		M22x1,5	–	–	300	10,0	D, H, L

1 (1.2)

Compressors – Twin Cylinder
Kompressoren – Zweizylinder

Compresseurs – Bicylindres
Compressori – Bicilindrici

Part Number	Type Number	Fig.	A			B [cm ³]	C Max [bar]	Legend
			2	4	9			
I90499000	LP4813	2	M26x1,5	–	M16x1,5	440	12,5	E, I, K
I97492000	LP4814	2	M26x1,5	–	M16x1,5	440	12,5	E, J, K
I97493000	LP4815	2	M26x1,5	–	M16x1,5	440	12,5	E, J, K
	LP4818	5	M26x1,5	–	M18x1,5	384	10,0	E, G, I, K
	LP4823	2	M26x1,5	–	M14x1,5	440	12,5	E, I, K
II15993000	LP4825	2	M26x1,5	M22x1,5	M16x1,5	440	12,5	E, I, K, M
SEB01781	LP4830		M26x1,5	–	M18x1,5	440	12,5	E, I, K
SEB01245	LP4832	2	M26x1,5	–	M18x1,5	440	12,5	E, I, K
SE- B01485X00	LP4833	5	M26x1,5	–	M18x1,5	440	12,5	E, I, K
SE- B01392X00	LP4840	5	M26x1,5	–	M18x1,5	440	12,5	E, I, K
SEB01430	LP4843	5	M26x1,5	–	M18x1,5	440	12,5	E, I, K
	LP4845	6	M26x1,5	–	M18x1,5	500	12,5	E, J, K
II35564000	LP4850	6	M26x1,5	–	M16x1,5	440	12,5	E, I, K
	LP4851	2	M26x1,5	–	M18x1,5	500	12,5	E, J, K
SEB01588	LP4852		M26x1,5	–	M16x1,5	440	11,0	E, G, I, K
SEB01747	LP4855	6	M26x1,5	–	M18x1,5	500	12,5	E, G, J, K
K022249N00	LP4857	2	M26x1,5	M12x1,5	M18x1,5	460	14,0	E, G, I, J, K
K033392N00	LP4864	13	M26x1,5	–	M18x1,5	460	12,5	E, G, I, K
K033404N00	LP4865	12	M26x1,5	–	M18x1,5	460	12,0	E, G, I, K
K035001N00	LP4871	3	M26x1,5	–	M18x1,5	460	12,0	E, G, I, K
II30895	LP4934	2	M26x1,5	–	M22x1,5	600	13,0	E, I, J, K
	LP4939	5	M26x1,5	–	M18x1,5	330	10,0	E, I, K
	LP4941	5	M26x1,5	–	M18x1,5	330	10,0	E, I, K
	LP4943	5	M26x1,5	–	M18x1,5	330	10,0	E, J, K
	LP4944	5	M26x1,5	–	M18x1,5	384	12,5	E, I, K
K002975000	LP4957	6	M26x1,5	M22x1,5	M18x1,5	608	13,0	E, I, J, K, M
K000237000	LP4960	6	M26x1,5	M22x1,5	M16x1,5	608	13,0	E, I, J, K, M
II30900	LP4961	6	M26x1,5	M22x1,5	M16x1,5	608	12,5	E, J, K, M
K002046000	LP4964	6	M26x1,5	M22x1,5	M18x1,5	608	13,0	E, J, K, M
II33164000	LP4967	6	M26x1,5	M22x1,5	M16x1,5	608	13,0	E, I, J, K, M
II34404N00	LP4969		M26x1,5	–	M16x1,5	608	13,0	E, I, J, K
K000236000	LP4974	6	M26x1,5	M22x1,5	M16x1,5	608	13,0	E, J, K, M
	LP4983	6	M26x1,5	–	M16x1,5	608	13,0	E, I, K
	LP4984		M26x1,5	–	M16x1,5	608	13,0	E, I, K
K000229000	LP4985	6	M26x1,5	–	M16x1,5	608	13,0	E, J, K
K002031000	LP4992	6	M26x1,5	–	M16x1,5	608	13,0	E, J, K
SEB01676	LP4999	2	1-1/16"	7/8"-14	3/4"-16	608	13,0	E, J, K

Legend	Legende	Légende	Legenda
A2	Delivery	Ausgang	Uscita
A9	Water	Kühlmittel	Acqua
B	Water cooled head	Wasserkühlung (Kopf)	Testa raffreddata ad acqua
C	Complete with valve plate	Vollständig mit Sitzplatte	Completo di piastra
D	Supplied with gaskets	Mit Dichtungen geliefert	Fornito con guarnizioni

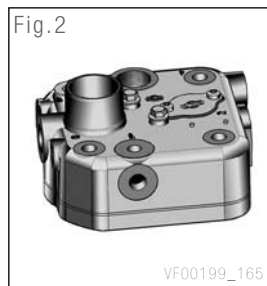
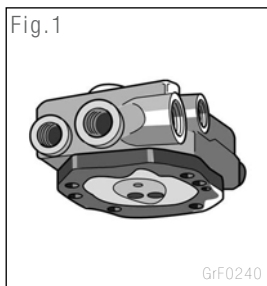

Part Number	Type Number	Fig.	A		Legend
			2	9	
II15615	–		M26x1,5	M22x1,5	B
II15616	–		M26x1,5	M22x1,5	B
K033367N50	ZB4275	1	M26x1,5	M22x1,5	B,C
II40284F000	ZB4289	2	M26x1,5	M22x1,5	B,C,D

Legend	Legende	Légende	Legenda
A1	Supply	Eingang	Alimentazione
A2	Delivery	Ausgang	Uscita
A4	Purge	Regeneration	Scarico
A ₅	Flange	Flansch	Flangia
B	Safety valve pressure	Öffnungsdruck Sicherheitsventil	Pressione della valvola di sicurezza
C	Unloader cut-out pressure or Signalled (C ₁)	Druckreglerabschaltdruck oder mit Steueranschluss (C ₁)	Pressione di scatto o Pilotato del regolatore (C ₁)
D	Heater voltage	Heizungsbetriebsspannung	Tensione del riscaldatore
E	Exhaust connector	Entlüftungsanschluss	Connessione di scarico
E ₁	Pipe 20mm	Stutzen 20mm	Tubo 20mm
E ₂	Pipe 31mm	Stutzen 31mm	Tubo 31mm
E ₃	Snap-on	Schnappanschluss	A innesto
E ₄	M22x1,5	M22x1,5	M22x1,5
E ₅	Pipe 16mm	Stutzen 16mm	Tubo 16mm
F	Exhaust silencer	Entlüftungsschalldämpfer	Silenziatore
F ₁	With internal silencer	Mit integriertem Schalldämpfer	Con Silenziatore integrato
F ₂	With external silencer	Mit externem Schalldämpfer	Con Silenziatore esterno
G	Electrical connector	Elektrischer Anschluss	Connessione elettrica
G ₁	Kostal M27x1,0 (2 x Ø4,0)	Kostal M27x1,0 (2 x Ø4,0)	Kostal M27x1,0 (2 x Ø4,0)
G ₂	Kostal M27x1,0 (2 x Ø4,0 + 1 x Ø4,5)	Kostal M27x1,0 (2 x Ø4,0 + 1 x Ø4,5)	Kostal M27x1,0 (2 x Ø4,0 + 1 x Ø4,5)
G ₃	Bayonet (2 x Ø4,0 + 1 x Ø4,5)	Bajonett (2 x Ø4,0 + 1 x Ø4,5)	Baionetta (2 x Ø4,0 + 1 x Ø4,5)
G ₄	Bayonet DIN 72585 (2 x Ø2,5)	Bajonett DIN 72585 (2 x Ø2,5)	Baionetta DIN 72585 (2 x Ø2,5)
G ₅	Volvo 'D' (2 x Ø3,5)	Volvo 'D' (2 x Ø3,5)	Volvo 'D' (2 x Ø3,5)
O	With OSC	Mit OSC	Con OSC
S	Semi Electronic	Semielektronisch	Semi Elettronico
T	Timed purge	Regeneration mit Zeitschalter	Spurgo temporizzato

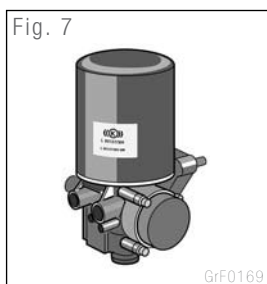
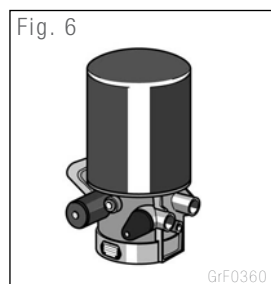
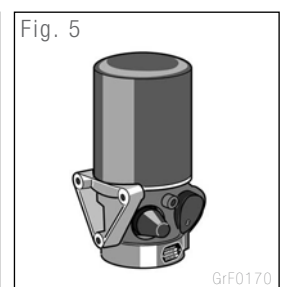
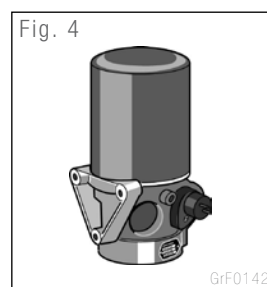
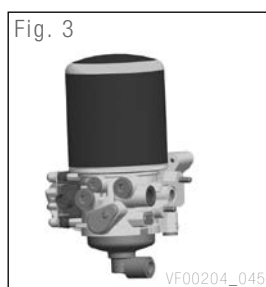

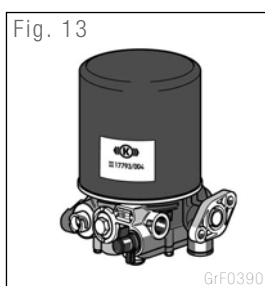
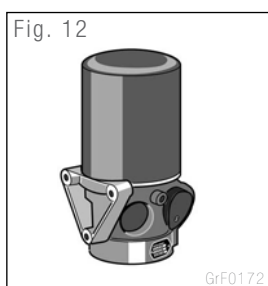

Part Number	Type Number	Fig.	A			B [bar]	C [bar]	D [V]	E	F	G	O	S	T
			1	2	4									
0484460165000	–	1	M22x1,5	M22x1,5	M12x1,5	22,0	18,3	24	E ₁		G ₁			
0484460170000	–	1	M22x1,5 Voss	M22x1,5 Voss	M16x1,5 Voss	13,5	9,8	24	E ₂		G ₃			
0484460171000	–	1	M22x1,5	M22x1,5	M12x1,5	13,5	8,8	24	E ₁		G ₁			
0484460177000	–	1	M22x1,5	M22x1,5	M12x1,5	13,5	9,8	24	E ₃	F ₁ ,F ₂	G ₁			
0484460196000	–	1	M22x1,5 Voss	M22x1,5 Voss	M16x1,5 Voss	13,5	9,8	24	E ₃		G ₃			
0484460202170	–	2	M22x1,5	M22x1,5	M12x1,5	22,0	18,3	24	E ₄		G ₁			
II41222FN00	EL9000	3	M22x1,5	A ₅	–	13,0	C ₁	–	E ₅		–		S	
K011482N00	EL9001	3	M22x1,5	A ₅	–	13,0	C ₁	–	E ₅		–		S	
K011867N00	EL9002	3	M22x1,5	A ₅	–	13,0	C ₁	–	E ₅		–		S	
I87501	LA6210	4	M22x1,5	M22x1,5	–	13,0	8,1	24	E ₃	F ₁	G ₁			
I92013	LA6221	5	M22x1,5	M22x1,5	M12x1,5	13,0	8,1	–	E ₃	F ₁				
K000065	LA6252	4	M22x1,5	M22x1,5	–	13,0	7,9	24	E ₃		G ₁			
II39867F	LA6277	5	M22x1,5	M22x1,5	M12x1,5	13,0	8,1	12	E ₃	F ₁	G ₁			
II36935000	LA6710	4	M22x1,5	M22x1,5	M12x1,5	17,0	C ₁	24	E ₃	F ₁	G ₅			
II36936000	LA6711	4	M22x1,5	M22x1,5	M12x1,5	17,0	C ₁	24	E ₃	F ₁	G ₁			
II19332N00	LA8001	6	M22x1,5	M22x1,5	–	13,0	8,6	24	E ₃		G ₁			T
II19333N00	LA8002	6	M22x1,5	M22x1,5	–	13,0	8,6	24	E ₃		G ₁			T
II19334N00	LA8003	6	M22x1,5	M22x1,5	–	13,0	9,5	24	E ₃		G ₁			T
II19335N00	LA8004	6	M22x1,5	M22x1,5	–	13,0	10,0	24	E ₃		G ₁			T
II19337N00	LA8006	6	M22x1,5	M22x1,5	–	13,0	8,6	24	E ₃		G ₁			T
II19338	LA8007	6	M22x1,5	M22x1,5	–	13,0	9,5	24	E ₃		G ₁			T
II19362N00	LA8008	6	M22x1,5	M22x1,5	–	15,5	12,2	24	E ₃		G ₁			T
K000479	LA8008	7	M22x1,5	M22x1,5	–	15,5	12,2	24	E ₃	F ₁	G ₁			T
II37926N00	LA8011	6	M22x1,5	M22x1,5	–	13,0	8,6	–	E ₃					T
II19369N00	LA8015	6	M22x1,5	M22x1,5	–	13,0	8,6	–	E ₃					T
II37927N00	LA8016	6	M22x1,5	M22x1,5	–	13,0	9,5	–	E ₃					T
II30455	LA8027	6	M22x1,5	M22x1,5	–	13,0	9,5	12	E ₃		G ₁			T
II30458	LA8028	6	M22x1,5	M22x1,5	–	13,0	8,3	24	E ₃	F ₁	G ₁			T
II31877	LA8032	6	M22x1,5	M22x1,5	–	13,0	8,6	24	E ₃		G ₁			T
II34976N00	LA8040	6	M22x1,5	M22x1,5	–	15,5	12,5	–	E ₃	F ₁				T
II37928N00	LA8041	6	M22x1,5	M22x1,5	–	15,5	12,5	–	E ₃	F ₁				T
II35526	LA8044	6	M22x1,5	M22x1,5	–	15,5	12,5	24	E ₃	F ₁	G ₁			T

Part Number	Type Number	Fig.	A			B [bar]	C [bar]	D [V]	E	F	G	O	S	T
			1	2	4									
II37924	LA8050	8	M22x1,5	M22x1,5	–	13,0	10,0	24	E ₃	F ₁	G ₁			T
K018395	LA8054	6	M22x1,5	M22x1,5	–	13,0	8,1	24	E ₃		G ₁			
II38786F	LA8057	6	M22x1,5	M22x1,5	–	13,0	8,6	24	E ₃	F ₁	G ₄			T
II38798F	LA8060	6	M22x1,5	M22x1,5	–	13,0	8,1	24	E ₃	F ₁	G ₁			T
II39054FN00	LA8061	8	M22x1,5	M22x1,5	–	15,5	12,5	24	E ₃	F ₁	G ₄			T
II40133F	LA8062	9	M22x1,5	M22x1,5	–	15,5	11,0	24	E ₃	F ₁	G ₄			T
K000754N00	LA8063	7	M22x1,5	M22x1,5	–	15,5	12,5	24	E ₃	F ₁	G ₄			T
K000755N00	LA8064	7	M22x1,5	M22x1,5	–	13,0	9,5	24	E ₃	F ₁	G ₄			T
K001056N00	LA8065	8	M22x1,5	M22x1,5	–	15,5	12,5	24	E ₃	F ₁	G ₄			T
K002135	LA8068	6	M22x1,5	M22x1,5	–	13,0	10,0	24	E ₃		G ₁			T
K004692	LA8069	8	M22x1,5	M22x1,5	–	15,5	12,2	24	E ₁	F ₁	G ₁			T
K016601N00	LA8073	8	M22x1,5	M22x1,5	–	15,5	12,5	24	E ₃	F ₁	G ₄	O		T
K016602N00	LA8074	7	M22x1,5	M22x1,5	–	13,0	9,5	24	E ₃	F ₁	G ₄	O		T
K020337N00	LA8075	6	M22x1,5	M22x1,5	–	15,5	12,5	–	E ₃	F ₁		O		T
K020338N00	LA8076	6	M22x1,5	M22x1,5	–	13,0	9,5	–	E ₃			O		T
II38302FN00	LA8104	10	M22x1,5	A ₅	–	13,0	11,0	24	E ₅		G ₄			T
II38303FN00	LA8105	10	M22x1,5	A ₅	–	13,0	11,0	–	E ₅					T
II38304FN00	LA8106	10	M22x1,5	A ₅	–	13,0	11,0	24	E ₅		G ₄			T
II38305FN00	LA8107	10	M22x1,5	A ₅	–	13,0	11,0	–	E ₅					T
II38620FN00	LA8116	11	M22x1,5	A ₅	–	13,0	10,0	24	E ₃	F ₁	G ₄			T
II40554FN00	LA8124	10	M22x1,5	A ₅	–	13,0	10,5	24	E ₅	F ₁	G ₄			T
II40555FN00	LA8125	10	M22x1,5	A ₅	–	13,0	10,5	24	E ₅	F ₁	G ₄			T
II40557FN00	LA8127	10	M22x1,5	A ₅	–	14,5	12,5	24	E ₅	F ₁	G ₄			T
II40558FN00	LA8128	10	M22x1,5	A ₅	–	14,5	12,5	24	E ₅	F ₁	G ₄			T
II40559FN00	LA8129	10	M22x1,5	A ₅	–	14,5	12,5	24	E ₅	F ₁	G ₄			T
K000390N00	LA8130	11	M22x1,5	A ₅	–	13,0	10,4	24	E ₃	F ₁	G ₄			T
K000391N00	LA8131	11	M22x1,5	A ₅	–	13,0	10,4	24	E ₃	F ₁	G ₄			T
K000392N00	LA8132	11	M22x1,5	A ₅	–	13,0	10,4	24	E ₃	F ₁	G ₄			T
K002148N00	LA8136	10	M22x1,5	A ₅	–	13,0	11,0	24	E ₅		G ₄			T
K011984N00	LA8137	11	M22x1,5	A ₅	–	13,0	10,4	24	E ₃	F ₁ ,F ₂	G ₄			T
K011985N00	LA8138	11	M22x1,5	A ₅	–	13,0	10,4	24	E ₃	F ₁ ,F ₂	G ₄			T
K013767N00	LA8140	10	M22x1,5	A ₅	–	13,0	11,0	24	E ₅	–	G ₄			T
K013768N00	LA8141	10	M22x1,5	A ₅	–	13,0	11,0	–	E ₅	–	–			T
K013769N00	LA8142	10	M22x1,5	A ₅	–	13,0	11,0	24	E ₅	–	G ₄			T
K013770N00	LA8143	10	M22x1,5	A ₅	–	13,0	11,0	–	E ₅	–	–			T
K014319N00	LA8144	10	M22x1,5	A ₅	–	13,0	11,0	24	E ₅	–	G ₄			T
K014986N00	LA8145	11	M22x1,5	A ₅	–	13,0	10,4	24	E ₃	F ₁ ,F ₂	G ₄	O		T
K014981N00	LA8146	11	M22x1,5	A ₅	–	13,0	10,4	24	E ₃	F ₁	G ₄	O		T
K014980N00	LA8147	11	M22x1,5	A ₅	–	13,0	10,4	24	E ₃	F ₁ ,F ₂	G ₄	O		T
K033356	LA8156	10	M22x1,5	A ₅	–	12,0	11,0	24	E ₅		G ₄			

Part Number	Type Number	Fig.	A			B [bar]	C [bar]	D [M]	E	F	G	O	S	T
			1	2	4									
K033952	LA8157	10	M22x1,5	A ₅	–	12,0	10,5	24	E ₅		G ₄			
II19216	LA8205	6	M22x1,5	M22x1,5	M16x1,5 Voss	14,5	12,0	–	E ₁	F ₁				
II19375	LA8206	6	M22x1,5	M22x1,5 Voss	M16x1,5 Voss	13,0	9,8	24	E ₃	F ₁	G ₃			
II19204	LA8207	9	M22x1,5 Voss	M22x1,5 Voss	M16x1,5 Voss	13,0	8,5	–	E ₃	F ₁				
II19205	LA8208	8	M22x1,5 Voss	M22x1,5 Voss	M16x1,5 Voss	13,0	8,5	24	E ₃	F ₁	G ₄			
II19206	LA8209	9	M22x1,5 Voss	M22x1,5 Voss	M16x1,5 Voss	13,0	10,0	–	E ₃	F ₁				
II19207	LA8210	8	M22x1,5 Voss	M22x1,5 Voss	M16x1,5 Voss	13,0	10,0	24	E ₃	F ₁	G ₄			
II19208	LA8211	9	M22x1,5 Voss	M22x1,5 Voss	M16x1,5 Voss	15,5	12,5	–	E ₃	F ₁				
II19209	LA8212	8	M22x1,5 Voss	M22x1,5 Voss	M16x1,5 Voss	15,5	12,5	24	E ₃	F ₁	G ₄			
II19483N00	LA8219	6	M22x1,5	M22x1,5	M12x1,5	15,5	11,0	–	E ₃	F ₁				
II19484N00	LA8220	6	M22x1,5	M22x1,5	M12x1,5	15,5	11,0	24	E ₃	F ₁	G ₃			
II19485N00	LA8221	6	M22x1,5	M22x1,5	M12x1,5	17,0	12,5	–	E ₃	F ₁				
II19486N00	LA8222	6	M22x1,5	M22x1,5	M12x1,5	17,0	12,5	24	E ₃	F ₁	G ₃			
II30178	LA8223	6	1/2" NPTF	1/2" NPTF	1/4" NPTF	13,0	8,4	24	E ₃	F ₁	G ₁			
II30182	LA8224	6	M22x1,5	M22x1,5	M12x1,5	13,0	8,4	24	E ₃	F ₁	G ₃			
II30179	LA8225	6	M22x1,5	M22x1,5	M12x1,5	13,0	8,1	24	E ₃	F ₁	G ₁			
II30180	LA8226	6	M22x1,5	M22x1,5	M12x1,5	13,0	8,4	24	E ₃	F ₁	G ₁			
II30181	LA8227	6	M22x1,5	M22x1,5	M12x1,5	13,0	10,0	24	E ₃	F ₁	G ₁			
II30185	LA8228	6	M22x1,5	M22x1,5	M12x1,5	13,0	8,1	–	E ₁	F ₁				
II30443N00	LA8229	6	M22x1,5	M22x1,5	M12x1,5	13,0	9,5	–	E ₃	F ₁				
II30444	LA8230	6	M22x1,5	M22x1,5	M12x1,5	13,0	10,0	24	E ₃	F ₁	G ₁			
II30447	LA8233	6	M22x1,5	M22x1,5	M12x1,5	15,5	12,5	24	E ₃	F ₁	G ₁			
K004564	LA8233	6	M22x1,5	M22x1,5	M12x1,5	15,5	12,5	24	E ₃	F ₁ ,F ₂	G ₂			
II30448	LA8234	6	M22x1,5	M22x1,5	M12x1,5	13,0	8,1	24	E ₃	F ₁	G ₁			
II30657	LA8239	6	M22x1,5	M22x1,5	M12x1,5	13,0	7,35	–	E ₃	F ₁				
II30650N00	LA8242	6	M22x1,5	M22x1,5	M12x1,5	15,5	11,0	24	E ₁	F ₁	G ₁			
II30810	LA8245	6	M22x1,5	M22x1,5	M12x1,5	13,0	8,5	24	E ₃	F ₁	G ₁			
II31112	LA8250	6	M22x1,5	M22x1,5	M12x1,5	13,0	7,35	24	E ₃	F ₁	G ₁			
II31119	LA8253	6	M22x1,5	M22x1,5	M12x1,5	13,0	8,1	–	E ₃	F ₁				
II31475	LA8254	5	M22x1,5	M22x1,5	M12x1,5	15,5	12,5	–	E ₃	F ₁				
II31481	LA8259	6	M22x1,5	M22x1,5	M12x1,5	13,0	8,3	24	E ₃	F ₁	G ₁			
II35522	LA8269	6	M22x1,5	M22x1,5	M12x1,5	13,0	8,1	24	E ₃	F ₁	G ₁			
II35523	LA8270	6	M22x1,5 Voss	M22x1,5 Voss	M16x1,5 Voss	13,0	10,0	24	E ₃	F ₁ ,F ₂	G ₁			
II39751F00	LA8271	6	M22x1,5	M22x1,5	M12x1,5	13,0	8,5	24	E ₃	F ₁	G ₅			

Part Number	Type Number	Fig.	A			B [bar]	C [bar]	D [V]	E	F	G	O	S	T
			1	2	4									
II36257N00	LA8272	6	M22x1,5	M22x1,5	M12x1,5	15,5	11,0	24	E ₃	F ₁	G ₄			
II39752F00	LA8286	6	M22x1,5	M22x1,5	M12x1,5	17,0	12,0	24	E ₃	F ₁	G ₅			
K000336	LA8289	1	M22x1,5	M22x1,5	M12x1,5	13,5	9,8	24	E ₃	F ₁	G ₁			
K002174	LA8298	9	M22x1,5	M22x1,5	M12x1,5	13,5	10,0	24	E ₃	F ₁	G ₁			
K007770N00	LA8509	8	M22x1,5	M22x1,5	M22x1,5	15,5	11,0	–	E ₃	F ₁				
K007771N00	LA8510	8	M22x1,5	M22x1,5	M22x1,5	15,5	11,0	24	E ₃	F ₁	G ₃			
K013479	LA8517	2	M22x1,5	M22x1,5	M12x1,5	22,0	18,3	24	E ₄		G ₄			
K017711	LA8543	8	M22x1,5	M22x1,5 Voss	M12x1,5 Voss	15,5	12,5	24	E ₃	F ₁	G ₄	O		
K017294	LA8544	1	M22x1,5	M22x1,5	M12x1,5	13,5	9,6	24	E ₁		G ₁			
K022369	LA8545	8	M22x1,5	M22x1,5	M12x1,5	13,0	7,35	24	E ₃	F ₁	G ₄			
K018578	LA8546	8	M22x1,5	M22x1,5		13,0	8,0	24	E ₃	F ₁	G ₄			
K023400	LA8547	8	M22x1,5	M22x1,5		13,0	8,9	24	E ₃	F ₁	G ₃			
K028030	LA8555	8	M22x1,5	M22x1,5 Voss	M12x1,5 Voss	13,0	10,0	24	E ₃	F ₁	G ₄			
K023357	LA8702	12	M22x1,5 Voss	M22x1,5 Voss	M12x1,5 Voss		C ₁		E ₁	F ₁				
K025606	LA8704	4	M22x1,5 Voss	M22x1,5 Voss	M12x1,5 Voss		C ₁	24	E ₁	F ₁	G ₁			
II36007	LA9004	1	M22x1,5	M22x1,5, A ₅	M16x1,5 Voss	14,0	12,3	24	E ₁		G ₄			
II38308FN00	LA9010	14	M22x1,5	M22x1,5, A ₅	M16x1,5 Voss	14,5	12,3	24	E ₁		G ₄			
II38309FN00	LA9011	13	M22x1,5	M22x1,5, A ₅	M16x1,5 Voss	14,5	12,3	–	E ₁		–			
K024486	LA9013	13	M22x1,5	M22x1,5, A ₅	M10x1,0	14,0	10,4	24	E ₃	F ₂	G ₄			
K002740N00	LA9018	13	M22x1,5	A ₅	M16x1,5 Voss	12,5	10,0	24	E ₁		G ₄	O		
K010514	LA9024	13	M22x1,5	A ₅	M16x1,5 Voss	14,5	11,5	24	E ₁		G ₄	O		
K024634N00	LA9034	13	M22x1,5	A ₅	M16x1,5 Voss	14,5	12,3	24	E ₁		G ₄	O		
K024635N00	LA9035	13	M22x1,5	A ₅	M16x1,5 Voss	12,5	10,0	24	E ₁		G ₄	O		

Legend	Legende	Légende	Legenda
A Air dryer	Lufttrockner	Dessiccateur d'air	Essiccatore
B Four circuit protection valve	Vierkreisschutzventil	Valve de protection 4 circuits	Valvola protezione a 4 vie
O With OSC	Mit OSC	Avec OSC	Con OSC
S Semi Electronic	Semielektronisch	Semi électronique	Semi Elettronico

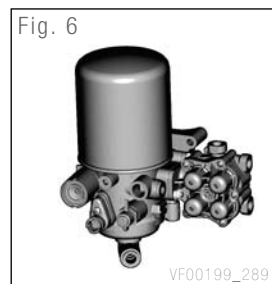
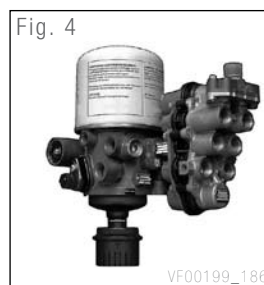
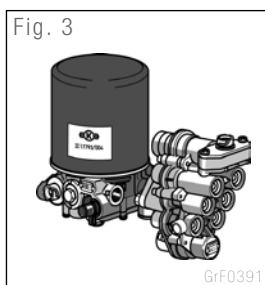
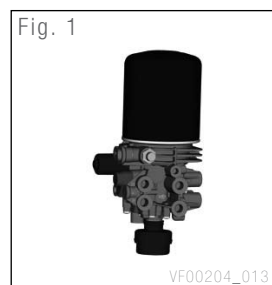

Part Number	Type Number	Fig.	A		B		O	S
			Part Number	Type Number	Part Number	Type Number		
K002241	ZB4400	1	Monobloc		Monobloc			
K004997	ZB4402	1	Monobloc		Monobloc			
K005280	ZB4403	1	Monobloc		Monobloc			
K007044	ZB4412	1	Monobloc		Monobloc		O	
K007498	ZB4414	1	Monobloc		Monobloc			
K009355	ZB4417	1	Monobloc		Monobloc		O	
K028205	ZB4418	1	Monobloc		Monobloc		O	
K028206	ZB4420	1	Monobloc		Monobloc		O	
K009740	ZB4422	1	Monobloc		Monobloc			
K010593	ZB4424	1	Monobloc		Monobloc			
K028207	ZB4427	1	Monobloc		Monobloc		O	
K010515	ZB4528	2	K010514	LA9024	II38797F	AE4506		
II38310FN00	ZB4534	3	II38308FN00	LA9010	II37680N50	AE4510		
II38619FN00	ZB4544	4	II38620FN00	LA8116	II39010FN50	AE4526		
II39866F	ZB4564	2	II36007	LA9004	II38797F	AE4506		
K000394N00	ZB4578	4	K000390N00	LA8130	II37464N50	AE4528		
K000395N00	ZB4579	5	K000391N00	LA8131	II38749F	AE4529		
K000396N00	ZB4580	5	K000392N00	LA8132	II37464N50	AE4528		
K012242N00	ZB4586	5	II40554FN00	LA8124	K011931	AE4502		
K012243N00	ZB4587	5	II40555FN00	LA8125	K011931	AE4502		

Part Number	Type Number	Fig.	A		B		O	S
			Part Number	Type Number	Part Number	Type Number		
K012244N00	ZB4588	5	II40556FN00	LA8126	K011931	AE4502		
K001449N00	ZB4589	2	II40557FN00	LA8127	II38677F	AE4503		
K001450N00	ZB4590	2	II40558FN00	LA8128	II38677F	AE4503		
K001453N00	ZB4591	2	II40559FN00	LA8129	II38677F	AE4503		
K012245N00	ZB4592	2	II40554FN00	LA8124	K011932N50	AE4516		
K012246N00	ZB4593	2	II40555FN00	LA8125	K011932N50	AE4516		
K012247N00	ZB4594	2	II40556FN00	LA8126	K011932N50	AE4516		
K001457N00	ZB4595	2	II40557FN00	LA8127	II37463	AE4527		
K001458N00	ZB4596	2	II40558FN00	LA8128	II37463	AE4527		
K001459N00	ZB4597	5	II40559FN00	LA8129	II37463	AE4527		
K001982N00	ZB4600	6	II38302FN00	LA8104	II37461N50	AE4608		
K001983N00	ZB4601	6	II38303FN00	LA8105	II37461N50	AE4608		
K001984N00	ZB4602	6	II38304FN00	LA8106	II37461N50	AE4608		
K001985N00	ZB4603	6	II38305FN00	LA8107	II37461N50	AE4608		
K002149N00	ZB4606	6	K002148N00	LA8136	K002147	AE4629		
K006066N00	ZB4607	6	K014319N00	LA8144	II37461N50	AE4608		
K013763N00	ZB4608	6	K013767	LA8140	II37461N50	AE4608		
K013764N00	ZB4609	6	K013768	LA8141	II37461N50	AE4608		
K013765N00	ZB4610	6	K013769	LA8142	II37461N50	AE4608		
K013766	ZB4611	6	K013770	LA8143	II37461N50	AE4608		
K011986N00	ZB4700	4	K011984N00	LA8137	II39010FN50	AE4526		
K011987N00	ZB4701	4	K011985N00	LA8138	II39010FN50	AE4526		
K014682N00	ZB4706	4	K014986	LA8145	II37464N50	AE4528	O	
K014683N00	ZB4707	4	K014981	LA8146	II38749F	AE4529	O	
K014684N00	ZB4708	4	K014980	LA8147	II37464N50	AE4528	O	
K025294N00	ZB4721	2	K024634N00	LA9034	II37680N50	AE4510	O	
K031708N03	ZB4723	5	K033356	LA8156	K026822	AE4544		
K033949N00	ZB4724	5	K033952	LA8157	K011932N50	AE4516		
K002736N00	ZB4803	7	K024635N00	LA9035	K002435N50	AE4800		
K025295N00	ZB4809	7	K024635N00	LA9035	K002435N50	AE4800	O	
K012576	ZE4501	5	K011867N00	EL9002	K011932N50	AE4516		S
II41221F	ZE4600	6	II41222FN00	EL9000	II37461N50	AE4608		S
K011481	ZE4601	6	K011482N00	EL9001	II37461N50	AE4608		S

Legend		Legende	Légende	Legenda
A1	Supply	Eingang	Alimentation	Alimentazione
A12	External supply connection	Externer Füllanschluss	Alimentation externe	Connettore alimentazione esterna
A2	Delivery (ports 21 – 26)	Ausgang (Anschlüsse 21 – 26)	Sortie (orifices 21 – 26)	Uscita (porte 21 – 26)
A4	Control (port 4/27)	Steuerung (Anschluss 4/27)	Pilotage (orifice 4/27)	Comando (porta 4/27)
A6	Pressure from spring brake system	Druck vom Feststellbremssystem	Contrôle pression frein de parc	Pressione dal circuito di stazionamento
B	Unloader cut-out pressure	Druckreglerabschaltdruck	Pression de déclenchement	Pressione di scatto
C	Heater voltage	Heizungsbetriebsspannung	Voltage de chauffage	Tensione del riscaldatore
D	Electrical connector	Elektrischer Anschluss	Connecteur électrique	Connettore elettrico
E ₁	Exhaust connector - pipe Ø19 mm	Entlüftungsanschluss - Stutzen Ø19 mm	Connecteur d'échappement - Tuyau Ø19 mm	Connettore di scarico - Tubo Ø19 mm
E ₂	Exhaust snap-on connector	Entlüftung mit Schnappanschluss	Connecteur d'échappement encliquetable	Connettore di scarico a innesto rapido
F	Vehicles with trailer control	Fahrzeuge mit Anhängersteuerung	Véhicules avec commande de la remorque	Veicoli con comando rimorchio
G	Vehicles without trailer control	Fahrzeuge ohne Anhängersteuerung	Véhicules sans commande de la remorque	Veicoli senza comando rimorchio
O	With OSC	Mit OSC	Avec OSC	Con OSC

Fig. 1



Fig. 2



Part Number	Type Number	Fig.	A					B [bar]	C [V]	D	Legend
			1	12	2	4	6				
K020741N50	EL1100	1	M22x1,5	M16x1,5	M22x1,5	M16x1,5	M16x1,5	12,5	–	DIN 72585 – 7 pin	E ₁ , F, O
K020742N50	EL1101	1	M22x1,5	M16x1,5	M22x1,5	M16x1,5	M16x1,5	12,5	–	DIN 72585 – 7 pin	E ₁ , G, O
K007331	EL2201	2	M22x1,5	–	M22x1,5	M16x1,5	–	13	24	Tyco – 16 pin	E ₂ , F
K015444	EL2203	2	M22x1,5	–	M22x1,5	M16x1,5	–	13	–	Tyco – 16 pin	E ₂ , F
K033209N01	EL2201	2	M22x1,5	M22x1,5	M22x1,5	M16x1,5	–	13	24	Tyco – 16 pin	E ₂ , F, O
K033210N01	EL2203	2	M22x1,5	M22x1,5	M22x1,5	M16x1,5	–	13	–	Tyco – 16 pin	E ₂ , F, O

NOTE: These products must be calibrated after replacement by using diagnostics (e.g. NEO System Diagnostics, see Section 51.1).

ACHTUNG: Diese Produkte müssen nach dem Austausch mit Hilfe von Diagnosesystemen kalibriert werden (z.B. NEO System Diagnose, siehe Abschnitt 51.1).

NOTE: Ces produits doivent être recalibrés après remplacement en utilisant un outil de diagnostic (ex. NEO Systems Diagnostics, voir Section 51.1).

NOTA: Dopo la sostituzione questi prodotti devono essere calibrati con uno strumento diagnostico (es: Sistema NEO, vedi sezione 51.1).

5

Alcohol Injectors Frostschutzmittelpumpen

Pompe Antigeli Anticongelatori

Legend	Legende	Légende	Legenda
A	Port size	Anschlussgewinde	Raccord
B	Bottle size	Behältervolumen	Capacità del serbatoio
S	Signalled	Mit Steueranschluss	Pilotato



Part Number	Type Number	Fig.	A	B [cm³]	Legend
0484451013000	–	1	M22&M12x1,5	1200	S
0484451019000	–	2	M22x1,5	450	
I82291	LA4115	3	M22x1,5	500	
I90375	LA4116	3	M22x1,5	500	
I82293	LA4117	3	M22&M12x1,5	300	S
I90186	LA4127	4	M22x1,5	250	
I98916	LA4129	3	M22x1,6	501	
I94650	LA4135	3	M22x1,5	500	

Legend	Legende	Légende	Legenda
A Thread size	Anschlussgewinde	Raccord	Filettatura



Part Number	Type Number	Fig.	A
0481019101000	–	1	M22x1,5
1031187000	–		M22x1,5
AC951A	–	2	M22x1,5

7

Filters / Desiccant Cartridges
Luftfilter / Trockenmittelpatronen

Filtres / Cartouches
Filtri / Cartucce

	Page
7.1 Filters	29
7.2 Desiccant Cartridges	30
	Seite
7.1 Luftfilter	29
7.2 Trockenmittelpatronen	30
	Page
7.1 Filtres	29
7.2 Cartouches	30
	Pagina
7.1 Filtri	29
7.2 Cartucce	30

	Legend	Legende	Légende	Legenda
A1	Supply	Eingang	Alimentation	Alimentazione
A2	Delivery	Ausgang	Sortie	Uscita
B	Operating pressure	Betriebsdruck	Pression de fonctionnement	Pressione di esercizio

Fig.1



Fig.2



Part Number	Type Number	Fig.	A		B Max [bar]
			1	2	
226908N	-	1	1/4" NPTF	1/4" NPTF	
I99660	LA2103	2	M22x1,5	M22x1,5	20,0

7 (7.2)

Desiccant Cartridges Trockenmittelpatronen

Cartouches Cartucce

Legend	Legende	Légende	Legenda	
A	Maximum operating pressure	Maximaler Arbeitsdruck	Pression maxi de service	Pressione massima di esercizio
B1	Right hand thread	Rechtsgewinde	Filetage pas à droite	Avvitamento senso orario
B2	Left hand thread	Linksgewinde	Filetage pas à gauche	Avvitamento senso antiorario
C	Height	Höhe	Taille	Altezza
O	OSC (with oil separator element)	OSC (mit Ölabscheider)	OSC (avec élément séparateur d'huile)	OSC (con elemento separatore d'olio)



Part Number	Type Number	Fig.	A [bar]	B		C [mm]	O
				1	2		
1507434000000	–	1	13	3/4" UNF	–	123	–
286968X50	–	2	12	7/16" UNC	–	–	–
II38789F004	–	3	20	M42x1,5	–	165	–
II40100F	–	3	14	M39x1,5	–	165	–
II41300F	–	4	14	M41x1,5	–	135	–
K039453	–	5	14	–	M39x1,5	165	O
K039454	–	5	14	M39x1,5	–	165	O
K039455	–	5	14	M41x1,5	–	165	O

Legend		Legende		Légende		Legenda	
A1	Supply	Eingang		Alimentation		Alimentazione	
A4	Control	Steuerung		Pilotage		Comando	
B	Automatic	Automatisch		Automatique		Automatico	
C	Manual	Manuell		Manuel		Manuale	

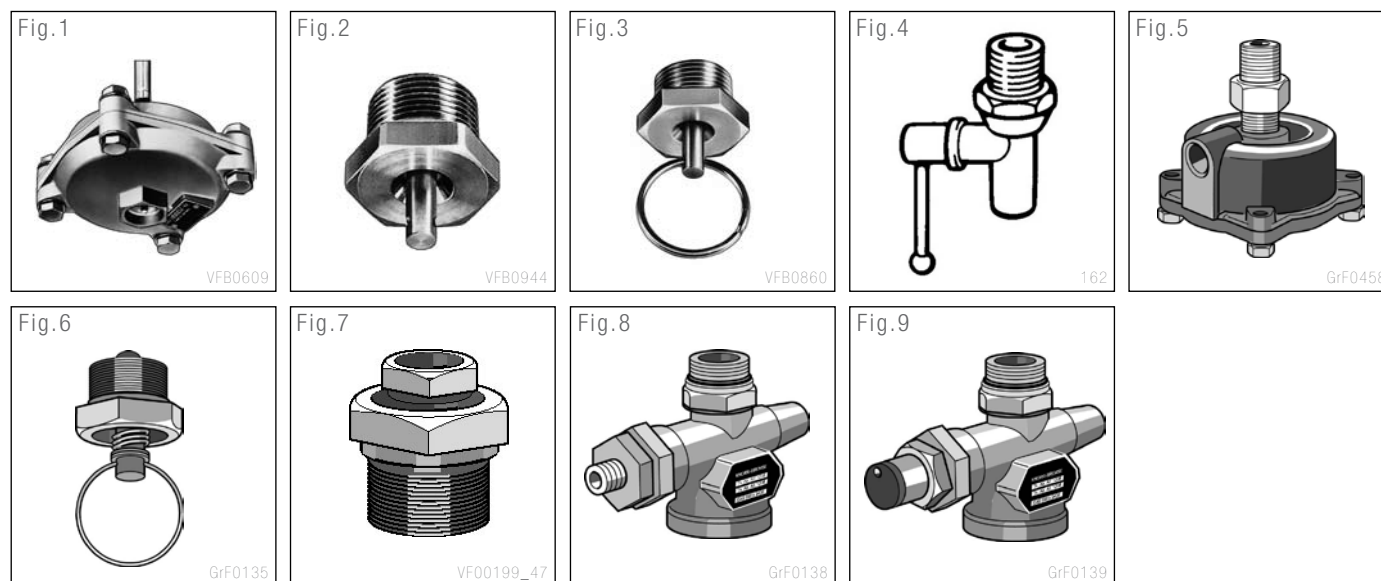

Part Number	Type Number	Fig.	A		Legend
			1	4	
0481019003000	-	1	M22x1,5	-	B
0481019007000	-	2	M22x1,5	-	C
0481019008000	-	3	M22x1,5	-	C
1111695000	-	4	M22x1,5	-	C
KW2350/1	-	3	1/2" NPTF	-	C
KW2350/2	-	3	M22x1,5	-	C
KW718/2	-	4	1/4" NPTF	-	C
KX2068/2	-	5	3/8" NPTF	-	B
KX2068/5	-	5	1/4" NPTF	-	B
KX2068/8	-		M16x1,5	-	B
VA12A	-	3	M22x1,5	-	C
I94095	EE1100	6	M22x1,5	-	C
SEB00224R	EE1100	6	M22x1,5	-	C
I16438	EE1101		M22x1,5	-	C
I85893	EE1106	7	M20x1,5	-	C
I74772	EE4103	8	M22x1,5	M12x1,5	B
I84866	EE4104	8	M22x1,5	M12x1,5	B
I116096	EE4106	8	M22x1,5	M12x1,5	B
I82646	EE4107	8	M22x1,5	M12x1,5	B
K000745	EE4107	8	M22x1,5	M22x1,5	B

8

Drain Valves
Entwässerungsventile

Valves de Purge
Valvole di Spurgo

Part Number	Type Number	Fig.	A		Legend
			1	4	
I92054	EE4115	8	M22x1,5	M22x1,5	B
II16095	EE4206	9	M22x1,5	–	B
II36087	EE4207	9	M22x1,5	–	B

Legend	Legende	Légende	Legenda
A1	Supply	Eingang	Alimentazione
A2	Delivery	Ausgang	Uscita
B	Cut-out pressure	Abschaltdruck	Scatto
C	Control range	Schaltspanne	Delta di pressione
D	Non waterproof	nicht wasserdicht	Non immergibile



Part Number	Type Number	Fig.	A		B [bar]	C [bar]	D
			1	2			
1185145	–	1	1/8" NPTF	1/8" NPTF	8,8	0,8	
1189393000	–	1	M10x1,0	M10x1,0	7,9	0,8	
1189394000	–	1	M10x1,0	M10x1,0	8,1	0,8	
1189395000	–	1	M10x1,0	M10x1,0	8,5	0,8	
1189396000	–	1	M10x1,0	M10x1,0	12,0	1,35	
1189489000	–	1	M10x1,0	M10x1,0	10,0	0,95	
267098	–	2	M10x1,0	M10x1,0	8,6	0,95	D
275491DK	–	1	1/8" NPTF	1/8" NPTF	8,3	0,8	
275508DK	–	1	1/8" NPTF	1/8" NPTF	7,6	0,8	
277486DK	–	1	1/8" NPTF	1/8" NPTF	9,0	0,9	
K018097	–	1	M10x1,0	M10x1,0	9,5	0,9	
K019929	–	1	1/8" NPTF	1/8" NPTF	9,3	1,4	

Legend	Legende	Légende	Legenda
A1	Supply	Eingang	Alimentation
A2	Delivery	Ausgang	Sortie
B	Cut-out pressure	Abschaltdruck	Pression de déclenchement
B ₁	External signal	Externes Signal	Signal externe
C	Cut-in pressure	Einschaltdruck	Pression de réenclenchement
D	Safety valve pressure	Druck Sicherheitsventil	Valve de sécurité
E	Signalling port M12x1,5	Steueranschluß M12x1,5	Raccord M12x1,5 pour signalisation
F	Tyre inflator port M16x1,5	Reifenfüllanschluss M16x1,5	Raccord M16x1,5 pour gonflage des roues

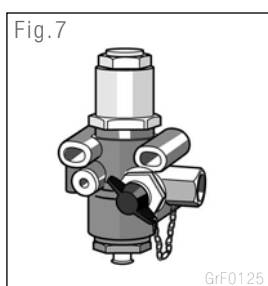
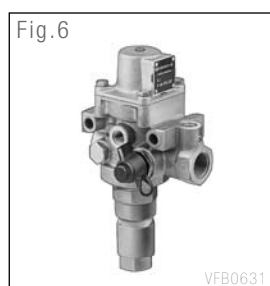
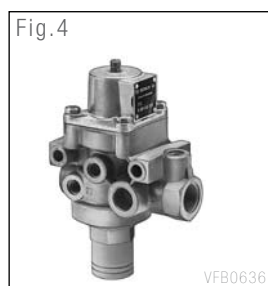

Part Number	Type Number	Fig.	A		B [bar]	C [bar]	D [bar]	Legend
			1	2				
0481039210000	–	1	M22x1,5	M22x1,5	8,0	7,4	12,0	F
0481039218000	–	1	M22x1,5	M22x1,5	7,8	7,2	12,0	F
0481039219000	–	2	M22x1,5	M22x1,5	9,5	8,8	13,5	E
0481039221000	–	1	M22x1,5	M22x1,5	8,1	7,5	12,0	E,F
0481039234000	–	1	M22x1,5	M22x1,5	8,1	7,5	13,5	E,F
0481039240000	–	1	M22x1,5	M22x1,5	8,5	7,9	11,5	E,F
0481039241000	–	1	M22x1,5	M22x1,5	8,5	7,9	12,0	E,F
0481039251000	–	1	M22x1,5	M22x1,5	7,35	6,75	12,0	
0481039266000	–	3	M22x1,5	M22x1,5	7,0	6,3	9,0	–
0481042201000	–	4	M22x1,5	M22x1,5	16,5	14,0	20,0	E
0481042208000	–	5	M22x1,5	M22x1,5	16,0	15,0	20	
0481042209000	–	4	M22x1,5	M22x1,5	12,0	10,1	15,0	E
0481042212000	–	4	M22x1,5	M22x1,5	18,3	15,8	22,0	E
0481042225000	–	2	M22x1,5	M22x1,5	11,0	10,3	15,5	–

Part Number	Type Number	Fig.	A		B [bar]	C [bar]	D [bar]	Legend
			1	2				
K022821	–	6	M22x1,5	M22x1,5	8,1	7,5	12,0	F
K029225	–	1	M22x1,5	M22x1,5	6,8	6,3	12,0	E,F
K036496	–	1	M22x1,5	M22x1,5	B ₁		12,0	E,F
0481039222000	DR3201	1	M22x1,5	M22x1,5	7,3	6,8	12,0	E,F
0481039242000	DR3203	7	M22x1,5	M22x1,5	5,6	4,8	13,0	F
0481039252000	DR3218	2	M22x1,5	M22x1,5	7,35	6,85	12,0	E
0481039257000	DR3224	2	M22x1,5	M22x1,5	8,1	7,5	13,5	E
0481039258000	DR3232	2	M22x1,5	M22x1,5	9,5	8,7	10,5	E
0481039201000	DR3500	1	M22x1,5	M22x1,5	8,1	7,5	12,0	E,F
0481039209000	DR3502	1	M22x1,5	M22x1,5	8,1	7,5	12,0	E,F
0481039213000	DR3503	1	M22x1,5	M22x1,5	10,0	9,3	13,5	E,F
0481039235000	DR3510	5	M22x1,5	M22x1,5	8,1	7,5	12,0	
0481039268100	DR3575	5	M22x1,5	M22x1,5	8,5	7,9	12,0	

11

Pressure Protection Valves
Überströmventile und Mehrkreisschutzventile

Valves de Protection (Simple et Multi Circuit)
Valvole a Pressione Controllata

	Page
11.1 Charging Valves (Overflow Valves)	37
11.2 Multi Circuit Protection Valves	39
	Seite
11.1 Überströmventile	37
11.2 Mehrkreisschutzventile	39
	Page
11.1 Valves de Protection Simple	37
11.2 Valves de Protection Multi Circuits	39
	Pagina
11.1 Valvole Protezione Serbatoi Monocircuito	37
11.2 Valvole Pretezione Serbatoi Multicircuito	39

Charging Valves (Overflow Valves)
Überströmventile

Valves de Protection Simple
Valvole Protezione Serbatoi Monocircuito

Legend		Legende	Légende	Legenda
A1	Supply	Eingang	Alimentation	Alimentazione
A2	Delivery	Ausgang	Sortie	Uscita
B	Opening pressure	Öffnungsdruck	Pression Ouverture	Pressione di apertura
B ₁	Adjustable	Verstellbar	Ajustable	Regolabile
C	Closing pressure	Schließdruck	Pression Fermeture	Pressione di chiusura
D	Backflow	Rückströmung	Retour	Ritorno
D ₁	With backflow	Mit Rückströmung	Avec retour	Con ritorno totale
D ₂	Limited backflow	Begrenzte Rückströmung	Retour limité	Con ritorno limitato
D ₃	Without backflow	Ohne Rückströmung	Sans retour	Senza ritorno



Part Number	Type Number	Fig.	A		B	C	D
			1	2			
0481063037000	-	1	M22x1,5	M22x1,5	10,4		D ₁
101275	-		1/4" NPTF	1/4" NPTF	-	4,8	D ₃
1111518000	-		1/8" NPT	Ø7,884	2,5		
228078	-		1/4" NPTF	1/4" NPTF		4,1	
277147DK	-	2	1/4" NPTF	1/4" NPTF		4,4	
277148DK	-	2	1/4" NPTF	1/4" NPTF		5,9	D ₂
277227DK	-	2	1/4" NPTF	1/4" NPTF		5,1	
277971DK	-	2	1/4" NPTF	1/4" NPTF		5,5	
288323	-		1/4" NPTF	1/4" NPTF		4,9	
KW4081/1	-	3	3/8" NPTF	1/2"NPTF	6,2		D ₂
VPC4A	-	4	M22x1,5	M22x1,5	7,4		D ₃
K000613	DR4150	5	M22x1,5	M22x1,5	B ₁	-	D ₁
K000615	DR4151	5	M22x1,5	M22x1,5	4,5	3,6	D ₁
K000616	DR4153	5	M22x1,5	M22x1,5	5,5	4,6	D ₁
K000618	DR4155	5	M22x1,5	M22x1,5	6,0	5,0	D ₁
K000619	DR4156	5	M22x1,5	M22x1,5	6,5	5,5	D ₁

11 (11.1)

Charging Valves (Overflow Valves) Überströmventile

Valves de Protection Simple Valvole Protezione Serbatoi Monocircuito

Part Number	Type Number	Fig.	A		B	C	D
			1	2			
K000622	DR4159	5	M22x1,5	M22x1,5	10,0	8,5	D ₁
K040214	DR4160	5	M22x1,5	M22x1,5	B ₁	–	D ₁
K000624	DR4250	5	M22x1,5	M22x1,5	B ₁	–	D ₂
K000626	DR4252	5	M22x1,5	M22x1,5	8,5	7,2	D ₂
K000627	DR4253	5	M22x1,5	M22x1,5	4,5	3,6	D ₂
K000630	DR4256	5	M22x1,5	M22x1,5	6,0	5,0	D ₂
K000632	DR4258	5	M22x1,5	M22x1,5	7,6	6,8	D ₂
K000634	DR4260	5	M22x1,5	M22x1,5	6,2	5,5	D ₂
K014658	DR4263	5	M22x1,5	M22x1,5	3,5	3,2	D ₂
K028608	DR4265	5	M22x1,5	M22x1,5	6,9	6,2	D ₂
K040215	DR4266	5	M22x1,5	M22x1,5	B ₁	–	D ₂
K000636	DR4370	5	M22x1,5	M22x1,5	B ₁	–	D ₃
K000638	DR4372	5	M22x1,5	M22x1,5	4,0	3,2	D ₃
K000639	DR4373	5	M22x1,5	M22x1,5	4,5	3,6	D ₃
K000641	DR4375	5	M22x1,5	M22x1,5	5,1	4,6	D ₃
K000642	DR4376	5	M22x1,5	M22x1,5	5,1	4,2	D ₃
K000643	DR4377	5	M22x1,5	M22x1,5	5,5	4,6	D ₃
K000644	DR4378	5	M22x1,5	M22x1,5	6,0	5,0	D ₃
K000645	DR4379	5	M22x1,5	M22x1,5	6,2	5,2	D ₃
K000647	DR4381	5	M22x1,5	M22x1,5	7,0	6,0	D ₃
K000649	DR4383	5	ISO228 G3/8	ISO228 G3/8	6,2	5,2	D ₃
K000651	DR4385	5	M22x1,5	M22x1,5	6,5	5,5	D ₃
K040216	DR4395	5	M22x1,5	M22x1,5	B ₁	–	D ₃
K040218	DR4397	5	M22x1,5	M22x1,5	6,2	5,2	D ₃
SEB00684	DR4502	6	M16x1,5	M12x1,5	0,5		D ₁

Multi Circuit Protection Valves
Mehrkreissschutzventile

Valves de Protection Multi Circuits
Valvole Protezione Serbatoi Multiciruito

	Legend	Legende	Légende	Legenda
A1	Supply	Eingang	Alimentation	Alimentazione
A2	Delivery	Ausgang	Sortie	Uscita
C	Circuits	Kreis	Circuits	Circuiti
F	Feedback with no Bypass	Mit Rückströmung und ohne Bypass	Avec retour et sans Bypass	Con ritorno e senza Bypass
F/B	Feedback with Bypass	Mit Rückströmung und Bypass	Avec retour et Bypass	Con ritorno e Bypass
N	Non-feedback with no Bypass	Ohne Rückströmung und ohne Bypass	Sans retour et sans Bypass	Senza ritorno e senza Bypass
N/B	Non-feedback with Bypass	Ohne Rückströmung und mit Bypass	Sans retour et avec Bypass	Senza ritorno e con Bypass
1)	Flange	Flansch	Flasque	Flangia

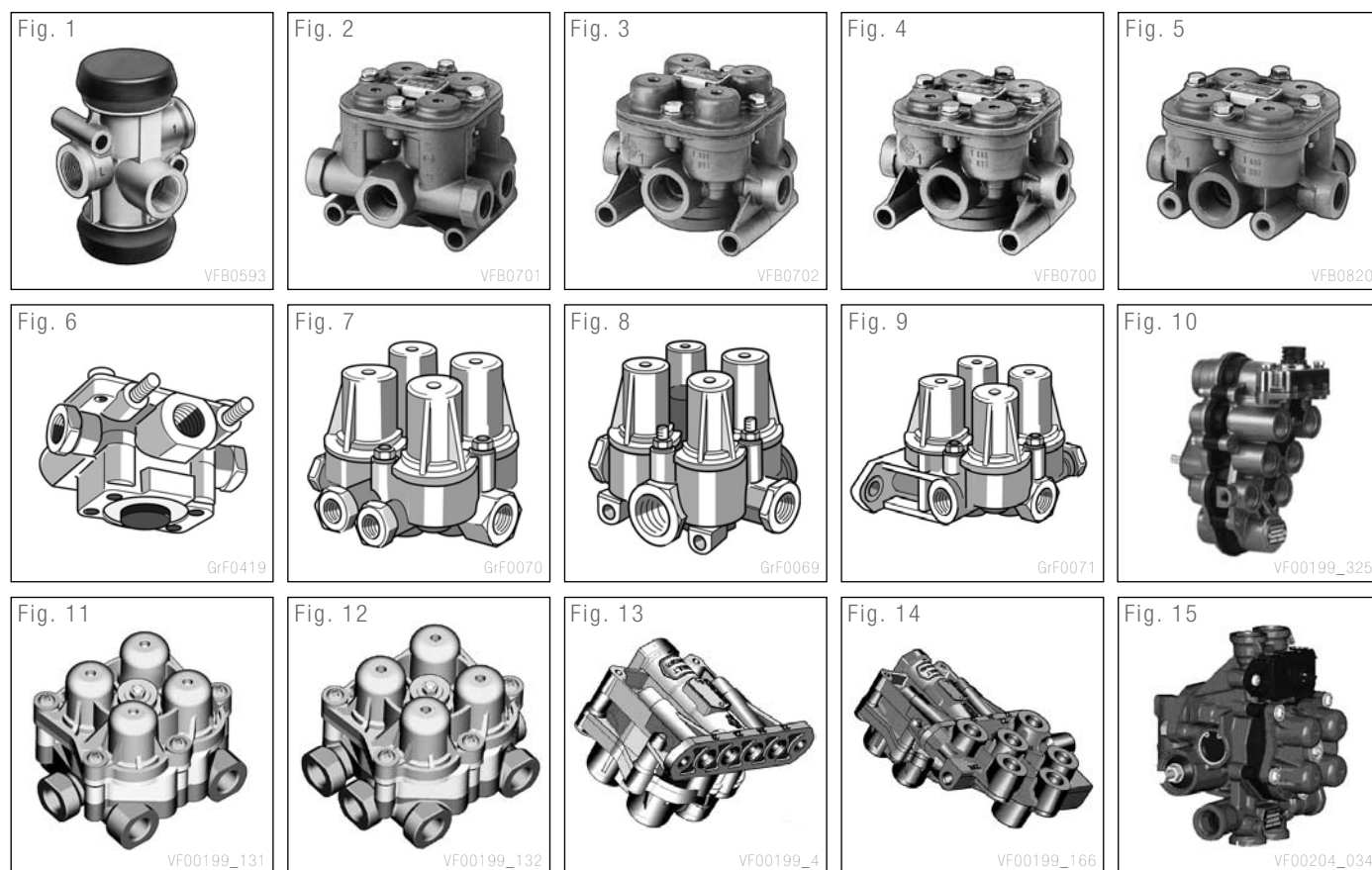

Part Number	Type Number	Fig.	A		C			
			1	2	21	22	23	24
0481027104000	–	1	M22x1,5	M22x1,5	N	N	–	–
0481062104000	–	2	M22x1,5	M16x1,5	N	N	N	N
0481062116170	–		M22x1,5	M22x1,5	N	N	N	N
0481062308000	–	3	M22x1,5	M16x1,5	N	N	N	N
0481062309000	–	4	M22x1,5	M16x1,5	N	N	N	N
0481062310000	–	3	M22x1,5	M16x1,5	N	N	N	N
0481062317000	–	4	M22x1,5	M16x1,5	N	N	N	N
0481062405000	–	5	M22x1,5	M16x1,5	N	N	N	N
0481062412000	–	5	M22x1,5	M16x1,5	N	N	N	N
0481062413000	–	5	M22x1,5	M16x1,5	N	N	N	N
VPS38AIY	–	6	1/2" NPTF	3/8" NPTF	N/B	N/B	F	–
VPS45HY	–	6	M22x1,5	M16x1,5	F	F	F	F
VPS45HYK	–	6	M22x1,5	M16x1,5	F	F	N	F
I85512	AE4162	7	M22x1,5	M16x1,5	F/B	F/B	N	N
I99810	AE4162	7	M22x1,5	M16x1,5	F/B	F/B	N	N
I77243	AE4170	8	M22x1,5	M16x1,5	F/B	F/B	F	F
I81272	AE4185	8	M22x1,5	M16x1,5	F/B	F/B	N	N
I89408000	AE4405	8	M22x1,5	M16x1,5	N/B	N/B	N	N
II15587000	AE4427	8	M22x1,5	M16x1,5	N	N	F	F
II15588000	AE4428	8	M22x1,5	M16x1,5	N	N	F	F
SEB01115	AE4440	9	M22x1,5	1)	F/B	F/B	F	F
SEB01273	AE4450	9	M22x1,5	1)	F/B	F/B	F	F
II31480000	AE4452	7	M22x1,5	M16x1,5	F/B	F/B	N	N
II35525	AE4459	8	M22x1,5	M16x1,5	F/B	F/B	N	N
K000055	AE4463	8	M22x1,5	M16x1,5	N/B	N/B	N	N
K011931	AE4502	10	1), M16x1,5	M16&M22x1,5	F/B	F/B	F	F
II38677F	AE4503	10	1), M16x1,5	M16&M22x1,5	F/B	F/B	F	F
II38797F	AE4506	10	M22x1,5 Voss	M22x1,5 Voss	F/B	F/B	F	F
II37680N50	AE4510	10	M22x1,5 Voss	M22x1,5	F/B	F/B	F	F
K011932N50	AE4516	10	1), M16x1,5	M16&M22x1,5	F/B	F/B	F	F
II37922	AE4525	10	M22x1,5	M22x1,5	F/B	F/B	F	F
II39010FN50	AE4526	10	1)	M22x1,5	F/B	F/B	F	F/B
II37463	AE4527	10	1), M16x1,5	M16&M22x1,5	F/B	F/B	N	N
II37464N50	AE4528	10	M22x1,5	M22x1,5	F/B	F/B	N	F/B
II38749F004	AE4529	10	1), M16x1,5	M22x1,5	F/B	F/B	N	F
K001041	AE4535	10	1)	M22x1,5	F/B	F/B	F	F
K025546	AE4535	10	1)	M22x1,5	F/B	F/B	F	F
K026822	AE4544	10	1), M16x1,5	M16&M22x1,5	F/B	F/B	F	F
II36011000	AE4603	11	M22x1,5	M16x1,5	F/B	F/B	N	N
II36012000	AE4604	12	M22x1,5	M16x1,5	F/B	F/B	F	F
II36650	AE4605	13	M22x1,5	1)	F/B	F/B	F	F
K011255	AE4605	13	M22x1,5	1)	F/B	F/B	F	F

Multi Circuit Protection Valves
Mehrkreis Schutzventile

Valves de Protection Multi Circuits
Valvole Protezione Serbatoi Multicircuito

Part Number	Type Number	Fig.	A		C			
			1	2	21	22	23	24
<i>II37461N50</i>	AE4608	11	1)	M16x1,5	F/B	F/B	N	N
<i>II37460</i>	AE4609	11	M16x1,5	M16x1,5	F/B	F/B	N	N
<i>II33856</i>	AE4611	11	M22x1,5	M16x1,5	F/B	F/B	F	F/B
<i>II38801F</i>	AE4612	11	M22x1,5	M16x1,5	F	F	N	N
<i>II38802F</i>	AE4613	11	M22x1,5	M16x1,5	F/B	F/B	F	F
<i>II36150</i>	AE4615	11	M22x1,5	M16x1,5	F/B	F/B	N	N
<i>II39140F</i>	AE4615	11	M22x1,5	M16x1,5	F/B	F/B	N	N
<i>K000500</i>	AE4623	11	M22x1,5 Voss	M22x1,5 Voss	F/B	F/B	N	N
<i>K000516</i>	AE4625	14	M22x1,5	1)	F/B	F/B	F	F
<i>K019904</i>	AE4641	11	M22x1,5	M16x1,5	F	F	F	F
<i>K019905</i>	AE4642	11	M22x1,5	M16x1,5	F	F	F	F
<i>K019906</i>	AE4643	11	M22x1,5	M16x1,5	F	F	F	F
<i>K019907</i>	AE4644	11	M22x1,5	M16x1,5	F	F	N	N
<i>K019908</i>	AE4645	11	M22x1,5	M16x1,5	F	F	N	N
<i>K019909</i>	AE4646	11	M22x1,5	M16x1,5	F	F	F	F
<i>K019911</i>	AE4648	11	M22x1,5	M16x1,5	F	F	F	F
<i>K002435N50</i>	AE4800	15	1)	M22x1,5 Voss	F/B	F/B	F	F

	Legend	Legende	Légende	Legenda
A1	Supply	Eingang	Alimentation	Alimentazione
A2	Delivery	Ausgang	Sortie	Uscita
A4	Control	Steuerung	Pilotage	Comando
B	Limited delivery pressure	Ausgangsdruck begrenzt	Pression d'autolimitation	Pressione di autolimitazione
C	Safety valve pressure	Öffnungsdruck Sicherheitsventil	Tarage de la valve de sécurité	Pressione della valvola di sicurezza
D	Adjustable from 1 to 8 bar	Einstellbar von 1 bis 8 bar	Réglable de 1 à 8 bar	Regolabile da 1 a 8 bar

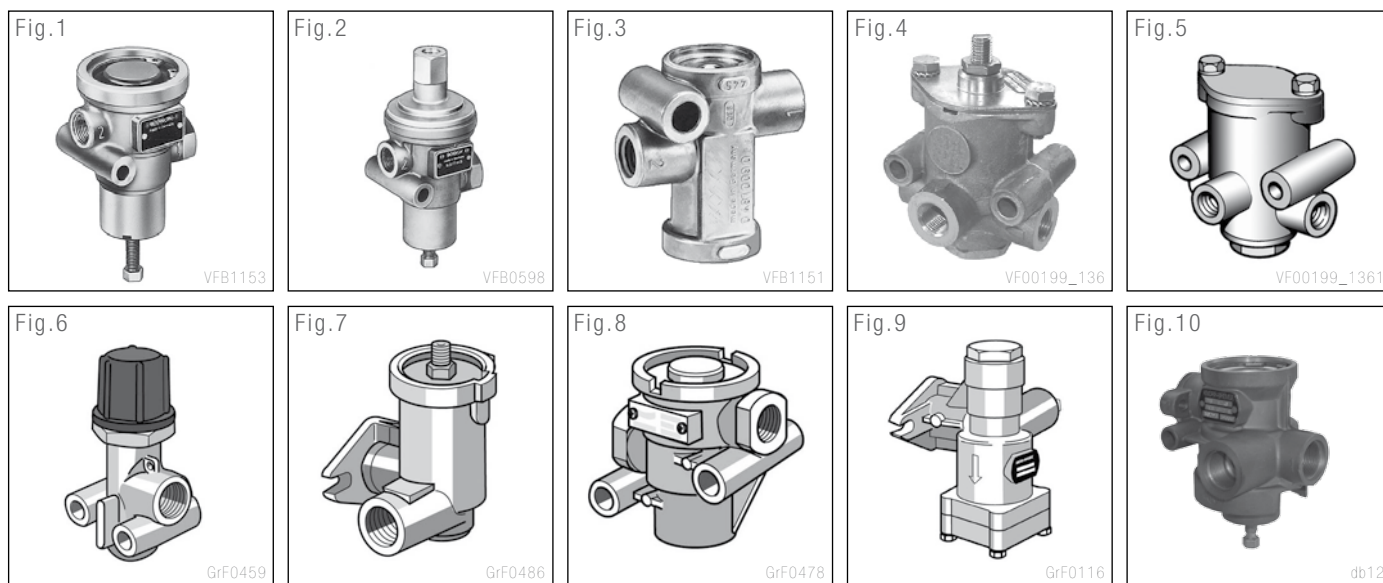

Part Number	Type Number	Fig.	A			B [bar]	C [bar]	D
			1	2	4			
0481009014000	–	1	M16x1,5	M16x1,5	–	3,5		
0481009017000	–	1	M16x1,5	M16x1,5	–	5,9		
0481009018000	–	1	M16x1,5	M16x1,5	–	7,3		
0481009020000	–	2	M16x1,5	M16x1,5	M12x1,5	9,5 / 7,3	10,5	
0481009021000	–	1	M16x1,5	M16x1,5	–	9,5	10,5	
0481009022000	–	1	M16x1,5	M16x1,5	–	7,3	10,5	
0481009023000	–	1	M22x1,5	M22x1,5	–	8,1		
0481009026000	–	1	M22x1,5	M22x1,5	–	5,9		
0481009029000	–	1	M16x1,5	M16x1,5	–	8,0		
0481009032000	–	1	M16x1,5	M16x1,5	–	3,2		
0481009034000	–	1	M16x1,5	M16x1,5	–	2,4		
0481009036000	–	3	M12x1,5	M12x1,5	–	4,2		
0481009039000	–	1	M16x1,5	M16x1,5	–	8,5		
0481009040000	–	1	M22x1,5	M22x1,5	–	7,5		
0481009047000	–	1	M22x1,5	M22x1,5	–	7,5		
0481009050000	–	1	M22x1,5	M22x1,5	–	7,4	10,0	
0481009055000	–	1	M22x1,5	M22x1,5	–	8,0		
0481009056000	–	1	M22x1,5	M22x1,5	–	10,0		

Part Number	Type Number	Fig.	A			B [bar]	C [bar]	D
			1	2	4			
0481009059000	–	1	M22x1,5	M22x1,5	–	7,0		
0481009061000	–	1	M16x1,5	M16x1,5	–	8,1	10,5	
0481009063000	–	1	M22x1,5	M22x1,5	–	7,4		
0481009065100	–	1	M22x1,5	M22x1,5	–	5,5		
0481009067000	–	1	M16x1,5	M16x1,5	–	5,6	7,5	
048100906905T	–	1	M22x1,5	M22x1,5	–	8,5		
048100907105T	–	1	M22x1,5	M22x1,5	–	2,0		
048100910222E	–	1	M16x1,5	M16x1,5	–	10,3		
1111340000	–	4	M16x1,5	M16x1,5	–	–		D
1111381000	–	5	M16x1,5	M16x1,5	–	7,5		
1111384000	–	5	M16x1,5	M16x1,5	–	8,5		
277144DK	–	6	1/4" NPTF	1/4" NPTF	–	5,5		
AC152AA	–	7	M22x1,5	M22x1,5	–	7,5		
AC152DA	–	7	M22x1,5	M22x1,5	–	7,3		
AC152LA	–	7	M22x1,5	M22x1,5	–	8,0		
AC155A	–	8	M16x1,5	M16x1,5	–	7,3		
AC155B	–	8	M16x1,5	M16x1,5	–	8,0		
AC155D	–	8	M16x1,5	M16x1,5	–	5,4		
AC155E	–	8	M16x1,5	M16x1,5	–	6,5		
AC155F	–	8	M16x1,5	M16x1,5	–	3,0		
AC156C	–	8	M16x1,5	M16x1,5	–	9,5	11,0	
AC156D	–	8	M16x1,5	M16x1,5	–	6,7	8,5	
AC157A	–	8	M22x1,5	M22x1,5	–	7,5	9,0	
AC157C	–	8	M22x1,5	M22x1,5	–	8,0	9,5	
AC157CA	–	8	M22x1,5	M22x1,5	–	8,0	9,5	
AC157E	–	8	M22x1,5	M22x1,5	–	5,5	7,0	
AC157G	–	8	M22x1,5	M22x1,5	–	4,2	5,7	
AC157L	–	8	M22x1,5	M22x1,5	–	3,6	5,1	
AC157M	–	8	M22x1,5	M22x1,5	–	7,0	8,5	
AC157P	–	8	M22x1,5	M22x1,5	–	10,0	11,5	
K011919	–	6	M12x1,5	M12x1,5	–	4,55		
K035707N00	–	16	M16x1,5	M16x1,5	–	8,4		
KX2045/11000	–	6	M12x1,5	M12x1,5	–	3,9		
KX2045/14000	–	6	M12x1,5	M12x1,5	–	2,3		
KX2045/16000	–	6	M12x1,5	M12x1,5	–	7,5		
KX2045/17000	–	6	M12x1,5	M12x1,5	–	2,0		
SEB01237	–		M12x1,5	M12x1,5	–	0,5		
K009286	AC155H	8	M16x1,5	M16x1,5	–	3,3		
K008340	AC155L	8	M16x1,5	M16x1,5	–	0,8		
K007410	AC155P	8	M16x1,5	M16x1,5	–	2,2		
K012528	AC155R	8	M16x1,5	M16x1,5	–	2,4		
K035389N00	AC156F	8	M16x1,5	M16x1,5	–	5,0		

Part Number	Type Number	Fig.	A			B [bar]	C [bar]	D
			1	2	4			
I22144	DB1104		M22x1,5	M22x1,5	–	–		D
I61241	DB1114	9	M22x1,5	M22x1,5	–	1,0		
I61707	DB1116	9	M22x1,5	M22x1,5	–	3,5		
I83747	DB1143	9	M22x1,5	M22x1,5	–	8,0		
I97953	DB1147	9	M22x1,5	M22x1,5	–	1,8		
K022185N00	DB1150	9	M22x1,5	M22x1,5	–	5,0		
I79644	DB1151	1	M16x1,5	M16x1,5	–	3,5		
I84927	DB1159	1	M16x1,5	M16x1,5	–	3,2		
SEB01183	DB1237	10	M22x1,5	M22x1,5	–	8,0		
SEB01224	DB1239	10	M22x1,5	M22x1,5	–	4,0		
SEB01258	DB1240	10	M22x1,5	M22x1,5	–	8,0		
I7178304	DMV18		M22x1,5	M12x1,5	–	0,4		
I7178305	DMV18		M22x1,5	M12x1,5	–	0,5		

	Page
13.1 Foot Brake Valves	46
13.2 Pedal Units	49
	Seite
13.1 Fussbremsventile	46
13.2 Pedaleinheiten	49
	Page
13.1 Robinets de Commande à Pied	46
13.2 Ensembles Pédalier	49
	Pagina
13.1 Distributori a Pedale	46
13.2 Pedaliere	49

13 (13.1)

Foot Brake Valves Fussbremsventile

Robinets de Commande à Pied Distributori a Pedale

Legend	Legende	Légende	Legenda
A1	Supply	Eingang	Alimentazione
A2	Delivery	Ausgang	Uscita
B	Front axle modulation ratio	Druckuntersetzung Vorderachskreis	Rapporto di riduzione assale anteriore
C	Limited delivery pressure	Ausgangsdruck begrenzt	Pressione di autolimitazione
D	With microswitch	Mit Mikroschalter	Con micro interruttore
E	With retarder control	Mit Retardersteuerung	Con controllo retarder
F	Integral silencer	Integrierter Schalldämpfer	Silenziatore integrato
G	With treadle	Mit Trittplatte	Con pedale
H	With delivery pressure transducers		Con sensori di pressione
1)	Hydraulic port M14x1,0	Hydraul. Anschluss M14x1,0	Raccordo idraulico M14x1,0
2)	Push-in	Steckanschluss	A innesto
3)	Flange	Flansch	Flangia

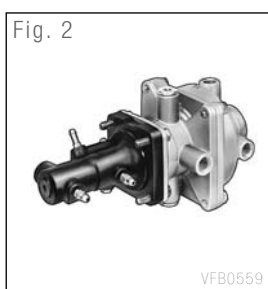

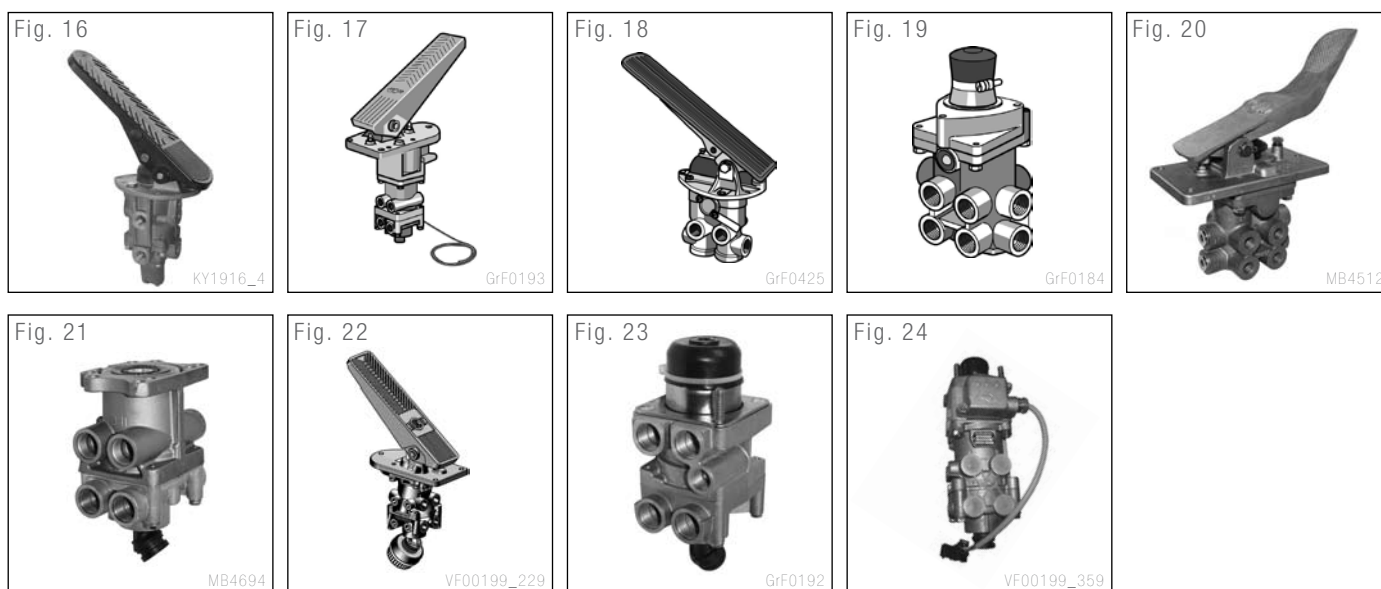

Part Number	Type Number	Fig.	A		B	C [bar]	Legend
			1	2			
0481064005000	-	1	M16x1,5	M16x1,5	-		
0481064007000	-	2	M16x1,5	M16x1,5	-		1)
0481064103000	-	3	M22x1,5	M22x1,5	-		
0481064106000	-	3	M22x1,5	M22x1,5	-		
0481064108000	-	1	M16x1,5	M16x1,5	-		
0481064113000	-	3	M22x1,5	M22x1,5	-		
0481064115000	-	4	M16x1,5 & M12x1,5	M16x1,5	-		
0481064117000	-		M16x1,5	M16x1,5	-		
0481064205000	-	5	M22x1,5	M22x1,5	1:1,5	8,0	
0481064603000	-	6	Ø12 mm ²⁾	Ø12 mm ²⁾	-		
1188768	-	7	M16x1,5	M16x1,5	-	9,0	
DX60A	-	8	³⁾ & M16x1,5	³⁾ & M16x1,5	-	-	D,F
DX61A	-	9	M22x1,5	M22x1,5	-	-	F
DX65B	-	8	M16x1,5	M16x1,5	-	7,6	D,F
DX65BA	-	8	M16x1,5	M16x1,5	-	7,6	D,F
DX65C	-	8	M16x1,5	M16x1,5	-	7,6	D,F
DX70C	-	10	M16x1,5 & M12x1,5	M16x1,5 & M12x1,5	-		
DX71BX	-	10	M16x1,5	M16x1,5	-		
DX71BY	-	10	M16x1,5	M16x1,5	-		
DX75BAY	-	11	M16x1,5	M16x1,5	-	7,6	D,F
DX75BX	-	12	M16x1,5	M16x1,5	-	7,6	D
DX80D	-	13	M16x1,5 & M12x1,5	M16x1,5 & M12x1,5	-		D,E,G
DX80E	-	13	M16x1,5	M16x1,5	-		D,E,G
DX81E	-		M16x1,5	M16x1,5	-	7,5	D

13 (13.1)

Foot Brake Valves
Fussbremsventile

Robinets de Commande à Pied
Distributori a Pedale

Part Number	Type Number	Fig.	A		B	C [bar]	Legend
			1	2			
DX95BX	–	12	M16x1,5	M16x1,5	1:1,5	7,6	D
DX95BY	–	14	M16x1,5	M16x1,5	1:1,5	7,6	D,F
DX95F	–	12	M16x1,5	M16x1,5	1:2,0	7,6	D
I874851	–		M14x1,5	M14x1,5	–		G
K011910	–	15	M16x1,5	M16x1,5	–	–	
KY1767/10	–	15	3/8" NPTF	3/8" NPTF	–	–	
KY1916/1	–	16	3/8" NPTF	3/8" NPTF	–	–	G
KY1916/4	–	16	M16x1,5	M16x1,5	–	–	G
K013005	DX60B	8	³⁾ & M16x1,5	³⁾ & M16x1,5	–	–	D,E,F
K006161	DX61D	17	M22x1,5 & M16x1,5	M22x1,5 & M16x1,5	–	10,5	D,F,G
K011883	DX61E	9	M22x1,5 & M16x1,5	M22x1,5 & M16x1,5	–	10,5	F,G
K011892	DX65D	8	³⁾	³⁾	–	7,6	D,F,H
K021896	DX65DH	8	³⁾	³⁾	–	8,3	D,F,H
K016510	DX80EX	12	M16x1,5 & M12x1,5	M16x1,5	–	–	
I72775	MB1200		M22x1,5	M22x1,5	–		G
II16361	MB1226	18	M22x1,5	M22x1,5	–	8	G
I82111	MB4436	19	M22x1,5	M22x1,5	–	8	
I55727	MB4512	20	M16x1,5	M16x1,5	–	8	G
SEB01098	MB4611	10	M16x1,5	M16x1,5	–	7,9	
I74907	MB4630	10	M16x1,5	M16x1,5	–	8,5	
II14119	MB4694	21	M22x1,5	M22x1,5	–	10,0	
II36045	MB4694	21	M22x1,5	M22x1,5	–	10,0	
I89742	MB4747	17	M16x1,5	M16x1,5	–	8,5	D,G
II36060	MB4763	22	M16x1,5	M16x1,5		8	
II36364	MB4813		M22x1,5 Voss	M22x1,5 Voss	1:2,0	10,5	F
II36302	MB4815		M22x1,5 Voss	M22x1,5 Voss	1:1,5	10,5	F
II36300	MB4820	23	M22x1,5 Voss	M22x1,5 Voss	1:2,0	10,5	
II36299	MB4821	23	M22x1,5 Voss	M22x1,5 Voss	1:1,5	10,5	
II36293	MB4833		M22x1,5 Voss	M22x1,5 Voss	1:2,7	10,5	
II36296	MB4836		M22x1,5 Voss	M22x1,5 Voss	1:2,7	10,5	F
II36174000	MB4849		M16x1,5 & M12x1,5	M16x1,5 & M12x1,5		8,5	
K000014	MB4850	24	M16x1,5	M16x1,5	–	8,5	D
K014516	MB4852	21	M16x1,5	M16x1,5	–	–	

	Legend	Legende	Légende	Legenda
A	Foot valve	Fussbremsventile	Robinet de commande à pied	Distributore a pedale
B	Mini / Midi-Servo	Mini / Midi-Servo	Mini / Midi-Servo	Mini / Midi-Servofrizione
C	Exhaust brake valve		Valve de frein sur echappement	Comando a Pedale
D	Drive	Lenkung	Conduite	Guida
D ₁	Left hand	Links angeordnet	Conduite à gauche	Guida a sinistra
D ₂	Right hand	Rechts angeordnet	Conduite à droite	Guida a destra

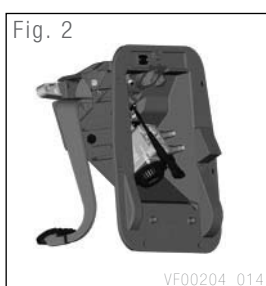

Part Number	Type Number	Fig.	A		B		C	D
			Part Number	Type Number	Part Number	Type Number		
PU1AYD	–	1	DX65C	–	K022028N00	SM1PLB	–	D ₂
PU1AYS	–	1	DX65C	–	K022028N00	SM1PLB	–	D ₁
PU3AYD	–	1	DX65C	–	K044874N00	SM2PA	–	D ₂
PU3AYS	–	1	DX65C	–	K044874N00	SM2PA	–	D ₁
PU4AYD	–	2	DX65C	–	–	–	–	D ₂
PU4AYS	–	2	DX65C	–	–	–	–	D ₁
PU5CD	–	2	K013005	DX60B	–	–	–	D ₂
PU5CS	–	2	K013005	DX60B	–	–	–	D ₁
PU5DD	–	2	K013005	DX60B	–	–	–	D ₂
PU5DS	–	2	K013005	DX60B	–	–	–	D ₁
K007464	PU1AXYD	1	K011982	DX65D	K015237N00	SM1PLD	–	D ₂
K007465	PU1AXYS	1	K011982	DX65D	K015237N00	SM1PLD	–	D ₁
K007466	PU3AXYD	1	K011982	DX65D	K044873N00	SM2PD	–	D ₂
K007468	PU3AXYS	1	K011982	DX65D	K044873N00	SM2PD	–	D ₁
K021920N00	PU3MYD	1	K011982	DX65D	K044873N00	SM2PD	–	D ₂
K021919N00	PU3MYS	1	K011982	DX65D	K044873N00	SM2PD	–	D ₁
K009935	PU4AX	2	DX65B	–	–	–	–	D ₂
K012908	PU4AXYD	2	K011982	DX65D	–	–	–	D ₂
K012907	PU4AXYS	2	K011982	DX65D	–	–	–	D ₁
K024648N00	PU4BMYD	2	K011982	DX65D	–	–	–	D ₂
K024645N00	PU4BMYS	2	K011982	DX65D	–	–	–	D ₁
K013147	PU4BXYD	2	K011982	DX65D	–	–	–	D ₂
K013146	PU4BXYS	2	K011982	DX65D	–	–	–	D ₁
K024500N00	PU4MYD	2	K011982	DX65D	–	–	–	D ₂
K022470N00	PU4MYS	2	K011982	DX65D	–	–	–	D ₁
K009363	PU6AX	1	K013005	DX60B	K044873N00	SM2PD	CP6A	D ₂

13 (13.2)

Pedal Units
Pedaleinheiten

Ensembles Pédalier
Pedaliere

Part Number	Type Number	Fig.	A		B		C	D
			Part Number	Type Number	Part Number	Type Number	Part Number	
K010558	PU7AX	1	DX65BA	–	K044873N00	SM2PD	CP6A	D ₁
K015137	PU7BX	1	DX65B	–	K044873N00	SM2PD	CP6A	D ₂
K015827	PU12DD	1	K013005	DX60B	K015310	MC1A	–	D ₂
K040266N00	PU12CXD	1	K013005	DX60B	K013984	MC1D	–	D ₂
K040265N00	PU12CXS	1	K013005	DX60B	K013984	MC1D	–	D ₁
K015827	PU12DD	1	K013005	DX60B	K015310	MC1A	–	D ₂
K015826	PU12DS	1	K013005	DX60B	K015310	MC1A	–	D ₁
K040268N00	PU12DXD	1	K013005	DX60B	K013984	MC1D	–	D ₂
K040267N00	PU12DXS	1	K013005	DX60B	K013984	MC1D	–	D ₁
K015507	PU16CD	1	K013005	DX60B	K015310	MC1A	CP6A	D ₂
K015506	PU16CS	1	K013005	DX60B	K015310	MC1A	CP6A	D ₁
K031478N00	PU16CXD	1	K013005	DX60B	K013984	MC1D	CP6A	D ₂
K031475N00	PU16CXS	1	K013005	DX60B	K013984	MC1D	CP6A	D ₁
K015509	PU16DD	1	K013005	DX60B	K015310	MC1A	CP6A	D ₂
K015508	PU16DS	1	K013005	DX60B	K015310	MC1A	CP6A	D ₁
K015511	PU16DXD	1	K013005	DX60B	K013984	MC1D	CP6A	D ₂
K015510	PU16DXS	1	K013005	DX60B	K013984	MC1D	CP6A	D ₁
K016807	PU17DXD	1	K013005	DX60B	K013984	MC1D	CP6A	D ₂
K016806	PU17DXS	1	K013005	DX60B	K013984	MC1D	CP6A	D ₁
K024480N00	PU18DS	1	K021896	DX65DH	K023831	MC3A	–	D ₁

	Legend	Legende	Légende	Legenda
A1	Supply	Eingang	Alimentation	Alimentazione
A2	Delivery	Ausgang	Sortie	Uscita
B	Mounting	Befestigung	Montage	Montaggio
B ₁	Hexagonal flange	Flansch Sechskant	Bride hexagonale	Flangia esagonale
B ₂	Square flange, top fixing	Flansch Rechteckig, Befestigung oben	Bride rectangulaire avec fixation sur le dessus	Flangia rettangolare, fissaggio superiore
B ₃	Square flange, bottom fixing	Flansch Rechteckig, Befestigung unten	Bride rectangulaire avec fixation sur le dessous	Flangia rettangolare, fissaggio inferiore
C	Port orientation	Anschlußlage	Orientation des orifices	Orientamento porte
C ₁	Down facing	Unten	Orifices sur face inférieure	Raccordi lato inferiore
C ₂	Side facing	Seitlich	Orifices sur face avant	Raccordi di lato
D	Operation	Betätigung	Orientation du Levier	Azionamento
D ₁	Right hand	Hebel rechts	Levier à Droite	Azionamento leva destra
D ₂	Left hand	Hebel Links	Levier à Gauche	Azionamento leva sinistra
E	Handle	Griffausführung	Type de Levier	Maniglia
E ₁	Round	Rundgriff	Levier Rond	Maniglia tonda
E ₂	Locking	Lösegriff	Anneau de desserrage	Maniglia a siringa
F	Number of upright circuits	Anzahl der direkt wirkenden Kreise	Nombre de circuit positif	Numero dei circuiti positivi
G	Number of inverse circuits	Anzahl der indirekt wirkenden Kreise	Nombre de circuit negatif	Numero dei circuiti negativi
H	Test position	Kontrollstellung	Position test	Posizione di Verifica
I	Microswitch	Mikroschalter	Interrupteur	Micro Interruttore
J	Emergency release feature	Notlöseeinrichtung	Dispositif d'urgence	Funzione di sicurezza
1)	Flange	mit Flansch	Flasque	Flangia

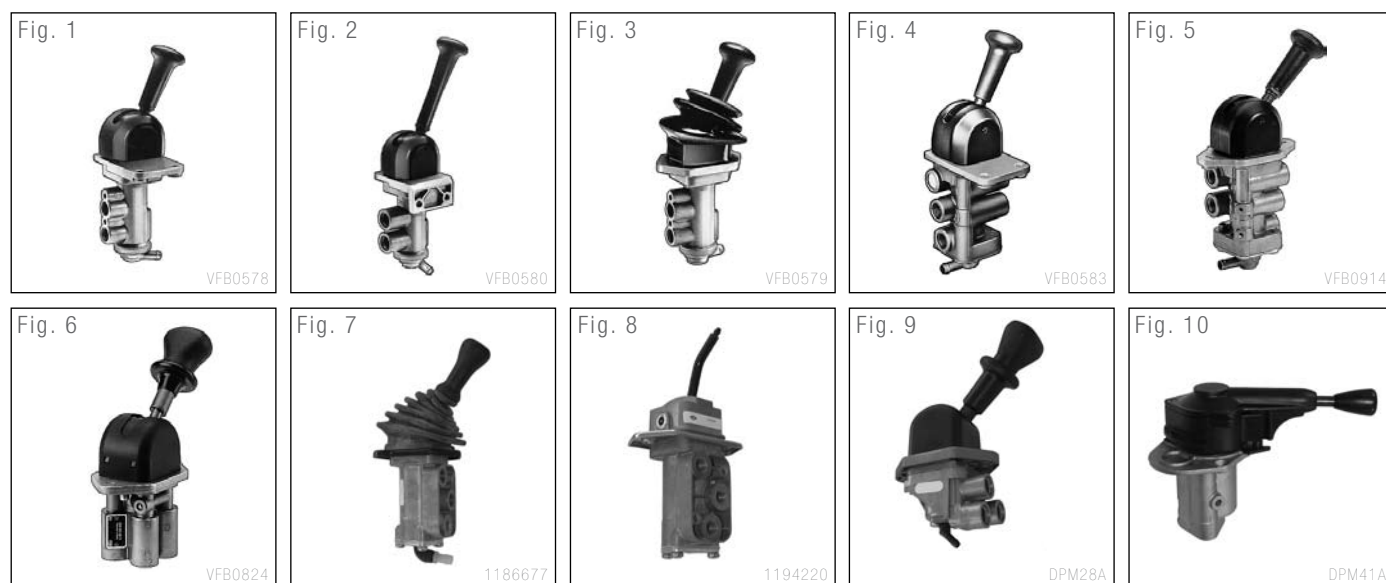

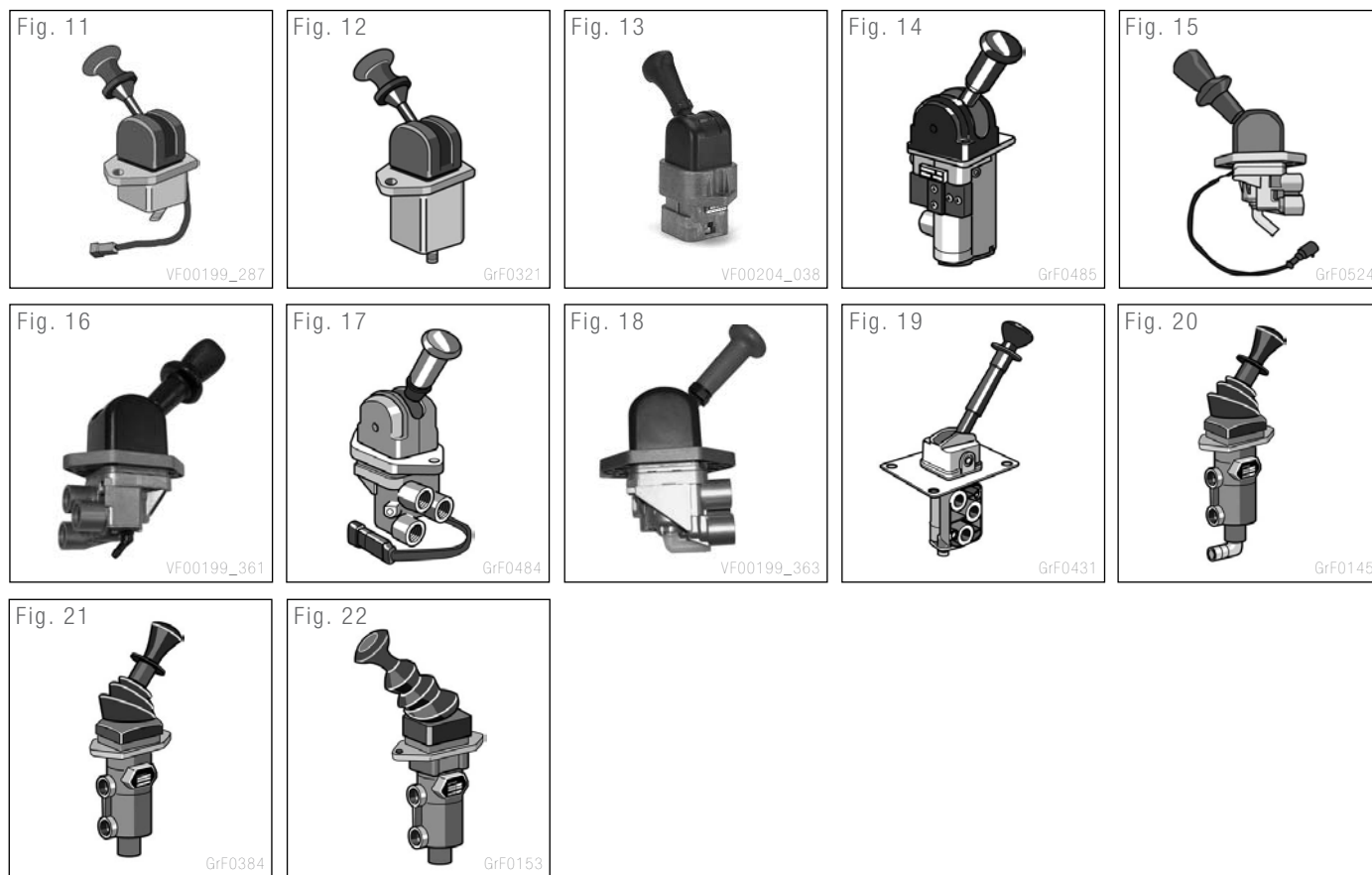

Part Number	Type Number	Fig.	A		B	C	D	E	F	G	H	I	J
			1	2									
0481016106000	-	1	M14x1,5	M14x1,5	B ₂	C ₂		E ₁					
0481016113000	-	2	M16x1,5	M16x1,5		C ₂		E ₁					
0481016117000	-	3	M16x1,5	M16x1,5	B ₁	C ₂		E ₁					
0481016201000	-	4	M14x1,5	M14x1,5	B ₂	C ₂		E ₁					
0481016209000	-	5	M14x1,5	M14x1,5	B ₁	C ₂		E ₁					
0481016603000	-	6	M16x1,5	M16x1,5	B ₁	C ₁		E ₂					
1043126000	-		M16x1,5	M16x1,5		C ₂			1				
1043135000	-		M16x1,5	M16x1,5		C ₂			1				
1043137000	-		M16x1,5	M16x1,5		C ₂			1				
1043138000	-		M16x1,5	M16x1,5		C ₂			1				
1186677	-	7	M14x1,5	M14x1,5		C ₂		E ₁			1		
1194220000	-	8	M12x1,5	M12x1,5	B ₁	C ₂					1		
1194221	-	8	M16x1,5	M16x1,5	B ₁	C ₂					1		
1194403	-	8	M16x1,5	M16x1,5	B ₁	C ₂					1		
1194404	-	8	M16x1,5	M16x1,5	B ₁	C ₂					1		
DPM28A	-	9	M16x1,5	M16x1,5	B ₁	C ₂	D ₁	E ₂	-	2	H		
DPM29A	-	9	M16x1,5	M16x1,5	B ₁	C ₂	D ₁	E ₂	-	1			
DPM40CA	-	10	M14x1,5	M14x1,5		C ₂	D ₂			2			

Part Number	Type Number	Fig.	A		B	C	D	E	F	G	H	I	J
			1	2									
DPM60EY	–	11	M16x1,5	M16x1,5	B ₁	C ₁		E ₂			H	I	
DPM61A	–	12	M16x1,5	M16x1,5	B ₁	C ₁	D ₂	E ₂	–	1			
DPM61EY	–	12	M16x1,5	M16x1,5	B ₁	C ₁		E ₂				I	
DPM62A	–	12	M16x1,5	M16x1,5	B ₁	C ₁	D ₂	E ₁		1			
DPM62BA	–		M16x1,5	M16x1,5	B ₁	C ₁	D ₂	E ₂	–	1			
DPM63AX	–	12	M16x1,5	M16x1,5	B ₁	C ₁	D ₂	E ₁		1		I	
DPM64A	–	13	1)	1)	B ₁	C ₁				2			
DPM65A	–	13	1)	1)	B ₁	C ₁				2	H		
DPM66A	–	13	1)	1)	B ₁	C ₁				2	H		
DPM67A	–	13	1)	1)	B ₁	C ₁				1			
DPM68A	–	13	1)	1)	B ₁	C ₁				1	H		
DPM80A	–	14	M14x1,5	M14x1,5	B ₃		D ₁				H	I	
DPM80AX	–	14	M14x1,5	M14x1,5	B ₃		D ₁				H		
DPM84AX	–	14	M14x1,5	M14x1,5	B ₁		D ₁						
DPM84CX	–	14	M14x1,5	M14x1,5	B ₁		D ₁					I	
DPM84CY	–	14	M14x1,5	M14x1,5	B ₁		D ₁					I	
DPM90B	–	15	M16x1,5 Voss	M16x1,5 Voss	B ₁	C ₂	D ₂	E ₂	–	2	H		
DPM90BK	–	15	M16x1,5 Voss	M16x1,5 Voss	B ₁	C ₂	D ₂	E ₂	–	2	H		
DPM90CK	–	15	M16x1,5 Voss	M16x1,5 Voss	B ₁	C ₂	D ₂	E ₂	–	2	H		
DPM90D	–	15	M16x1,5 Voss	M16x1,5 Voss	B ₁	C ₂	D ₂	E ₂	–	2	H		
DPM90DA	–	15	M16x1,5 Voss	M16x1,5 Voss	B ₁	C ₂	D ₂	E ₂	–	2	H		
DPM90EY	–	11	M16x1,5	M16x1,5	B ₁	C ₂	D ₂	E ₂		2	H	I	
DPM92A	–	15	M16x1,5	M16x1,5	B ₁	C ₂	D ₂	E ₂	–	1		I	
DPM92B	–	15	M16x1,5 Voss	M16x1,5 Voss	B ₁	C ₂	D ₂	E ₂	–	1			
DPM92BK	–	15	M16x1,5 Voss	M16x1,5 Voss	B ₁	C ₂	D ₂	E ₂	–	1			
DPM92D	–	15	M16x1,5 Voss	M16x1,5 Voss	B ₁	C ₂	D ₂	E ₂	–	1			
DPM93D	–	16	M16x1,5 Voss	M16x1,5 Voss	B ₁	C ₂		E ₂	–	2	H		
DPM94AAX	–	17	M16x1,5	M16x1,5	B ₁		D ₂	E ₁				I	
DPM94EY	–	17	M16x1,5	M16x1,5	B ₁	C ₂		E ₂				I	
DPM95AAX	–	17	M16x1,5	M16x1,5	B ₁	C ₂	D ₂	E ₁		2	H	I	
DPM95AK	–	9	M16x1,5	M16x1,5		C ₂				2	H		
DPM96DAX	–	17	M16x1,5	M16x1,5	B ₁	C ₂	D ₂	E ₁	–	1			
DPM96EY	–	17	M16x1,5	M16x1,5		C ₂	D ₁	E ₁	–	1			
DPM99A	–	18	M16x1,5	M16x1,5	B ₁	C ₂	D ₁	E ₁		2	H		
KY1467/23	–		1/8" NPTF	1/8" NPTF			D ₂	E ₂					
KY2357/1	–		1/4" PTF	1/4" PTF		C ₂		E ₂		1			
KY2498/1	–	19	1/4" PTF	1/4" PTF		C ₂		E ₂		1			
K028232N09	DPM60AJ	12	M16x1,5	M16x1,5	B ₁	C ₁		E ₂		2			
K007426	DPM60ND	12	M16x1,5	M16x1,5	B ₁	C ₁		E ₂		2	H		
K028234N09	DPM61AJ	12	M16x1,5	M16x1,5	B ₁	C ₁		E ₂		1			
K011306	DPM61BAY	12	M16x1,5	M16x1,5	B ₁	C ₁		E ₂					
K007429	DPM61ND	12	M16x1,5	M16x1,5	B ₁	C ₁							

Part Number	Type Number	Fig.	A		B	C	D	E	F	G	H	I	J
			1	2									
K018953N01	DPM64MP		1)	1)	B ₁	C ₁		E ₁		2			J
K018954N01	DPM65MP		1)	1)	B ₁	C ₁		E ₁		3	H		J
K018955N01	DPM66MP		1)	1)	B ₁	C ₁		E ₁		2	H		
K018797N01	DPM64SF	13	1)	1)	B ₁	C ₁		E ₁		2	H		
K018956N01	DPM67MP		1)	1)	B ₁	C ₁		E ₁		1			
K017049	DPM90DDX	9	M16x1,5	M16x1,5	B ₁	C ₂		E ₂					
K010078	DPM90DE	9	M16x1,5	M16x1,5	B ₁	C ₂		E ₂					
K010081	DPM90DEY	9	M16x1,5	M16x1,5	B ₁	C ₂		E ₂				I	
K017050	DPM90DSX	9	M16x1,5	M16x1,5	B ₁	C ₂		E ₂					
K010079	DPM92DE	15	M16x1,5	M16x1,5	B ₁	C ₂		E ₂		2			
K010080	DPM93DE	16	M16x1,5	M16x1,5	B ₁	C ₂		E ₂		2			
K025441N00	DPM93DEY	16	M16x1,5	M16x1,5	B ₁	C ₂		E ₂		2		I	
I82171N00	HB1143	20	M14x1,5	M14x1,5									
I85193	HB1242	21	M14x1,5	M14x1,5	B ₁			E ₂					
I92030	HB1258	20	M14x1,5	M14x1,5	B ₁			E ₂					
I98746	HB1267	20	M14x1,5	M14x1,5									
I82177	HB1350	22	M14x1,5	M14x1,5	B1			E ₂					

	Page
15.1 Load Sensing Valves – Mechanical Suspension	56
15.2 Load Sensing Valves – Air Suspension	58
	Seite
15.1 Bremskraftregler, mechanisch	56
15.2 Bremskraftregler, pneumatisch	58
	Page
15.1 Correcteurs de Freinage Suspension Mécanique	56
15.2 Correcteurs de Freinage Suspension Pneumatique	58
	Pagina
15.1 Correttori di Frenata Meccanici	56
15.2 Correttori di Frenata Pneumatici	58

15 (15.1)

Load Sensing Valves – Mechanical Suspension Bremskraftregler, mechanisch

Correcteurs de Freinage Suspension Mécanique Correttori di Frenata Meccanici

	Legend	Legende	Légende	Legenda
A1	Supply	Eingang	Alimentation	Alimentazione
A2	Delivery	Ausgang	Sortie	Uscita
A4	Control	Steuerung	Pilotage	Comando
B	Inshot pressure	Anlegedruck	Premier temps	Primo tempo
C	Normal control range of lever	Arbeitsbereich des Hebels	Débattement normal du levier	Range normale di controllo leva
D	Lever on left (L) or right (R)	Hebel links (L) oder rechts (R)	Levier à gauche (L) ou à droite (R)	Leva a sinistra (L) o a destra (R)
E	Supplied with lever	Einschliesslich Hebel	Livré avec levier	Fornito con leva
F	With emergency function	Mit Anhängersteuerventil	Avec fonction urgence	Con valvola d'emergenza
G	With relay function	Mit Relaisfunktion	Avec fonction relais	Con funzione relè (RV)
H	Integrated silencer	Integrierter Schalldämpfer	Silencieux intégré	Silenziatore integrato

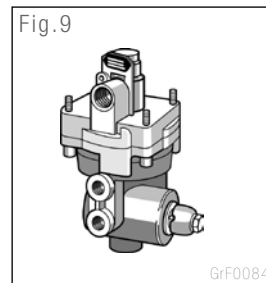
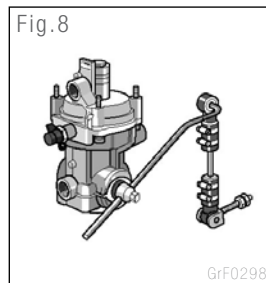
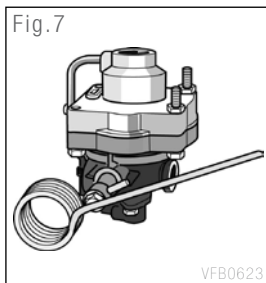
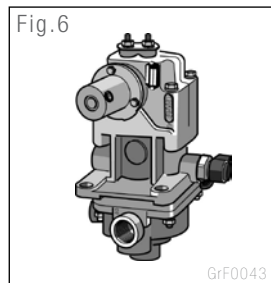
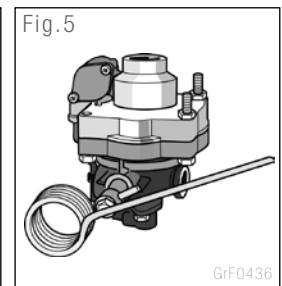
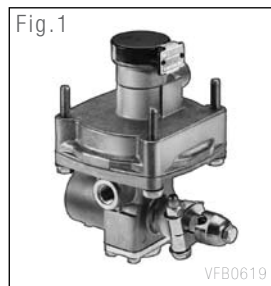

Part Number	Type Number	Fig.	A			B [bar]	C [°]	D	Legend
			1	2	4				
0481036206000	–	1	M16x1,5	M16x1,5	–	0,3	30	L	
0481065002000	–	2	M16x1,5	M16x1,5	–	0,45	30	L	E
0481065004000	–	3	M16x1,5	M16x1,5	–	0,45	30	L	E
0481097007000	–	4	M12x1,0	M12x1,0	–		30	R	E
1186938	–	5	M22x1,5	M22x1,5	–	0,5	68	R	E
1111995000	–	6	M22&M16x1,5	M22x1,5 (2) M16x1,5 (4)	M16x1,5	0,5	26	R	E,F,G
KY1038/3	–	7	M22x1,5	M22x1,5	–		30	R	E
KY1956/5	–		1/4" & 3/8" NPTF	1/4" & 3/8" NPTF	–		30	R	E
KY2184/1	–	5	M22x1,5	M22x1,5	–	0,5	68	L	E
KY2193/1	–	5	M22x1,5	M22x1,5	–	0,5	37	R	E
KY2193/2	–	5	M22x1,5	M22x1,5	–	0,5	37	L	E
KY2248/1	–	5	M22x1,5	M22x1,5	–	0,5	42	R	E
KY890/1	–	5	M22x1,5	M22x1,5	–		30	R	E
SEB00659	BR4352	8	M22&M16x1,5 Voss	M22x1,5 (2) M16x1,5 (4)	M16x1,5	0,4	20	R	E,F,G
II15372000	BR4441	9	M22x1,5	M16x1,5	M16x1,5	0,5	30	L	G
II18784	BR4455	9	M22x1,5	M16x1,5	M16x1,5	0,5	30	L	G
II18785	BR4456	9	M22x1,5 Voss	M22x1,5 Voss	M16x1,5 Voss	0,6	30	R	G
II18786	BR4457	9	M22x1,5 Voss	M22x1,5 Voss	M16x1,5 Voss	0,6	30	L	G
II36826	BR4465	9	M22x1,5 Voss	M22x1,5 Voss	M16x1,5 Voss	0,5	30	R	E,G,H
II36828	BR4467	9	M22x1,5 Voss	M22x1,5 Voss	M16x1,5 Voss	0,5	30	R	E,G,H
II36829	BR4468	9	M22x1,5 Voss	M22x1,5 Voss	M16x1,5 Voss	0,5	30	L	E,G,H

	Legend	Legende	Légende	Legenda
A1	Supply	Eingang	Alimentation	Alimentazione
A2	Delivery	Ausgang	Sortie	Uscita
A4	Control	Steuerung	Pilotage	Comando
A41	Air bag signal port(s)	Dimension Anschlüsse Luftfederbalg	Dimension orifice(s) de contrôle suspension	Dimensione raccordo/i comando sospensioni pneumatiche
B	Inshot pressure	Anlegedruck	Premier temps	Primo tempo
C	Static (S) or Dynamic (D)	Statisch (S) oder Dynamisch (D)	Statique (S) ou Dynamique (D)	Statico (S) o Dinamico (D)
E	With relay function	Mit Relaisfunktion	Avec fonction relais	Con funzione relè
F	With emergency function	Mit Anhängersteuerventil	Avec fonction urgence	Con valvola d'emergenza

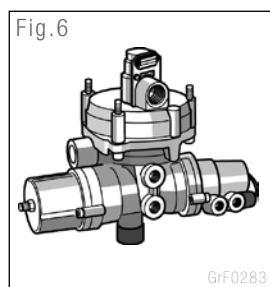
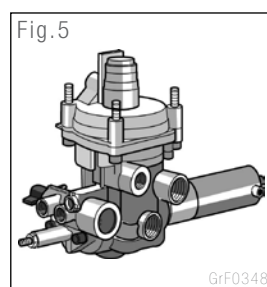
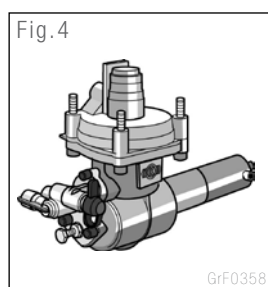
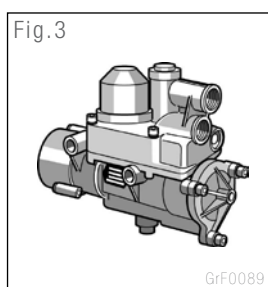
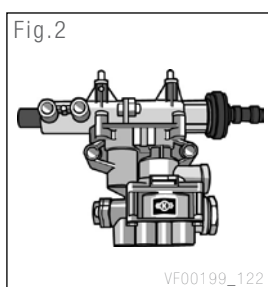

Part Number	Type Number	Fig.	A				B [bar]	C	E	F
			1	2	4	41				
0481065101000	–	1	M16x1,5	M16x1,5	M12x1,5	M12x1,5				
0481065103000	–	1	M16x1,5	M16x1,5	M12x1,5	–				
K022166N00	–	1	M16x1,5	M16x1,5	M12x1,5	–				
K023311N00	–	1	M16x1,5	M16x1,5	M12x1,5	–				
MP70A	–	2	M22x1,5	M22x1,5 (2)	M16x1,5	M12x1,5	0,5	S	E	
I94299	BR5407	3	M22x1,5	M16x1,5	–	M12x1,5	0,8			
II36836	BR5522	4	M22x1,5	M16x1,5	–	M12x1,5	0,4	S		
SEB01241	BR5524	5	M22x1,5 & M16x1,5	M22x1,5	M16x1,5	M12x1,5	0,4	D	E	F
II36818	BR5530	4	M16x1,5	M16x1,5	–	M12x1,5	0,6	S		
II14588	BR5615	6	M22x1,5 Voss	M22x1,5 Voss	M16x1,5 Voss	M16x1,5 Voss	0,5	D	E	
II37166	BR5657	6	M22x1,5	M22x1,5	M12x1,5	M12x1,5	0,4			
II37167	BR5658	6	M22x1,5 Voss	M22x1,5 Voss (2)	M16x1,5 Voss	M16x1,5 Voss	0,4		E	

Legend	Legende	Légende	Legenda
A1	Supply	Eingang	Alimentazione
A2	Delivery	Ausgang	Sortie
A4	Control	Steuerung	Pilotage
B	Exhaust flap	Entlüftungsmembrane	Soupape d'échappement
C	Integrated silencer	Integrierter Schalldämpfer	Avec silencieux intégré
D	Snap-on connector for silencer	Schnappanschluß für Schalldämpfer	Connecteur encliquetable pour silencieux
E	Predominance	Druckvoreilung	Prédominance
F	Only for spring brake circuits	Nur für Federspeicher-Kreis	Seulement pour frein à ressort
G	Inverse function	Relaisventil indirekt	Valve relais indirecte
¹⁾	With anti-compounding	Mit Additionsverhinderung	Avec valve anti-addition
			Con funzione anti-compound

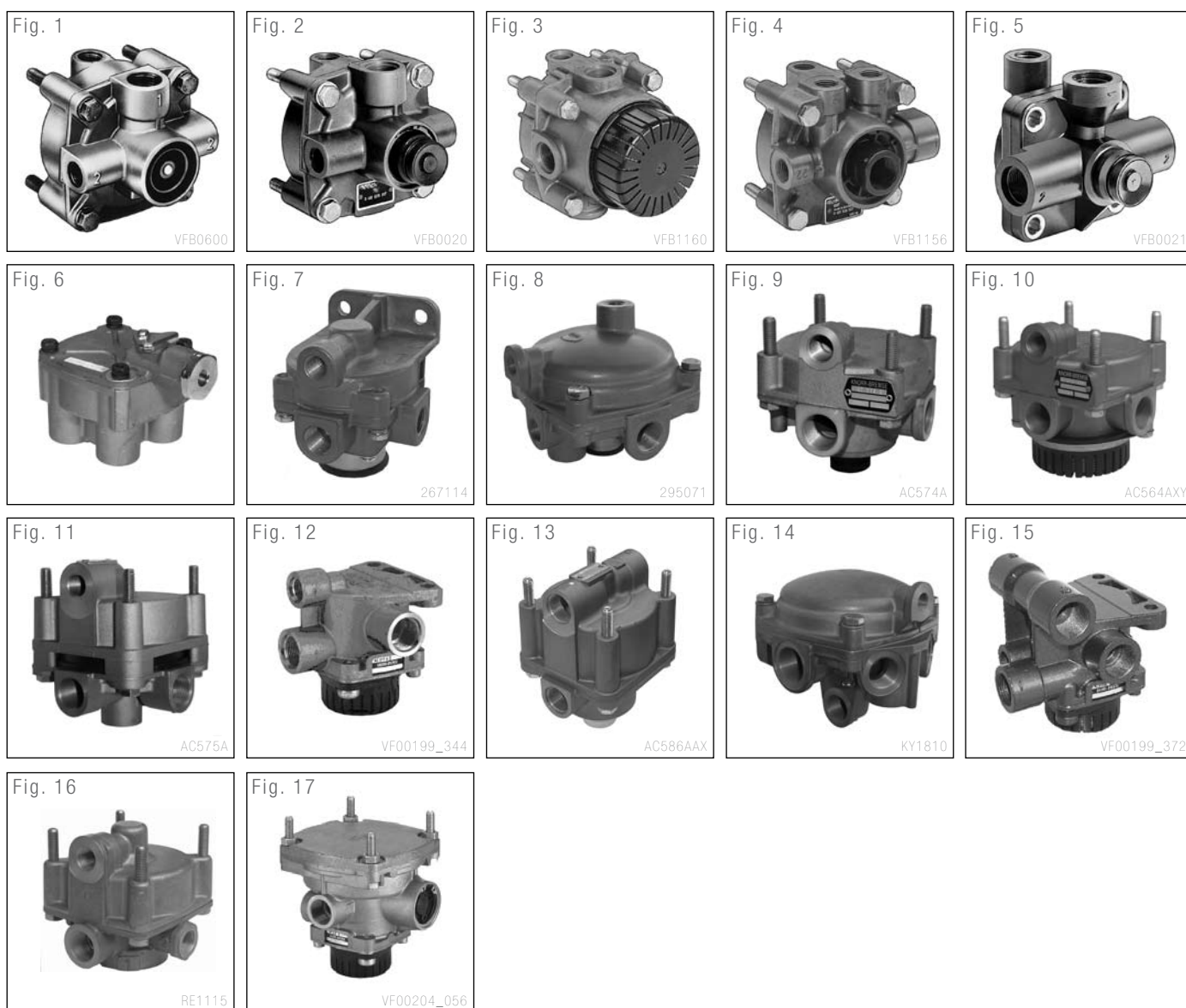

Part Number	Type Number	Fig.	A				E [bar]	F	G
			1	2	3	4			
0481026005000	–	1	M22x1,5	M16x1,5	B	M16x1,5			
0481026005000	–	1	M22x1,5	M16x1,5	B	M16x1,5			
0481026006000	–	1	M22x1,5	M16x1,5	B	M16x1,5			
0481026008000	–	1	M22x1,5	M22x1,5	B	M22x1,5			
0481026012000	–	1	M22x1,5	M16x1,5	B	M16x1,5			
0481026013000	–	1	M22x1,5	M16x1,5	B	M16x1,5			
0481026021000	–	2	M22x1,5	M22x1,5	B	M16x1,5			
0481026022000	–	2	M22x1,5	M22x1,5	B	M16x1,5			
0481026023000	–	3	M22x1,5 Voss	M22x1,5 Voss	B	M16x1,5 Voss			
0481026026000	–	3	M22x1,5	M22x1,5	C	M16x1,5			
0481026026000	–	3	M22x1,5	M22x1,5	C	M16x1,5			
0481026027000	–	4	M22x1,5	M16&M22X1,5	M22x1,5	M16x1,5			
04810260302E4	–	4	1/2" NPTF	1/2"&3/8" NPTF	B	1/4" NPTF			
04810260312E4	–	4	1/2" NPTF	1/2"&3/8" NPTF	B	1/4" NPTF			
0481026302000	–	5	M22x1,5	M16x1,5	D	M16x1,5			
0481026306000	–	5	M22x1,5	M22x1,5	B,D	M16x1,5			
0481026307000	–		M22x1,5	M22x1,5	C	M16x1,5			
0481026505	–		1/2" NPTF	1/2"&3/8" NPTF	B	1/4" NPTF			
0821302026234	–		M22x1,5	M22x1,5		M16x1,5			
103060	–	6	1/2" NPTF	1/2"&3/8" NPTF	B	1/4" NPTF			
267114	–	7	3/8" NPTF	3/8" NPTF	B	1/4" NPTF			
280375DK	–	8	1/2" NPTF	3/8" NPTF	B	1/4" NPTF			
295071	–	8	1/2" NPTF	3/8" NPTF	B	1/4" NPTF			
295199	–	8	M22x1,5	M16x1,5	B	M12x1,5			
295295	–	8	1/2" NPTF	3/8" NPTF	B	1/4" NPTF			
295528	–	8	M22x1,5	M22x1,5	B	M16x1,5			
AC574A	–	9	M22x1,5	M22x1,5	B	M16x1,5			
AC574AK	–	9	M22x1,5	M22x1,5	D	M16x1,5			
AC574AX	–	9	M22x1,5	M22x1,5	B	M16x1,5			
AC574AXY	–	9	M22x1,5	M22x1,5	C	M16x1,5			
AC574AY	–	9	M22x1,5	M22x1,5	C	M16x1,5			
AC574BYW	–	10	M22x1,5	M22x1,5	C	M16x1,5			
AC574CXY	–	9	M22x1,5	M22x1,5	C	M16x1,5			
AC574HXY	–	10	M22x1,5	M22x1,5	C	M16x1,5			
AC575A	–	11	M22x1,5	M22x1,5	B,M22X1,5	M16x1,5			
AC576AK	–	11	M22x1,5	M22x1,5	M22X1,5	M16x1,5			
AC577A	–	12	M22x1,5 Voss	M22x1,5 Voss	C	M16x1,5 Voss	F		
AC577AA	–	12	M22x1,5	M22x1,5	C	M16x1,5	F		
AC577B	–	12	M22x1,5	M22x1,5	C	M16x1,5	F		
AC586AAX	–	13	M22x1,5	M22x1,5	D	M22x1,5			
AC586AY	–		M22x1,5	M22x1,5	D	M22x1,5			
KY1810/1	–	14	M26x1,5	M22&M12x1,5		M12x1,5			

Part Number	Type Number	Fig.	A				E [bar]	F	G
			1	2	3	4			
<i>K008490</i>	AC574AA	9	M22x1,5	M22x1,5	C	M16x1,5			
<i>K008433</i>	AC579BK	15	M22x1,5	M22x1,5	C	M22x1,5 ¹⁾			
<i>I76792</i>	RE1110	16	M22x1,5	M22x1,5	B	M22x1,5			
<i>II16468</i>	RE1141	16	M22x1,5	M16x1,5	M22X1,5	M16x1,5			
<i>I63354</i>	RE2221	13	M22x1,5	M22x1,5	B	M22x1,5 ¹⁾	F		
<i>II38821F</i>	RE3311		M22x1,5 Voss	M22x1,5 Voss	D	M22x1,5 Voss		G	
<i>II39050F000</i>	RE3312		M22x1,5	M22x1,5	D	M22x1,5		G	
<i>K016654</i>	RP2B	17	M22x1,5	M22x1,5	C	M22x1,5	0,7		

Legend		Legende	Légende	Legenda
A1	Supply	Eingang	Alimentation	Alimentazione
A2	Delivery	Ausgang	Sortie	Uscita
A3	Exhaust	Entlüftung	Echappement	Scarico
B	By-pass	Bypass	Bypass	By-pass
C	Exhaust with connections	Entlüftung mit Anschlüssen	Echappement avec connecteurs	Scarico con connessioni
D	Exhaust flap	Entlüftungsmembrane	Soupape d'échappement	Scarico con membrana
E	With silencer fitted	Mit Schalldämpfer	Avec silencieux fileté	Provvisto di silenziatore

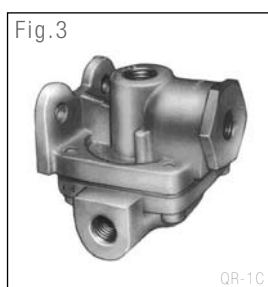

Part Number	Type Number	Fig.	A			Legend
			1	2	3	
107740	–	1	1/2" NPTF	3/8" NPTF	–	
1186892	–	1	M22x1,5	M16x1,5	M22x1,5	
1194339	–	2	M22x1,5	M16x1,5	M22x1,5	
229813N	–	1	3/8" NPTF	3/8" NPTF	–	
274996	–	1	3/8" NPTF	1/4" NPTF	3/8" NPTF	
274997	–	1	3/8" NPTF	3/8" NPTF	3/8" NPTF	
274999	–	1	1/2" NPTF	3/8" NPTF	3/8" NPTF	
289714	–	3	1/4" NPTF	3/8" NPTF	–	
KX1294/1	–	1	M22x1,5	M16x1,5	M16x1,5	
KX1294/2	–	1	M16x1,5	M16x1,5	M16x1,5	
KX1294/4	–	1	M16x1,5	M16x1,5	M16x1,5	
KX2000/1	–	1	M22x1,5	M22x1,5	M22x1,5	
KX2196/1	–	1	M22x1,5	M16x1,5	M16x1,5	
KX2552/3	–	1	M22x1,5	M16x1,5	M22x1,5	B
KY2590/4	–	4	M22x1,5	M16x1,5	C	
KY2590/5	–	4	M22x1,5	M16x1,5	C	
I74908	RE2113	1	M22x1,5	M22x1,5	D	
I82697000	RE2117	1	M22x1,5	M22x1,5	M22x1,5	
I92200	RE2118	1	M22x1,5	M22x1,5	D	
II36017	RE2131	1	M22x1,5	M22x1,5	E	

Pressure Proportioning Valves
Druckwandler

Réducteurs de Pression
Riduttori di Pressione Proporzionali

Legend	Legende	Légende	Legenda
A1 Supply	Eingang	Alimentation	Alimentazione
A2 Delivery	Ausgang	Sortie	Uscita
A4 Control	Steuerung	Pilotage	Comando
B Reduction ratio	Druckuntersetzung	Rapport de réduction	Rapporto di riduzione

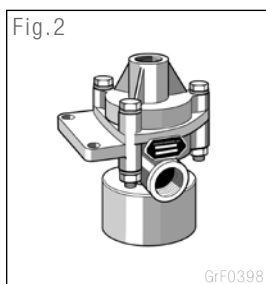
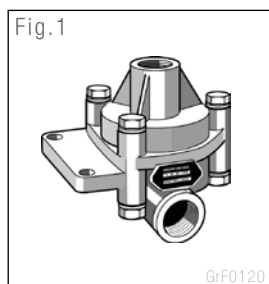

Part Number	Type Number	Fig.	A			B
			1	2	4	
1101687000	–		M16x1,5	M16x1,5	M16x1,5	2,0:1
288417N	–	1	3/8" NPTF	3/8" NPTF	–	
I86154	DB2115	1	M22x1,5	M22x1,5	–	1,5:1
K021266N00	DB2115	1	M22x1,5	M22x1,5	–	1,5:1
II36219	DB2116	1	M22x1,5	M22x1,5	–	1,15:1
K001043	DB2116	2	M22x1,5	M22x1,5	–	1,15:1
K001047	DB2116	2	M22x1,5	M22x1,5	–	1,15:1
I86156	DB2118	1	M22x1,5	M22x1,5	–	1,35:1
K001044	DB2122	2	M22x1,5	M22x1,5	–	1,25:1
K003165	DB2122	2	M22x1,5	M22x1,5	–	1,25:1
K020878N00	DB2122	2	M22x1,5	M22x1,5	–	1,25:1
I86159	DB2123	1	M22x1,5	M22x1,5	–	2,7:1
II36021	DB2142	2	M22x1,5	M22x1,5	–	1,35:1

Legend	Legende	Légende	Legenda
A1	Supply	Eingang	Alimentazione
A2	Delivery	Ausgang	Uscita
A4	Control	Steuerung	Comando
B	Predominance	Druckvoreilung	Predominanza
C	Integrated silencer	Integrierter Schalldämpfer	Con silenziatore integrato
D	Integral supply dump	Integriertes Abreissventil	Servodeviatore

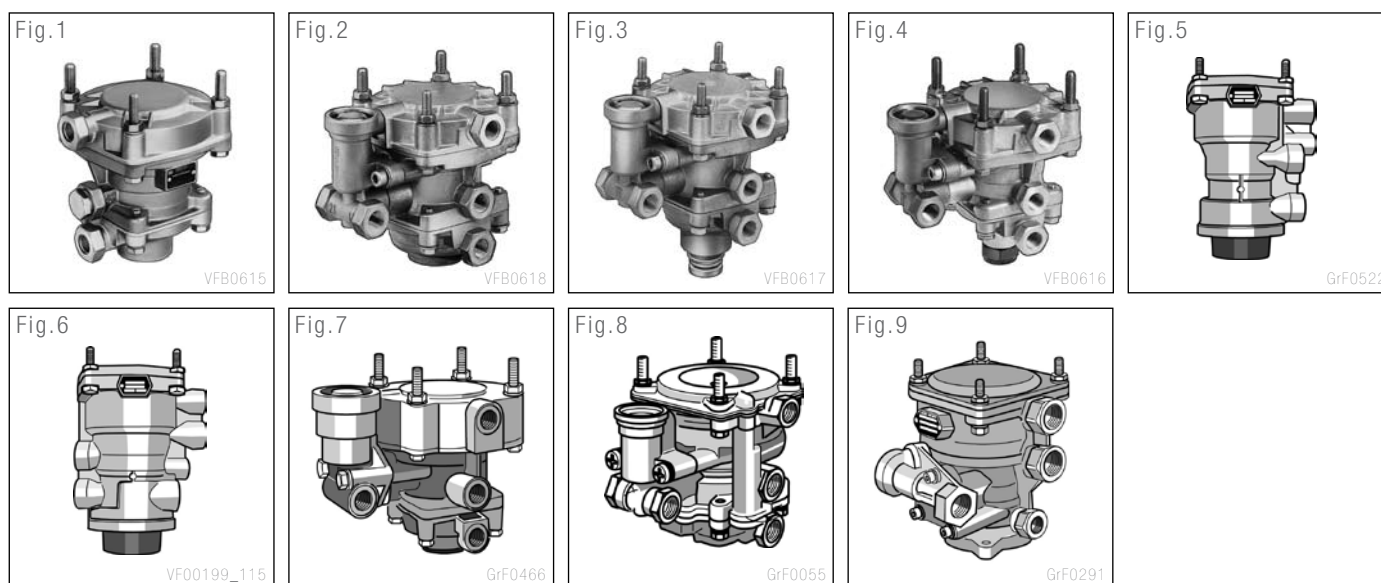

Part Number	Type Number	Fig.	A		B [bar]	Legend
			1 & 2	4		
0481061005000	-	1	M16x1,5	M16x1,5		
0481061020000	-	1	M16x1,5	M16x1,5	0,2 max.	
0481061214000	-	2	M16x1,5	M16x1,5		D
0481061219000	-	3	M16x1,5	M16x1,5	0,25 max.	D
0481061220000	-	2	M16x1,5	M16x1,5	0,2 max.	D
0481061226000	-	3	M16x1,5	M16x1,5	0,3 max.	D
0481061230000	-	2	M16x1,5	M16x1,5	0,8 max.	D
0481061231000	-	2	M16x1,5	M16x1,5	1,3 max.	D
0481061233000	-	4	M16x1,5	M16x1,5	0,2 max.	D
0481061248000	-	3	M16x1,5	M16x1,5	0,5 max.	D
AC596A	-	5	M22x1,5	M22&M16x1,5	0,15	C,D
AC596B	-	5	M22x1,5	M22&M16x1,5	0,6	C,D
AC597A	-	6	M16x1,5	M16x1,5	0,3	C,D
AC597B	-	6	M16x1,5	M16x1,5	0,2	C,D
AC597BA	-	6	M16x1,5	M16x1,5	0,2	C,D
AC597BZ	-	6	M16x1,5	M16x1,5	0,3	C,D
AC597C	-	6	M16x1,5	M16x1,5	0,5	C,D
AC597D	-	6	M16x1,5	M16x1,5	0	C,D

Trailer Control Valves
Anhängersteuerventile

Valves de Commande de Remorques
Valvole Comando Rimorchio

Part Number	Type Number	Fig.	A		B [bar]	Legend
			1 & 2	4		
AC598A	–	6	M22x1,5	M22x1,5	0	C,D
AC598B	–	6	M22x1,5	M22x1,5	0,4	C,D
AC598BX	–		M22x1,5	M22x1,5	0,4	C,D
AC598C	–	6	M22x1,5	M22x1,5	0,7	C,D
AC599A	–	6	M22x1,5	M22x1,5	0,2	C,D
KY2106/5	–	7	3/8" NPTF	3/8" NPTF	0,25	D
KY2111/7	–		3/8" NPTF	3/8" NPTF	0	
SEB00791	AB2793	8	M16x1,5	M16x1,5	0	D
II37151	AB2851	9	M22x1,5	M22&M16x1,5	0,7	D
SEB01333	AB2860	8	M16x1,5	M16x1,5	0	D
SEB01542	AB2863		M16x1,5	M16x1,5	0,2	C
K016685	AC597BJ	6	M16x1,5	M16x1,5	0,2	C,D

Legend	Legende	Légende	Legenda
A	Port sizes	Anschlussgewinde	Raccord
B	Colour	Farbe	Couleur
B ₁	Black	Schwarz	Noir
B ₂	Red	Rot	Rouge
B ₃	Yellow	Gelb	Jaune
C	Self sealing	Selbstdichtend	A clapet
D	With integrated Line Filter	Mit integriertem Rohrleitungsfilter	Avec filtre intégré
			Con filtro in linea integrato

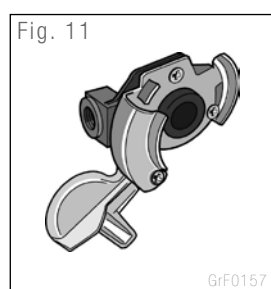
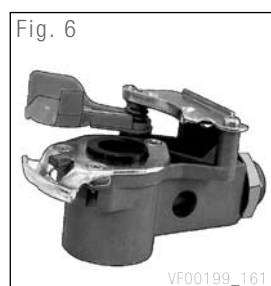
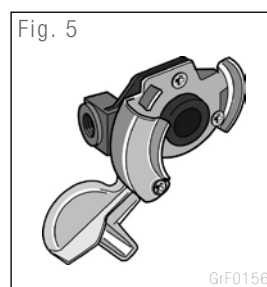
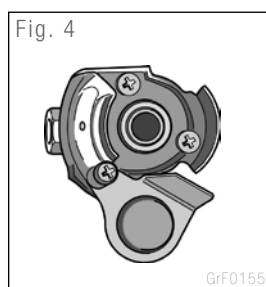

Part Number	Type Number	Fig.	A	B	C	D
0484103106000	–	1	2 x M16x1,5	B ₂		
0484150112000	–	2	M16x1,5	B ₃		
0484150119000	–	2	M16x1,5	B ₃		
0484150120000	–	2	M16x1,5	B ₂		
AC480B	–		M18X1,5	B ₃	C	
AC481B	–		M18X1,5	B ₂	C	
I25011A	–	3				
I59070	KU1303	4	M22x1,5	B ₁		
I59258	KU1304	4	M22x1,5	B ₃		
II33262	KU1304	4	M22x1,5	B ₃		

Part Number	Type Number	Fig.	A	B	C	D
<i>II33263</i>	KU1305	4	M22x1,5	B ₂		
<i>II17354</i>	KU1310	5	M16x1,5	B ₂		
<i>II17355</i>	KU1311	5	M16x1,5	B ₃		
<i>K000952</i>	KU1400	6	M16x1,5	B ₂		D
<i>K000953</i>	KU1401	7	M16x1,5	B ₂		D
<i>K000954</i>	KU1410	8	M16x1,5	B ₃		D
<i>K000955</i>	KU1411	9	M16x1,5	B ₃	C	D
<i>K000956</i>	KU1412	10	M24x1,5	B ₃		D
<i>K004229</i>	KU4124	11	M16x1,5	B ₂	C	
<i>K004231</i>	KU4124	11	M16x1,5 ISO6149	B ₂	C	
<i>K013662</i>	KU4124	11	M16x1,5	B ₂		
<i>K018111N00</i>	KU4124	11	M16x1,5	B ₂		
<i>K004152</i>	KU4128	11	M16x1,5	B ₃	C	
<i>K004230</i>	KU4128	11	M16x1,5 ISO6149	B ₃	C	
<i>K013661</i>	KU4128	11	M16x1,5	B ₃	C	
<i>K018110N00</i>	KU4128	11	M16x1,5	B ₃	C	

	Legend	Legende	Légende	Legenda
A1	Supply	Eingang	Alimentation	Alimentazione
A2	Delivery	Ausgang	Sortie	Uscita
A4	Control	Steuerung	Pilotage	Comando
B	Predominance	Druckvoreilung	Prédominance	Predominanza
C	With manoeuvring valve	Mit Löseventil	Avec valve de défreinage	Con manettino di sfrenatura

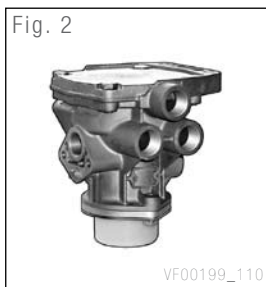
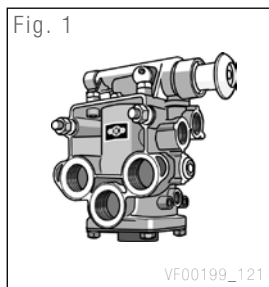

Part Number	Type Number	Fig.	A			B [bar]	C
			1	2	4		
AC560AA	–	1	M22x1,5	M22x1,5	M22x1,5	0,5	C
AC560BAK	–	1	M22x1,5	M30x1,5	M22x1,5	0,5	C
AS3050A	–	2	M22x1,5	M22x1,5 (3x)	M22x1,5		

Check Valves (Single and Double)
Rückschlag- und Wechselventile

Clapets Anti-Retour / Valves anti addition
Valvola di non ritorno (singola e doppia)

	Page
22.1 Single Check Valves	70
22.2 Double Check Valves	71
	Seite
22.1 Rückschlagventile	70
22.2 Wechselventile	71
	Page
22.1 Valves à Clapets Anti-Retour	70
22.2 Doubles Valves d'Arrêt	71
	Pagina
22.1 Valvole di Ritenuta	70
22.2 Valvole Doppie d'Arresto	71

22 (22.1)

Single Check Valves Rückschlagventile

Valves à Clapets Anti-Retour Valvole di Ritenuta

	Legend	Legende	Légende	Legenda
A1	Supply	Eingang	Alimentation	Alimentazione
A2	Delivery	Ausgang	Sortie	Uscita
1)	External thread	Aussengewinde	Filetage extérieur	Filetto esterno
2)	Internal thread	Innengewinde	Filetage interne	Filettatura interna

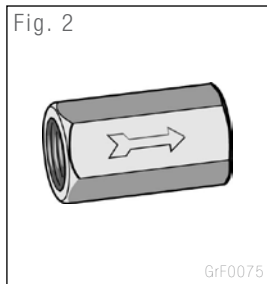
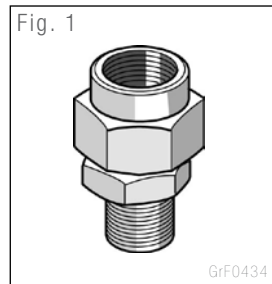

Part Number	Type Number	Fig.	A	
			1	2
1186831	–	1	M22x1,5 ¹⁾	M22x1,5 ²⁾
1194016	–	2	M22x1,5 ²⁾	M22x1,5 ²⁾
K019253	–	1	M22x1,5 ¹⁾	M22x1,5 ²⁾
KW2966/1	–	1	1/2" NPTF ²⁾	1/2" NPTF ¹⁾
KW3205/1	–	1	1/2" NPTF ²⁾	1/2" NPTF ¹⁾
KW4455/1	–	1	M22x1,5 ²⁾	M22x1,5 ¹⁾
KW4648/1	–	1	M22x1,5 ²⁾	M22x1,5 ¹⁾
KW5271/1	–	1	M22x1,5 ²⁾	M22x1,5 ¹⁾
I25351	AE5101	2	M22x1,5 ²⁾	M22x1,5 ²⁾
I75598	AE5115	2	M22x1,5 ²⁾	M22x1,5 ²⁾
K001349	AE5131	1	M22x1,5 ²⁾	M22x1,5 ¹⁾

Double Check Valves Wechselventile

Doubles Valves d'Arrêt Valvole Doppie d'Arresto

Legend		Legende		Légende		Legenda	
A1	Supply	Eingang		Alimentation		Alimentazione	
A2	Delivery	Ausgang		Sortie		Uscita	

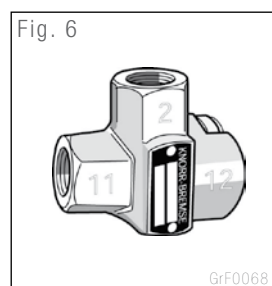
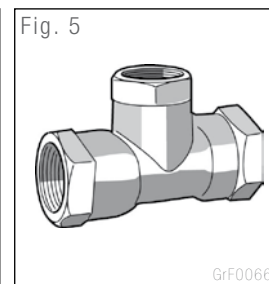
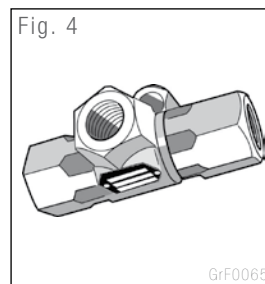
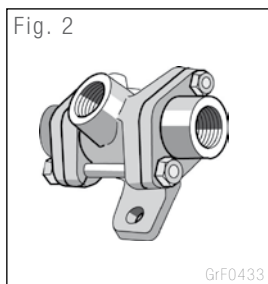
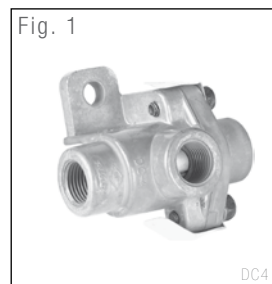

Part Number	Type Number	Fig.	A	
			1	2
283321	-	1	3/8" NPTF	3/8" NPTF
295358	-	2	M16x1,5	M16x1,5
295036N	-	2	3/8" NPTF	3/8" NPTF
1111419000	-	3	M16x1,5	M16x1,5
1111519000R	-	3	M16x1,5	M16x1,5
I37739	-		1/4" BSP	1/4" BSP
I15658	AE4102	4	1/4" NPTF	1/4" NPTF
I17154	AE4103	4	1/2" NPTF	1/2" NPTF
I40405	AE4105	5	M22x1,5	M22x1,5
I93219	AE4254	6	M16x1,5	M16x1,5

	Legend	Legende	Légende	Legenda
A1	Supply	Eingang	Alimentation	Alimentazione
A2	Delivery	Ausgang	Sortie	Uscita
B	Operating pressure	Betriebsdruck	Pression de fonctionnement	Pressione di esercizio



Part Number	Type Number	Fig.	A		B
			1	2	Max [bar]
0481015002000	–	1	M12x1,5	M12x1,5	10
0481015003100	–	1	M12x1,5	M12x1,5	10
I79002	–	2	1/4" BSP	1/4" BSP	10

Legend	Legende	Légende	Legenda
A1	Supply	Eingang	Alimentation
A2	Delivery	Ausgang	Sortie
A3	Exhaust	Entlüftung	Echappement
A4	Control	Steuerung	Pilotage
B	Operation	Betätigung	Fonctionnement
B ₁	Hand	Hand	Main
B ₂	Foot	Fuß	Pied
B ₃	Linkage	Gestänge	Tringlerie
B ₄	Hand/Elec. switch	Hand/Elekr. Schalter	Manuelle/Electrique
B ₅	Electrical	Elektrische	Electrique
B ₆	Air	Luft	Air
C	Number of ports/ Number of positions	Anzahl Anschlüsse/ Anzahl Stellungen	Numero des raccords/ Numero des positions

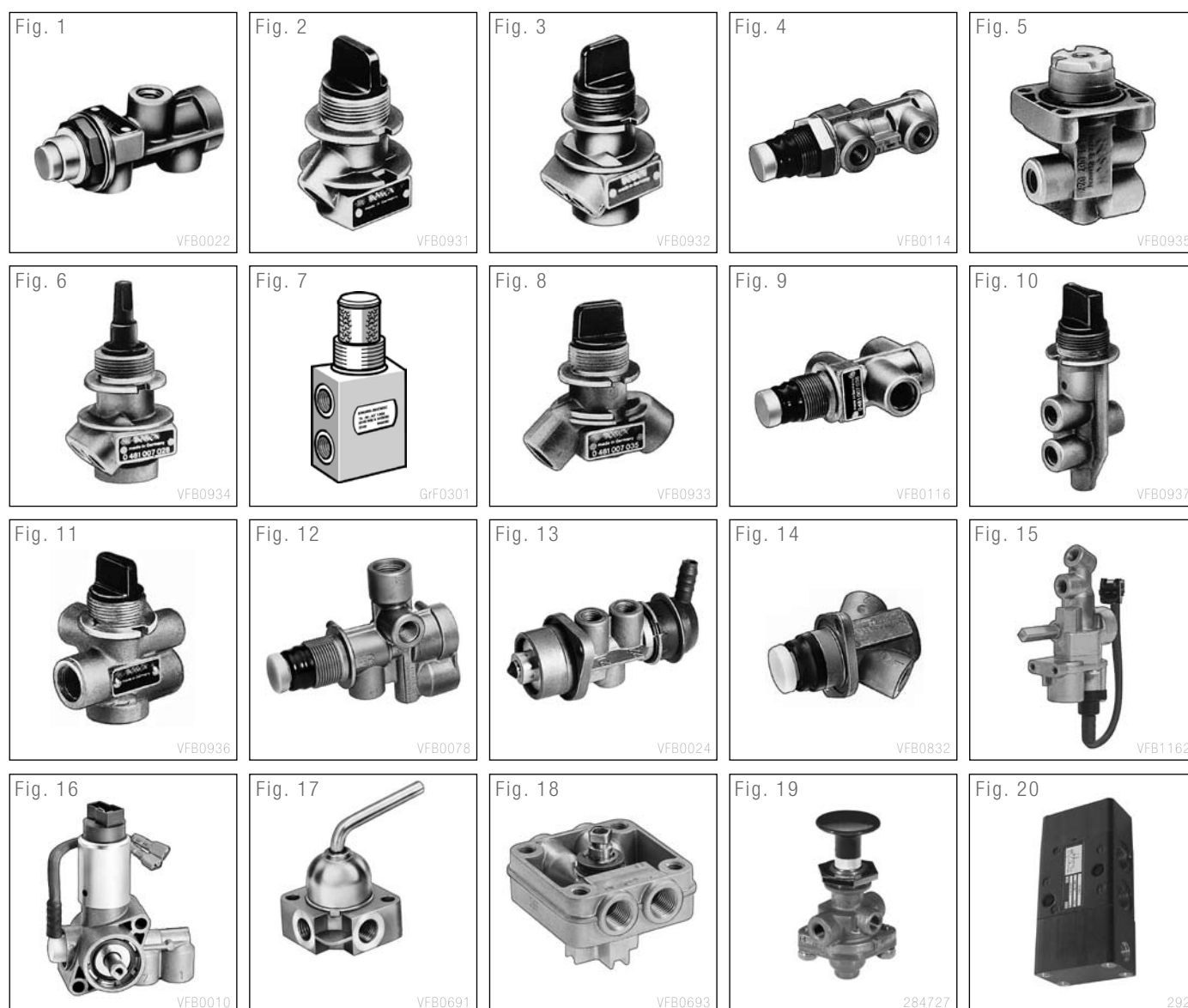

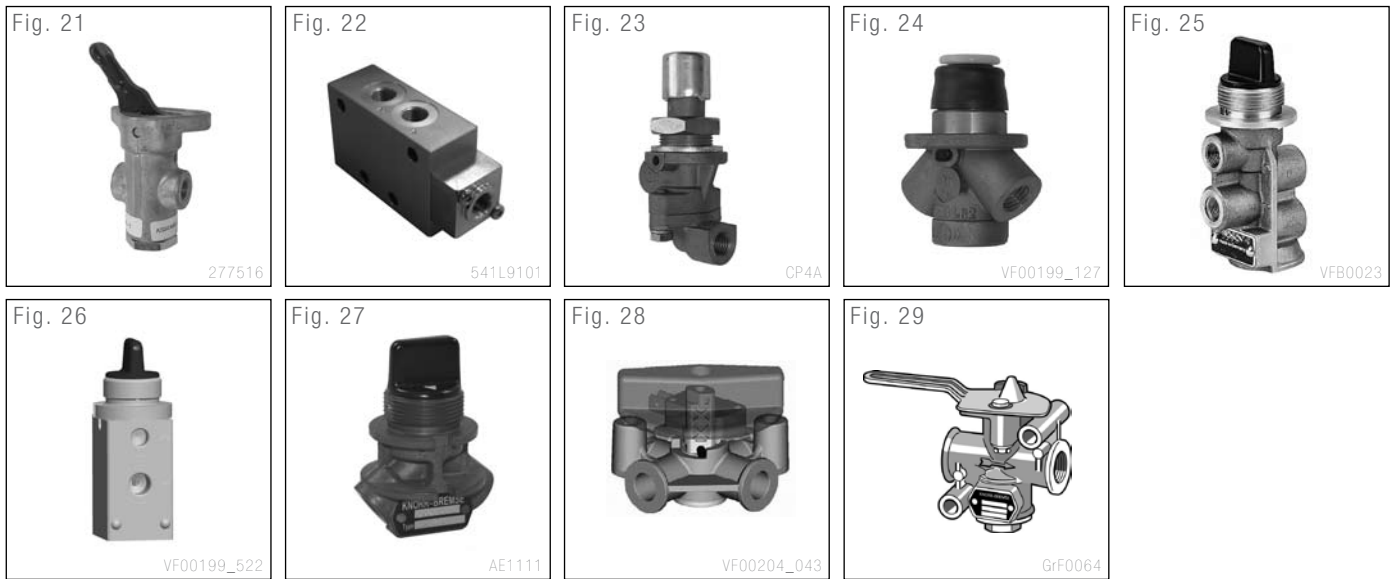

Part Number	Type Number	Fig.	A				B	C
			1	2	3	4		
0481007008100	–	1	M12x1,5	M12x1,5	–	–	B ₁	3/2
0481007012000	–	2	M10x1,0	M10x1,0	–	–	B ₁	3/2
0481007016000	–	3	M10x1,0	–	–	M10x1,0	B ₁	3/2
0481007022000	–	3	M10x1,0	M10x1,0	–	M10x1,0	B ₁	3/2
0481007023000	–	4	M12x1,5	M12x1,5	M12x1,5	–	B ₂	3/2
0481007027000	–	5	M10x1,0	M10x1,0	–	–	B ₁	3/2
0481007028000	–	6	M10x1,0	M10x1,0	–	–	B ₁	3/2
0481007029000	–	4	M12x1,5	M12x1,5	M12x1,5	–	B ₂	3/2
0481007031000	–	7	M12x1,5	M12x1,5	M12x1,5	–	B ₂	3/2
0481007035000	–	8	M16x1,5	M16x1,5	–	–	B ₁	3/2
0481007036000	–	9	M16x1,5	M16x1,5	M16x1,5	–	B ₂	3/2
0481007039000	–	10	M10x1,0	M10x1,0	–	–	B ₁	4/3
0481007043000	–	8	M16x1,5	M16x1,5	M10x1,0	–	B ₁	3/2
0481007046000	–	11	M16x1,5	M16x1,5	–	M16x1,5	B ₁	4/2
0481007047000	–	12	M16x1,5	M16&M12x1,5	M12x1,5	–	B ₂	3/2
0481007049000	–	13	M12x1,5	M12x1,5	–	–	B ₃	4/2
0481007057000	–	14	M12x1,5	M12x1,5	–	–	B ₂	3/2
0481007060000	–	15	M10x1,0	M10x1,0	–	–	B ₄	3/2
0481007501100	–	16	M12x1,5	M12x1,5	–	–	B ₄	3/3
0481007503000	–	16	M12x1,5	M12x1,5	–	–	B ₄	3/3
0484351005000	–	17	M12x1,5	M12x1,5	M12x1,5	–	B ₁	4/4
0484351012000	–	18	M10x1,0	M10x1,0	M10x1,0	–	B ₁	4/4
048435101305T	–	17	M12x1,5	M12x1,5	M12x1,5	M12x1,5	B ₁	4/4
0491051001170	–		Ø8,0	Ø8,0	Ø8,0	–	B ₅	3/2
104263	–	19	1/8" NPTF	1/8" NPTF	1/8" NPTF	–	B ₁	3/2
1194130	–	20	M14x1,5	M14x1,5	M14x1,5	M10x1,0	B ₆	3/2

Part Number	Type Number	Fig.	A				B	C
			1	2	3	4		
1111414000	–		M10x1,0	M10x1,0	Ø7,0	–	B ₁	3/2
1111430000	–		M10x1,0	M10x1,0	M6x1,0	–	B ₁	
1111437000	–		M10x1,0	M10x1,0	M6x1,0	–	B ₁	3/2
277516	–	21	1/8" NPTF	1/8" NPTF	–	–	B ₁	2/2
284727	–	19	1/8" NPTF	1/8" NPTF	1/8" NPTF	–	B ₁	3/2
541L9101	–	22	M10x1,0	M10x1,0	M10x1,0	M10x1,0	B ₆	3/2
CP4A	–	23	M12x1,5	M12x1,5	–	–	B ₂	2/2
CP4C	–	23	M12x1,5	M12x1,5	–	–	B ₂	2/2
CP6A	–	24	M12x1,5	M12x1,5	–	–	B ₂	2/2
CP6B	–	24	M12x1,5	M12x1,5	–	–	B ₂	2/2
CP6C	–	24	M12x1,5	M12x1,5	–	–	B ₂	2/2
CP6D	–	24	M12x1,5	M12x1,5	–	–	B ₂	2/2
CP6E	–	24	M12x1,5	M12x1,5	M12x1,5	–	B ₂	2/2
K005500	–	25	M10x1,0	M10x1,0	M10x1,0	–	B ₁	4/2
K037833N00	–	26	M12x1,5	M12x1,5	M10x1,0	–	B ₁	4/2
I66920	AE1111	27	M10x1,0	M10x1,0	–	–	B ₁	3/2
I73682	AE1114	27	M10x1,0	–	–	–		3/2
II30527	AE1136	27	M10x1,0	M10x1,0	–	–		3/2
K005161N00	AE1139	28	M12x1,5 x 2	M12x1,5 x 2	–	–	B ₁	4/2
I99961	AE2109	29	M22x1,5	M22x1,5	–	–	B ₁	2/2
II33261	AE2110	29	M22x1,5	M22x1,5	–	–	B ₁	2/2
I30064	WHV-9		M14x1,5	M14x1,5	M14x1,5	–		

		Page
25.1	Park / Shunt Valves	77
25.2	Manoeuvring Valves	78
		Seite
25.1	Kombilöseventile	77
25.2	Löseventile	78
		Page
25.1	Valves de Desserrage / Stationnement	77
25.2	Valves de Desserrage	78
		Pagina
25.1	Valvole di Sfrenatura	77
25.2	Rubinetti di Sfrenatura	78

	Legend	Legende	Légende	Legenda
A1	Supply	Eingang	Alimentation	Alimentazione
A2	Delivery	Ausgang	Sortie	Uscita
B	Push-in (Raufoss)	pneumatischer Steckanschluss (Raufoss)	Raccord rapide (Raufoss)	A innesto (Raufoss)
C	Emergency function	Notfunktion	Fonction urgence	Funzione di emergenza
D	Includes non-return valve	Einschließlich Sperrventil	Valve anti-retour intégrée	Valvola di non ritorno integrata
E	Pinned red button	Roter Knopf stiftgesichert	Bouton rouge avec épingle	Bottone rosso con spina
F	Integral charging valve	Integriertes Überströmventil	Valve de Barrage intégrée	Valvola Pressione Controllata integrata
G	Integrated front axle release valve	Integriertes Löseventil für die Vorderachse	Valve de desserrage essieu avant intégrée	Valvola integrata sblocco 1° asse rimorchio
H	With instruction plate	Mit Bedienschild	Avec plaque technique	Con targhetta
I	Instruction plate part number	Teilenummer des Bedienschilds	Référence de plaque technique	Codice targhetta

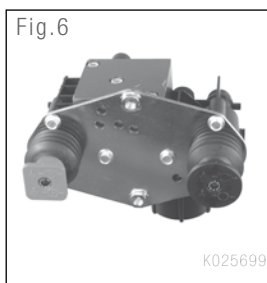
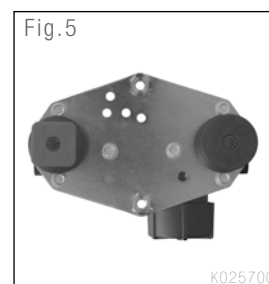
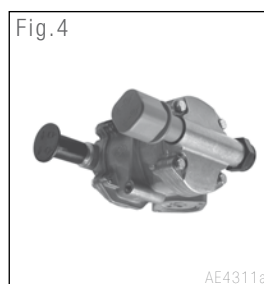
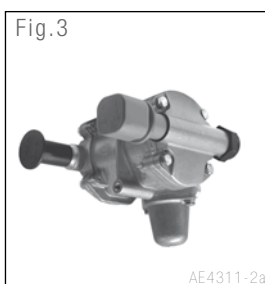
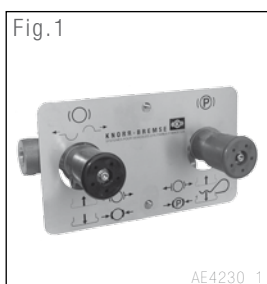

Part Number	Type Number	Fig.	A		C	D	E	F	G	H	I
			1	2							
II36128	AE4230	1	M16x1,5	M16x1,5						H	
II36129	AE4247	2	M16x1,5	M16x1,5		D	E			H	
II36131	AE4247	2	M16x1,5	M16x1,5		D	E			H	
K015380N00	AE4311	3	M16x1,5	M22x1,5	C	D	E	F			Z006845
K015849N00	AE4311	4	M16x1,5	M22x1,5	C	D	E				Z006845
K020123N00	AE4311	3	B	B	C	D	E	F			Z006845
K025700N00	AE4370	5	B	B				F		-	-
K025699N00	AE4371	6	B	B				F	G	-	-

	Legend	Legende	Légende	Legenda
A1	Supply	Eingang	Alimentation	Alimentazione
A2	Delivery	Ausgang	Sortie	Uscita
A ₃	Flange	Flansch	Flasque	Flangia

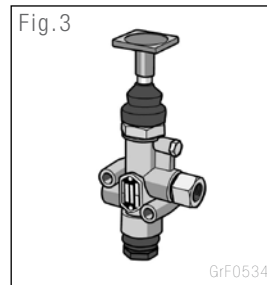
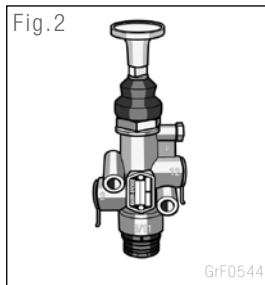

Part Number	Type Number	Fig.	A	
			1	2
AC286A	-		M22x1,5	M16x1,5
II36133	AE4232	1	M22x1,5	A ₃
II36134	AE4233	1	M16x1,5	A ₃
II19803	AE4261	2	M16x1,5	M16x1,5
II19802	AE4262	3	M16x1,5	M16x1,5
II36055	AE4264	3	M16x1,5	M16x1,5
II36061	AE4265	2	M16x1,5	M16x1,5

	Page
26.1 ABS Electronic Control Units (ECUs)	80
26.2 ABS Modulator Valves	83
26.3 Wheel Speed Sensors	84
	Seite
26.1 ABS-Elektronische Steuergeräte	80
26.2 ABS-Drucksteuerventile	83
26.3 Drehzahlsensoren	84
	Page
26.1 ABS – Unité de Commande Electronique	80
26.2 Valves Modulatrices ABS	83
26.3 Capteurs de Vitesse	84
	Pagina
26.1 Unità di Controllo Elettroniche ABS (ECU)	80
26.2 Modulatori ABS	83
26.3 Sensori di Velocità	84

Legend	Legende	Légende	Legenda
A Product family	Produktfamilie	Famille de produit	Famiglia di prodotti
B Voltage	Spannung	Tension	Tensione
C Configuration	Konfiguration	Configuration	Configurazione
D Plug type	Stecker Typ	Prise type	Tipo di presa
E Application	Anwendung	Application	Applicazione



ABS Electronic Control Units (ECUs)
ABS-Elektronische Steuergeräte

ABS - Unité de Commande Electronique
Unità di Controllo Elettroniche ABS (ECU)

Part Number	Type Number	Fig.	A	B [V]	C	D	E
0265150315181	–	1	Gamma 2E		ABS/ASR 4S/4M	35 pin	
0265150328000	–	2	I8		ABS/ASR 4S/4M	35 pin	
0486104021100	–	3	CN12	24	ABS/ASR 4S/4M	Modular	
0486104028100	–	4	CI12	24	ABS/ASR	Modular	
04861040302E4	–	5	U16	24	ABS/ASR 6S/6M		
0486104032170	–	6	SKN	24		Modular	
0486104033181	–	4	CI12	24	ABS/ASR 4S/4M	Modular	
0486104034100	–	4	CI12	24	ABS/ASR 4S/4M	Modular	
0486104039100	–	4	EU12	24	ABS/ASR 6S/6M	Modular	
0486104045100	–	3	EU12	24	ABS/ASR 4S/4M	Modular	Truck
0486104051100	–	7	CN12	24	ABS 4S/4M	Modular	
0486104056000	–	8	U16	12	ABS 4S/4M		
0486104063170	–	6	LKN	24	ABS 4S/4M	Modular	
0486104064170	–	6	ABS 2x	24	ABS 4S/4M	Modular	
0486104104100	–	4	ABS 2x	24	ABS 4S/4M	Modular	
0486104106000	–	9	ABS 2x	24	ABS 4S/4M	Modular	
0486104109100	–	4	ABS 2x	24	ABS 4S/4M	Modular	
0486104110100	–	4	ABS 2x	24	ABS 4S/3M	Modular	
0486104115100	–	10	ABS 2x	24	ABS 4S/4M	Modular	
0486104118100	–		LKN	24	ABS 4S/4M	Modular	
0486104120170	–	6	ABS 2x	24	ABS 4S/3M	Modular	
0486104122170	–	6	ABS 2x	24	ABS 4S/3M	Modular	
0486107002100	–	11	ABS 6	24	ABS 4S/3M	Modular	Truck
0486107007100	–	11	ABS 6	24	ABS 4S/4M	Modular	Truck/Bus
0486107008N01	–	12	ABS 6 Standard	24	ABS 4S/3M	Modular	
0486107009N01	–	12	ABS 6 Standard	24	ABS 4S/4M	Modular	
0486107011100	–	13	ABS 6 Standard	12	ABS 4S/4M	Modular	Truck
0486107012N00	–	11	ABS 6 Standard	24	ABS 4S/4M	Modular	Truck
0486107103100	–	9	ABS 6 Premium	24	ABS/ASR 4S/4M	Modular	
0486107105100	–	9	ABS 6 Premium	24	ABS/ASR 4S/4M	Modular	Truck/Bus
0486107106170	–	9	ABS 6 Premium	24	ABS/ASR 4S/4M	Modular	Bus
0486107107170	–	9	ABS 6 Premium	24	ABS/ASR 6S/6M	Modular	Bus
0486107108100	–	9	ABS 6 Premium	24	ABS/ASR 6S/6M	Modular	Bus
0486107111N00	–	9	ABS 6 Premium	24	ABS/ASR 6S/6M	Modular	Truck/Bus
0486107112N01	–	14	ABS 6 Premium	24	ABS 4S/4M	Modular	
04861071162E4	–	5	ABS 6 Premium	24	ABS/ASR 6S/6M		
04861071172E4	–	15	ABS 6 Premium	12	ABS/ASR 6S/6M	Modular	
0486107202N09	–	16	ABS 6 Advanced	24	ABS/ASR 6S/6M	Modular	
0486107302N00	–	11	ABS 6 Standard	24	ABS 4S/4M	Modular	
0486107311N01	–	14	ABS 6 Standard	24	ABS 4S/4M	Modular	
0486107313N01	–	14	ABS 6 Standard	24	ABS 4S/4M	Modular	
0486107502N00	–	15	ABS 6 Premium	24	ABS/ASR 6S/6M	Modular	

26 (26.1)

ABS Electronic Control Units (ECUs)

ABS-Elektronische Steuergeräte

ABS - Unité de Commande Electronique

Unità di Controllo Elettroniche ABS (ECU)

Part Number	Type Number	Fig.	A	B [V]	C	D	E
0486107503N00	–	17	ABS 6 Premium	12	ABS/ASR 6S/6M		
0486107505N00	–	15	ABS 6 Premium	24	ABS/ASR 4S/4M	Modular	
0486107506N00	–	15	ABS 6 Premium	24	ABS/ASR 4S/4M	Modular	
0486107507N06	–	15	ABS 6 Premium	24	ABS/ASR 4S/4M	Modular	
0486107509N06	–	15	ABS 6 Premium	24	ABS/ASR 4S/4M	Modular	
0486107510N01	–	14	ABS 6 Premium	24	ABS 4S/4M	Modular	
0486107700N03	–	18	ABS 6 Advanced	24	ABS/ASR 4S/4M	Modular	
II30223	ES1080	19	KB3AL	24	ABS 4S/3M	Modular	

	Legend	Legende	Légende	Legenda
A1	Supply	Eingang	Alimentation	Alimentazione
A2	Delivery	Ausgang	Sortie	Uscita
B	Voltage	Spannung	Tension	Tensione
C ₁	Electrical Connection – Bayonet	Elektrischer Anschluss Bajonett	Connecteur électrique à baïonnette	Connessione elettrica a baionetta
C ₂	Electrical Connection – DIN Bayonet	Elektrischer Anschluss DIN Bajonett	Connecteur électrique à DIN baïonnette	Connessione elettrica a DIN baionetta
C ₃	Electrical Connection – Thread M24x1,0	Elektrischer Anschluss Gewinde M24x1,0	Connecteur électrique à M24x1,0	Filettatura connessione elettrica M24x1,0
C ₄	With Adaptor Cable DIN Bayonet to Bayonet	Mit Adapterkabel DIN-Bajonett/Bajonett	Avec câble adaptateur DIN baïonnette en baïonnette	Con Cavo Adattatore DIN Baionetta / Baionetta
C ₅	With Adaptor Cable DIN Bayonet to Thread M24 x 1,0	Mit Adapterkabel DIN-Bajonett/metrisches Gewinde M24x1	Avec câble adaptateur DIN baïonnette en M24x100	Con Cavo Adattatore DIN Baionetta / Filettatura M24 x 1,0
D	Wading capability	Wattfähig	Guéable	Immergibile



Part Number	Type Number	Fig.	A		B [V]	C	D
			1	2			
0265351107100	–	1	M22x1,5	M22x1,5	24	C ₁	
0486201011181	–	2	M22 Voss NG12	M22 Voss NG12	24	C ₂	
0486201017170	–	3	M22 Voss NG12	M22 Voss NG12	24	C ₂	
K015676N00	–	3	M22 Voss NG12	M22 Voss NG12	24	C ₂ , C ₄	
K015677N00	–	3	M22 Voss NG12	M22 Voss NG12	24	C ₂ , C ₅	
K017813N00	–	3	M22 Voss NG12	M22 Voss NG12	12	C ₂	
K021312N06	–		M22x1,5	M22x1,5	24	C ₂	D
K03986	–	3	1/2"-14 NPT	1/2"-14 NPT	24	C ₂	
II17776N00	BR9154	3	M22 Voss NG12	M22 Voss NG12	24	C ₂	
II35462	BR9157	3	M22x1,5	M22x1,5	24	C ₂	
II38659F	BR9163	4	1/2"-14 NPT	1/2"-14 NPT	12	C ₃	
II38660F	BR9164	3	1/2"-14 NPT	1/2"-14 NPT	12	C ₂	
II40872F	BR9166	4	M22x1,5	M22x1,5	12	C ₃	
II41053F	BR9190	4	1/2"-14 NPT	1/2"-14 NPT	24	C ₃	

Legend		Legende	Légende	Legenda
A	Length	Länge	Longueur	Lunghezza
B	Sensor type	Sensor Typ	Type de Capteur	Tipo Sensore
B ₁	90 Degrees with screw mounting	Rechtwinklig mit Befestigungslasche	90 degrés avec montage à vis	90° con vite di fissaggio
B ₂	90 Degrees	Rechtwinklig	Coudé à 90°	Ruotato di 90°
B ₃	Straight	Gerade	Droit	Dritto
C	Electrical connection	Elektrischer Anschluss	Connection électrique	Connessione elettrica
C ₁	Socket type round	Steckdose, rund	Prise femelle type ronde	Presca rotonda
C ₂	Plug type round	Steckerausführung Rund	Prise mâle type ronde	Spina rotonda
C ₃	Plaselec	Plaselec	Plaselec	Plaselec
C ₄	ITT Cannon	ITT Cannon	ITT Cannon	ITT Cannon
C ₅	Deutsch	Deutsch	Deutsch	Deutsch
C ₆	Schlemmer	Schlemmer	Schlemmer	Schlemmer
C ₇	Volvo	Volvo	Volvo	Volvo
C ₈	G & H	G & H	G & H	G & H
D	Protection tube	Shutzrohr	Tube de protection	Tubo di protezione
D ₁	With special protection tube	Mit speziellem Schutzrohr	Avec tube de protection spécial	Con tubo di protezione speciale
D ₂	With corrugated protection tube	Mit gewelltem Schutzrohr	Avec tube de protection	Con tubo di protezione ondulato
E	With Grease and Clamping Sleeve	Mit Schmierstoffe und Klemmhülse	Avec Graissage et Douille de Serrage	Fornita di Grasso e Bussola di Serraggio



Wheel Speed Sensors
Drehzahlsensoren

Capteurs de Vitesse
Sensori di Velocità

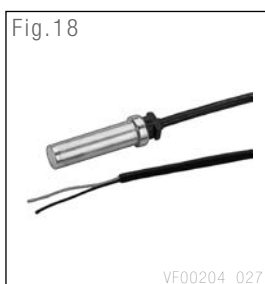

Part Number	Type Number	Fig.	A [m]	B	C	D	E
0265004011170	–		1,4	B ₂	C ₁	–	
0265004012170	–		1,4	B ₂	C ₁	–	
0265004015170	–		1,3	B ₃	C ₁	–	
0265004016170	–		1,5	B ₃	C ₂	–	
0265050102170	–	1	0,475	B ₂	C ₁	D ₁	
0265050103170	–	2	0,475	B ₂	C ₂	D ₁	
0265050109031	–	3	1,4	B ₂	C ₃	D ₂	
0265050110031	–	3	1,4	B ₂	C ₃	D ₂	
0265050112000	–	4	1,87	B ₂	–	D ₂	
0265050118170	–	1	0,515	B ₂	C ₁	D ₂	
0265050119170	–	2	0,515	B ₂	C ₂	D ₂	
0265050141000	–	3	2,1	B ₂	C ₃	D ₂	
0265050142000	–	3	2,1	B ₂	C ₃	D ₂	
04860000192E4	–	5	0,39	B ₂	C ₁	–	
0486000039000	–	5	1,4	B ₂	C ₁	D ₂	
0486000040000	–	6	1,39	B ₂	C ₂	D ₂	
0486000071000	–	7	2,4	B ₂	C ₅	D ₂	
0486000072000	–	7	2,4	B ₂	C ₅	D ₂	
0486000100N00	–	8	0,5	B ₁	C ₁	–	
0486000101N00	–	8	2,0	B ₁	C ₁	–	
0486000102000	–	8	2,5	B ₁	–	–	
0486000103N00	–	9	2,5	B ₁	C ₆	D ₂	
0486000104N00	–	9	2,5	B ₁	C ₆	D ₂	
0486000105000	–		1,45	B ₁	C ₄	D ₂	
0486000106N00	–		1,97	B ₁	C ₄	D ₂	
048600010705T	–		1,0	B ₁	C ₇	D ₂	
0486000108000	–		1,4	B ₁	C ₃	D ₂	
0486000109000	–		1,4	B ₁	C ₃	D ₂	
0486000114999	–	7	3,3	B ₂	C ₅	D ₂	
0486000115999	–	7	3,0	B ₂	C ₅	D ₂	
0486000116100	–	6	1,25	B ₂	C ₂	–	
0486000120N00	–	8	2,5	B ₁	C ₁	D ₂	
0486000121N00	–	8	2,5	B ₁	C ₁	D ₂	
0486000126100	–	1	0,4	B ₂	C ₁	–	

Part Number	Type Number	Fig.	A [m]	B	C	D	E
0486000128100	–	5	1,0	B ₂	C ₁	–	
0486000129100	–	1	2,0	B ₂	C ₁	–	
0486000130100	–	10	2,0	B ₂	–	–	
0486000132100	–	10	2,55	B ₂	–	–	
0486000133000	–	10	2,0	B ₂	–	–	E
0486000134000	–	1	0,4	B ₂	C ₁	–	E
0486000135000	–	1	2,0	B ₂	C ₁	–	E
0486000136000	–	5	1,0	B ₂	C ₁	–	E
0486000137000	–	10	2,55	B ₂	–	–	E
0486000180100	–	10	2,4	B ₂	–	–	
0486000181100	–	10	1,3	B ₂	–	–	
0486000182100	–	11	2,0	B ₂	C ₁	D ₂	
0486000183100	–	6	1,99	B ₂	C ₂	D ₂	
0486000184100	–	9	3,0	B ₂	–	–	
0486000191170	–	5	0,37	B ₂	C ₁	–	
0486000222100	–	12	3,56	B ₂	–	–	
0486000237N00	–	13	1,3	B ₂	C ₆	D ₂	
0486000238N00	–	13	2,0	B ₂	C ₆	D ₂	
0486000239N00	–	13	1,3	B ₂	C ₆	D ₂	
0486000240N00	–	13	2,0	B ₂	C ₆	D ₂	
0486000241N00	–	13	2,0	B ₂	C ₆	D ₂	
0486000242N00	–	13	2,0	B ₂	C ₆	D ₂	
0486000243N00	–	13	3,56	B ₂	C ₆	D ₂	
0486000244181	–	13	3,56	B ₂	C ₆	D ₂	
0486000245181	–	13	3,56	B ₂	C ₆	D ₂	
0486000246N00	–	13	3,56	B ₂	C ₆	D ₂	
0486000247100	–	10	3,0	B ₂	–	–	
0486000250N00	–	7	1,5	B ₂	C ₈	D ₂	
0486000251N00	–	7	1,5	B ₂	C ₈	D ₂	
0486000252N00	–	7	1,85	B ₂	C ₈	D ₂	
0486000253N00	–	7	1,85	B ₂	C ₈	D ₂	
0486000254N00	–	7	2,15	B ₂	C ₈	D ₂	
0486000255N00	–	7	2,15	B ₂	C ₈	D ₂	
0486000256N00	–	7	2,15	B ₂	C ₈	D ₂	
0486000257N00	–	7	2,15	B ₂	C ₈	D ₂	
0486000258N00	–	7	2,8	B ₂	C ₈	D ₂	
0486000259N00	–	7	2,8	B ₂	C ₈	D ₂	
0486000260N00	–	7	1,8	B ₂	C ₈	D ₂	
0486000261N00	–	7	1,8	B ₂	C ₈	D ₂	
0486000263N00	–	7	3,9	B ₂	C ₈	D ₂	
0486000272170	–	5	0,08	B ₂	C ₁	–	
0486000273100	–	6	1,39	B ₂	C ₂	D ₂	

Wheel Speed Sensors
Drehzahlsensoren

Capteurs de Vitesse
Sensori di Velocità

Part Number	Type Number	Fig.	A [m]	B	C	D	E
0486000275000		11	2,0	B ₂	C ₁	D ₂	
0486000276N00	–	7	1,1	B ₂	C ₈	D ₂	
0486000277N00	–	7	1,1	B ₂	C ₈	D ₂	
0486000279N09	–	10	3,56	B ₂	–	–	
0486000282N03	–	11	0,5	B ₂	C ₁	D ₂	
0486000273N03	–	11	1,39	B ₂	C ₁	D ₂	
0486000284N00	–	14	1,0	B ₂	C ₃	D ₂	
0486000285N00	–	14	1,35	B ₂	C ₃	D ₂	
04860010162E4	–	15	1,7	B ₃	C ₁	–	
04860010262E4	–	15	1,0	B ₃	C ₁	–	
0486001032100	–	15	0,3	B ₃	C ₁	–	
0486001033100	–	15	1,0	B ₃	C ₁	–	
0486001041N00	–	16	2,0	B ₃	C ₆	D ₂	
0486001042N00	–	16	2,0	B ₃	C ₆	D ₂	
04860010432E4	–	15	2,0	B ₃	C ₁	–	
0486001064100	–	15	1,65	B ₃	C ₁	–	
0486001066100	–	15	1,7	B ₃	C ₁	–	
0486001067000	–	15	3,0	B ₃	C ₁	–	
0486001072170	–	15	3,4	B ₃	C ₁	–	
0486001073170	–	15	4,0	B ₃	C ₁	–	
0486001074170	–	15	3,6	B ₃	C ₁	–	
0486001075170	–	17	0,24	B ₃	C ₁	–	
0486001076100	–	18	2,4	B ₃	–	–	
0486001077100	–	8	2,05	B ₃	C ₂	–	
0486001080000	–	17	3,0	B ₃	C ₁	D ₂	
0486001084N01	–	17	1,5	B ₃	C ₁	D ₂	
0486002001000	–	19	2,6	B ₁	C ₈	D ₂	
0486002002000	–	19	2,6	B ₁	C ₈	D ₂	
0486002003N00	–	19	1,6	B ₁	C ₅	D ₂	
0486002004N00	–	19	1,6	B ₁	C ₅	D ₂	
0486002005N08	–	20	0,5	B ₁	C ₂	–	

	Page
27.1 ABS System Configuration KB4TA	89
27.2 ABS Trailer Modules / ECUs	92
27.3 ABS Relay Modulators	93
27.4 ABS Accessories	94
	Seite
27.1 ABS-System-Konfigurationen KB4TA	89
27.2 ABS-Anhängermodul / Elektronische Steuergeräte	92
27.3 ABS-Magnetrelaisventil (Modulator)	93
27.4 ABS-Zubehör	94
	Page
27.1 Système ABS-Configuration KB4TA	89
27.2 Module/Unité de Commande Electronique ABS remorque	92
27.3 Modulateur (Valve relais ABS)	93
27.4 Accessoires ABS	94
	Pagina
27.1 Sistemi ABS KB4TA	89
27.2 Unità di Controllo Elettronico/Moduli Rimorchio ABS	92
27.3 Modulatori ABS	93
27.4 Accessori ABS	94

	Legend	Legende	Légende	Legenda
A	Default configuration	voreingestellte Konfiguration	Configuration par défaut	Configurazione predefinita
B	Stop Lamp Power enabled	Bremslichtversorgung möglich	Alimentation Feux stop permis	Alimentazione Luci Stop abilitata
C	AUXIO1 output	Ausgang AUXIO1	Sortie AUXIO1	Uscita AUXIO1
C ₁	Reset to Ride Height	Rückstellung auf Fahrniveau	RTR (Remise hauteur position route)	Reset Altezza Marcia
C ₂	Headboard Warning Lamp	Externe Warnlampe	Lampe d'avertissement	Lampada di Segnalazione in cabina
L	Length	Länge	Longeur	Lunghezza

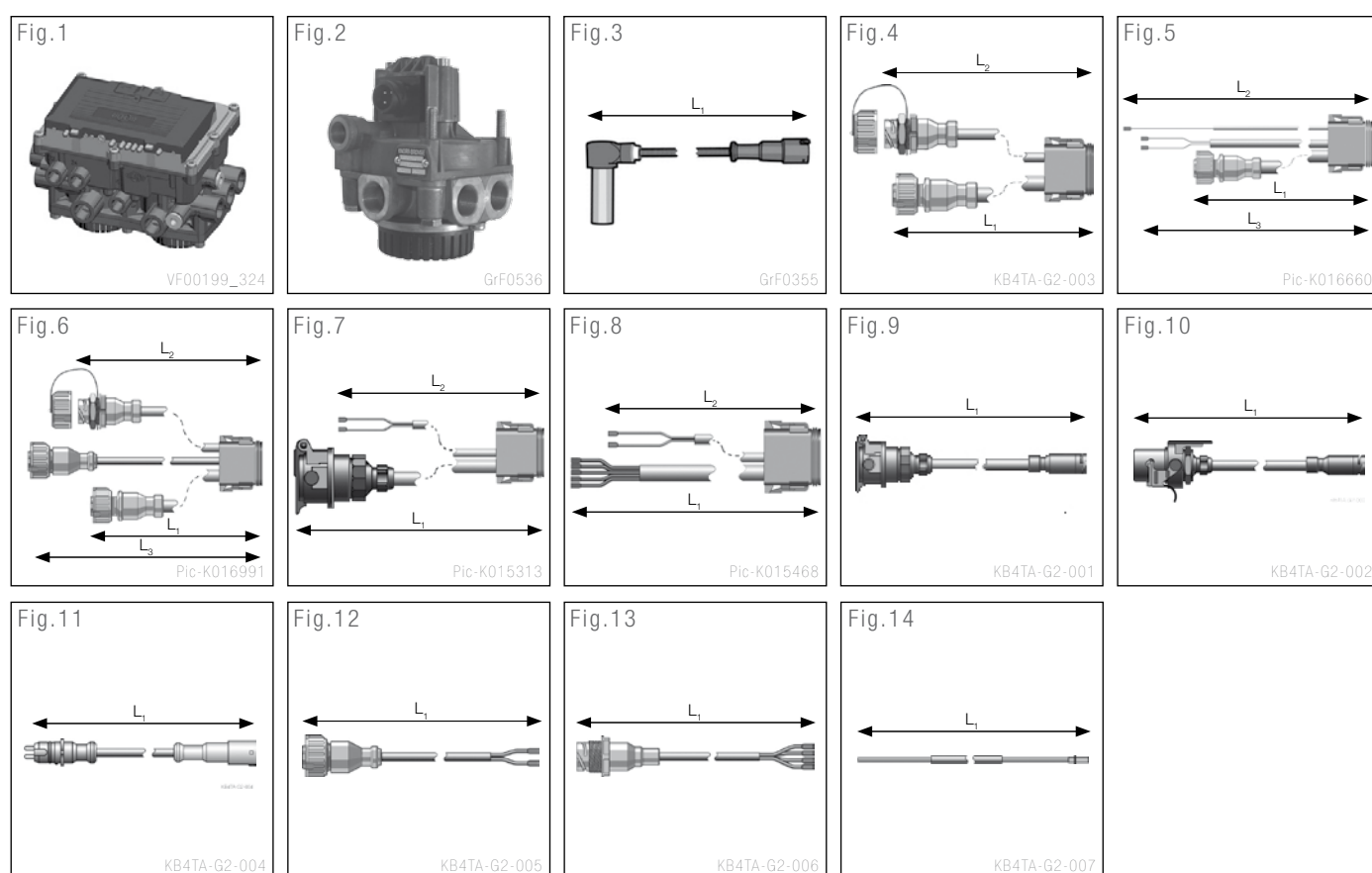

Part No	Type No	Fig.	Description	Beschreibung	Description	Descrizione	A	B	C
K004236	ES1305	1	Trailer Module	ABS-Anhängermodul			2S/2M	B	C ₁
K004246			Module remorque	Modulo			2S/2M	B	C ₂
I137091N00	BR9234	2	ABS Relay Modulator	Magnetrelaisventil (Modulator)	Modulateur (Valve relais ABS)	Modulatore			

Part No	Type No	Fig.	Description Beschreibung Description Descrizione	L ₁	L ₂	L ₃
0486000134000	–	3	Wheel Speed Sensor, with Grease and Clamping Sleeve Drehzahlsensor, mit Schmierstoff und Klemmhülse Capteur de vitesse, avec Graissage et Douille de Serrage Sensore di velocità, fornito di Grasso e Bussola	0.4 m		
K010838N00	–	4	Power Supply Cable (L ₁) and Diagnostic Cable (L ₂) Stromversorgungskabel (L ₁) und Diagnosekabel (L ₂) Câble d'alimentation (L ₁) et Câble Diagnostique (L ₂) Cavo di alimentazione (L ₁) e Cavo Diagnostico (L ₂)	0.5 m	6 m	
K016660N00	–	5	Power Supply Cable (L ₁) with External Headboard Warning Lamp (L ₂) and Stop Lamp Power (L ₃) Spannungsversorgung (L ₁), Externe Warnlampe (L ₂) und Bremslichtansteuerung (L ₃) Câble d'alimentation (L ₁) avec signal d'avertissement externe (L ₂) et alimentation feux stop ISO1185 (L ₃) Cavo di Alimentazione (L ₁) con Lampada di Segnalazione in Cabina esterna (L ₂) e Alimentazione Luci Stop (L ₃)	0.5 m	15 m	15 m
K016991N00	–	6	Power Supply Cable (L ₁), Diagnostic Cable (L ₂) and Cable for 3rd Relay Modulator (L ₃) Spannungsversorgung (L ₁), Diagnose (L ₂) und 3. ABS-Drucksteuerventile (L ₃) Câble d'alimentation (L ₁), câble diagnostique (L ₂) et connexion pour le 3 ^{ème} modulateur (L ₃) Cavo di Alimentazione (L ₁), Cavo Diagnostico (L ₂) e Cavo per il terzo Modulatore (L ₃)	0.5 m	6 m	10 m
K015313N00	–	7	Power Supply Cable with ISO 7638 Socket direct to X1 Connector (L ₁) and Stop Lamp Power (L ₂) Stromversorgungskabel nach ISO 7638 mit Buchse (direkt zum Stecker X1) (L ₁) und Bremslichtansteuerung (L ₂) Câble d'alimentation avec prise ISO 7638 vers connecteur X1 (L ₁) et alimentation feux stop (L ₂) Cavo di Alimentazione con presa ISO 7638 accoppiato al Connettore X1 (L ₁) e Alimentazione Luci Stop (L ₂)	12 m	12 m	
K015468N00	–	8	Power Supply Cable without Socket direct to X1 Connector (L ₁) and Stop Lamp Power (L ₂) Stromversorgungskabel ohne Buchse (direkt zum Stecker X1) (L ₁) und Bremslichtansteuerung (L ₂) Câble d'alimentation sans la prise vers le connecteur X1 (L ₁) et alimentation feux stop (L ₂) Cavo di Alimentazione senza presa accoppiato al Connettore X1 (L ₁) e Alimentazione Luci Stop (L ₂)	12 m	12 m	
2264462397100	–	9	Power Supply Cable ISO 7638 with Socket for semi-trailer Stromversorgungskabel nach ISO 7638 mit Buchse für Sattelanhänger	12 m		
2264462398100			Câble ISO 7638 pour semi-remorque Cavo di alimentazione ISO 7638 con presa per rimorchi	14 m		

Part No	Type No	Fig.	Description Beschreibung Description Descrizione	L ₁	L ₂	L ₃	
K022273N00	-	10	Power Supply Cable ISO 7638 with Plug for drawbar and centre axle trailer	8 m			
K022274N00			Stromversorgungskabel nach ISO 7638 mit Stecker für Deichsel- und Zentralachsanhänger				
	EK3130		Câble ISO 7638 pour remorque à essieu central	10 m			
			Cavo di alimentazione in accordo con ISO 7638 con presa per rimorchi con asse centrale				
II367562000			Extension Cable for Wheel Speed Sensor	2 m			
II367563000				3 m			
II367564000				4 m			
II367565000			Verlängerungskabel für Drehzahlsensor	5 m			
II367566000				6 m			
II367568000			Câble supplémentaire pour capteur de vitesse	8 m			
II3675610000				10 m			
II3675612000			Cavo di prolunga per sensori di velocità	12 m			
II3675615000				15 m			
K002274N00	-		Connecting Cable for 3rd Relay Modulator or RtR function on Raise/Lower Valve	2 m			
K002275N00			Anschlusskabel für 3. ABS-Modulator oder "RtR"-Funktion am Hebe-/Senk-Ventil	6.5 m			
K002276N00			Câble pour le 3 ième modulateur ou fonction RTR sur la valve monte&baisse	10 m			
K017003N00			Cavo di collegamento per il terzo Modulatore o funzione RtR sulla Valvola Alza/Abbassa	15 m			
K013194	-	13	Diagnostic Cable Diagnosekabel Câble Diagnostique Cavo Diagnostico	4 m			
K016629N00	-	14	Cable to External Headboard Warning Lamp	7 m			
K016630N00			Kabel für Externe Warnlampe Câble d'avertissement externe Cavo di segnalazione esterno	15 m			

Legend	Legende	Légende	Legenda
A Application	Anwendung	Application	Applicazione
B Configuration	Konfigurationen	Configuration	Configurazione
C Stop Lamp Power enabled	Bremslichtversorgung möglich	Alimentation Feux stop permis	Alimentazione Luci Stop abilitata
D AUXIO1 output	Ausgang AUXIO1	Sortie AUXIO1	Uscita AUXIO1
D ₁ Reset to Ride Height	Rückstellung auf Fahrniveau	RTR (Remise hauteur position route)	Reset Altezza Marcia
D ₂ Headboard Warning Lamp	Externe Warnlampe	Lampe d'avertissement	Lampada di Segnalazione
E Without ECU	Ohne ECU	Sans ECU	Senza ECU

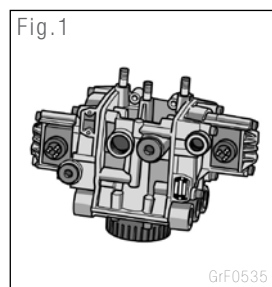

Part Number	Type Number	Fig.	A	B	C	D	E
II30522	BR9231	1	A18	-	-	-	E
II37090N00	BR9233	1	A18	-	-	-	E
K004243	ES1302	2	TABS				
K004236	ES1305	3	KB4TA	2S/2M, 4S/2M & 4S/3M	C	D ₁	
K004246	ES1305	3	KB4TA	2S/2M, 4S/2M & 4S/3M	C	D ₂	
II36413	ES2005	1	A18	2S/2M	-	-	

ABS Relay Modulators
ABS-Magnetrelaisventil (Modulator)

Modulateur (Valve relais ABS)
Modulatore ABS

	Legend	Legende	Légende	Legenda
A1	Supply	Eingang	Alimentation	Alimentazione
A2	Delivery	Ausgang	Sortie	Uscita
A4	Control	Steuerung	Pilotage	Comando
B	Voltage	Spannung	Tension	Tensione
C ₁	Electrical Connection – Bayonet	Elektrischer Anschluss Bajonett	Connecteur électrique à baïonnette	Connessione elettrica a baionetta
C ₂	Electrical Connection – Thread M24x1,0	Elektrischer Anschluss Gewinde M24x1,0	Connecteur électrique à M24x1,0	Filettatura connessione elettrica M24x1,0

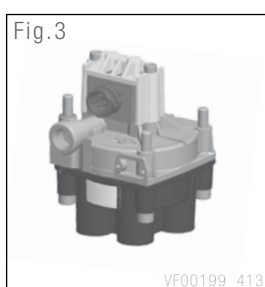
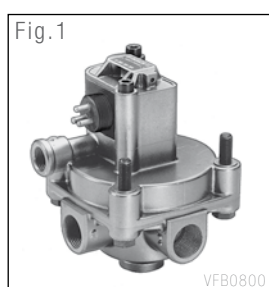

Part Number	Type Number	Fig.	A			B [V]	C
			1	2	4		
0486202001100	–	1	M22x1,5	M22x1,5	M16x1,5	24	C ₁
II37091N00	BR9234	2	M22x1,5	M22x1,5	M16x1,5	24	C ₂
II40868F	BR9235	3	3/4" NPTF	3/8" NPTF	3/8" NPTF	12	C ₁

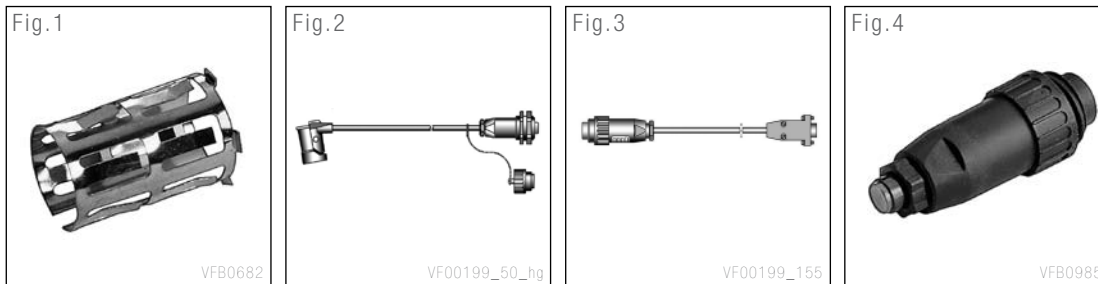

Part Number	Type Number	Fig.	Description	Beschreibung	Description	Descrizione
II16774	-	1	Sensor Bush Klemmhülse Douille de serrage Bussola			
II35418..	EK3050	2	KB3TA Diagnostic Cable (suitable for assembly onto the chassis - available lengths 1 / 3 / 4 / 5 and 8m) Diagnosekabel KB3TA (auch zur Montage am Rahmen geeignet - Längen wahlweise 1 / 3 / 4 / 5 und 8 m) Câble de diagnostic KB3TA (convient pour assemblage sur le châssis - longueurs disponibles 1 / 3 / 4 / 5 et 8 m) Cavo diagnostico KB3TA (adatto al montaggio sul telaio - Lunghezza 1 / 3 / 4 / 5 e 8 metri)			
II354343000	EZ1020	3	Adaptor Cable - KB3TA (connects to Laptop or PC - length 3m) Adapterkabel - KB3TA (zum Anschluss an Laptop oder PC - Länge 3m) Cable de Connexion - KB3TA (connecté à un portable ou un ordinateur - Longueur 3m) Cavo seriale per PC - KB3TA (Lunghezza 3 metri)			
II36381	EZ1022	4	Blinkcode Adaptor - KB3TA & A18 (connects to cable EK3050) Blinkadapter - KB3TA & A18 (zum Anschluss an das Diagnosekabel EK3050) Adaptateur code clignotant - KB3TA & A18 (connecté au cable EK 3050) Adattatore a codice lampeggi per diagnosi ECU - KB3TA & A18 (da connettere al cavo EK 3050)			

See also Section 31 for a full list of Cables and Section 51.1 for Diagnostic Equipment

Siehe auch Abschnitt 31 für die vollständige Auflistung der Kabel und Abschnitt 51.1 für Diagnose-Ausrüstung

Voir la section 31 pour la liste entière des câbles et section 51.1 pour les équipements de diagnostic

Consulta anche la sezione 31 per la lista completa dei Cavi e la sezione 51.1 per la strumentazione Diagnostica

	Page
28.1 EBS One Channel Modules	96
28.2 EBS Two Channel Modules	97
28.3 EBS Foot Brake Modules	98
28.4 EBS Trailer Control Modules	100
28.5 Sensors	101
28.6 EBS Electronic Control Units	103

	Seite
28.1 EBS-Einkanalmodule	96
28.2 EBS-Zweikanalmodule	97
28.3 EBS-Fussbremsmodule	98
28.4 EBS-Anhängersteuermodule	100
28.5 Sensoren	101
28.6 EBS-Elektronische Steuergeräte	103

	Page
28.1 Modules EBS 1 Canal	96
28.2 Modules EBS 2 Canaux	97
28.3 Modules Robinet de Commande à Pied EBS	98
28.4 Modules Commande Remorque EBS	100
28.5 Capteurs	101
28.6 EBS - Unité de Commande Electronique	103

	Pagina
28.1 Moduli EBS a 1 Canale	96
28.2 Moduli EBS a 2 Canali	97
28.3 Moduli Distributore a Pedale EBS	98
28.4 Moduli Comando Rimorchio EBS	100
28.5 Sensori	101
28.6 Unità di Controllo Elettroniche EBS (ECU)	103

	Legend	Legende	Légende	Legenda
A1	Supply	Eingang	Alimentation	Alimentazione
A2	Delivery	Ausgang	Sortie	Uscita
A4	Control	Steuerung	Pilotage	Comando
B	Application	Anwendung	Application	Applicazione
C	Connectors for wheel speed sensors	Anschluss für Drehzahlsensoren	Connecteurs pour Capteurs de vitesse	Connettori per Sensori di Velocità
D	CAN + Umo+BVS	CAN + Umo+BVS	CAN + Umo+BVS	CAN + Umo+BVS
E	Electrical connector	Elektrischer Anschluß	Connexion électrique	Connettore Elettrico
P1	Supply pressure	Betriebsdruck - Eingang	Pression d'alimentation	Pressione alimentazione
P2	Delivery pressure	Betriebsdruck - Ausgang	Pression sortie	Pressione uscita

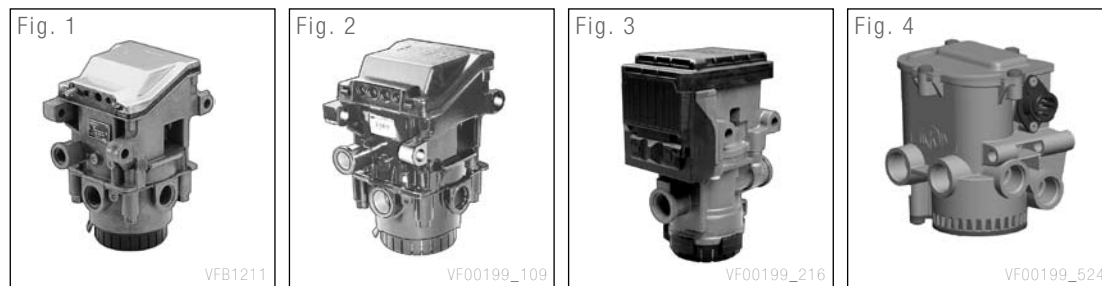

Part Number	Type Number	Fig.	A			B	C	D	E	P	
			1	2	4					1 Max [bar]	2 Max [bar]
0486203023N50	-	1	M22x1,5	M22x1,5	M16x1,5	MAN EBS 2.2/2.3	2	D	G & H	12,5	10,0
0486203025N50	-	2	M22x1,5	M22x1,5	M16x1,5	Scania EBS 2.2	2	D	Deutsch	12,5	10,0
0486203030N50	-	2	M22x1,5	M22x1,5	M16x1,5	RT EBS 2.2	2	D	Deutsch	12,5	10,0
0486203033N50	-	2	M22x1,5	M22x1,5	M16x1,5	Volvo EBS 2.2/2.3	2	D	G & H	12,5	10,0
K021202N50	-	3	M22x1,5	M22x1,5	M16x1,5	Scania EBS 5	2	D	Deutsch	12,5	10,0
K021203N50	-	3	M22x1,5	M22x1,5	M16x1,5	Volvo/RT EBS 5	2	D	Deutsch	12,5	10,0
K021204N50	-	3	M22x1,5	M22x1,5	M16x1,5	MAN EBS 5	2	D	G & H	12,5	10,0
II37083N50	EA2000	4	M22x1,5 Voss	M22x1,5 Voss	M22x1,5 Voss	MB Truck EBS 4	-	-	DIN72585	13,0	10,2

	Legend	Legende	Légende	Legenda
A1	Supply	Eingang	Alimentation	Alimentazione
A2	Delivery	Ausgang	Sortie	Uscita
A4	Control	Steuerung	Pilotage	Comando
B	Application	Anwendung	Application	Applicazione
C	Connectors for wheel speed sensors	Anschluss für Drehzahlsensoren	Connecteurs pour Capteurs de vitesse	Connettori per Sensori di Velocità
D	CAN + Umo+BVS+ALB1/2	CAN + Umo+BVS+ALB1/2	CAN + Umo+BVS+ALB1/2	CAN + Umo+BVS+ALB1/2
E	Electrical connector	Elektrischer Anschluß	Connexion électrique	Connettore Elettrico
F	Wading capability	Wattfähig	Guéable	Immergibile
P1	Supply pressure	Betriebsdruck – Eingang	Pression d'alimentation	Pressione alimentazione
P2	Delivery pressure	Betriebsdruck – Ausgang	Pression sortie	Pressione uscita

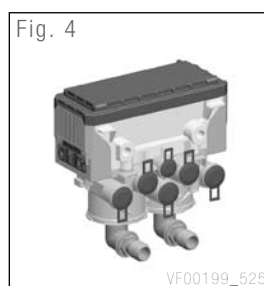
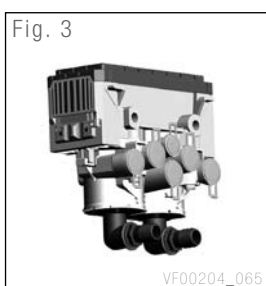

Part Number	Type Number	Fig.	A			B	C	D	E	F	P	
			1	2	4						1 Max [bar]	2 Max [bar]
0486204017N50	–	1	M22x1,5	M22x1,5	M16x1,5	MAN EBS 2.2/2.3	4	D	G & H		12,5	10,0
0486204019N50	–	1	M22x1,5	M22x1,5	M16x1,5	Scania EBS 2.2/2.3	4	D	Deutsch		12,5	10,0
0486204021N50	–	1	M22x1,5	M22x1,5	M16x1,5	RT EBS 2.2	4	D	Deutsch		12,5	10,0
0486204025N50	–	1	M22x1,5	M22x1,5	M16x1,5	Volvo EBS 2.2/2.3	4	D	G & H		12,5	10,0
K000086N50	–	2	M22x1,5	M22x1,5	M16x1,5	Scania EBS 5	4	D	Deutsch		12,5	10,0
K000921N50	–	2	M22x1,5	M22x1,5	M16x1,5	MAN EBS 5	4	D	G&H		12,5	10,0
K000922N50	–	2	M22x1,5	M22x1,5	M16x1,5	Volvo/RT EBS 5	4	D	Deutsch		12,5	10,0
K020023N50	–	2	M22x1,5	M22x1,5	M16x1,5	Volvo/RT EBS 5	4	D	Deutsch		12,5	10,0
K020024N50	–	2	M22x1,5	M22x1,5	M16x1,5	MAN EBS 5	4	D	Deutsch		12,5	10,0
K023215N50	–	3	M22x1,5	M22x1,5	M16x1,5	RT EBS 5	4	D	Deutsch		12,5	10,0
K023216N50	–	4	M22x1,5	M22x1,5	M16x1,5	MAN EBS 5	4	D	Deutsch		12,5	10,0
K032014N50	–	2	M22x1,5	M22x1,5	M16x1,5	Scania EBS 5	4	D	Deutsch		12,5	10,0

Legend	Legende	Légende	Legenda
A1	Supply	Eingang	Alimentation
A2	Delivery	Ausgang	Sortie
B	Application	Anwendung	Application
E	Electrical connector	Elektrischer Anschluß	Connexion électrique
G	Pins	Pins	Pins
J	Actuation	Betätigung	Activation
J ₁	Rod	Stößel	Poussoir
J ₂	Pedal	Trittplatte	Pédale
K	Wading capability	Wattfähig	Guéable
P1	Supply pressure	Betriebsdruck – Eingang	Pression d'alimentation
P2	Delivery pressure	Betriebsdruck – Ausgang	Pression sortie
Q	Ø12 H9	Ø12 H9	Ø12 H9
R	Push-in (Legris)	Steckanschluss (Legris)	En appui (Legris)
S	Push-in	Steckanschluss	En appui
T	Voss 232 NG8	Voss 232 NG8	Voss 232 NG8
U	Voss 232 NG12	Voss 232 NG12	Voss 232 NG12
V	Voltage	Spannung	Tension

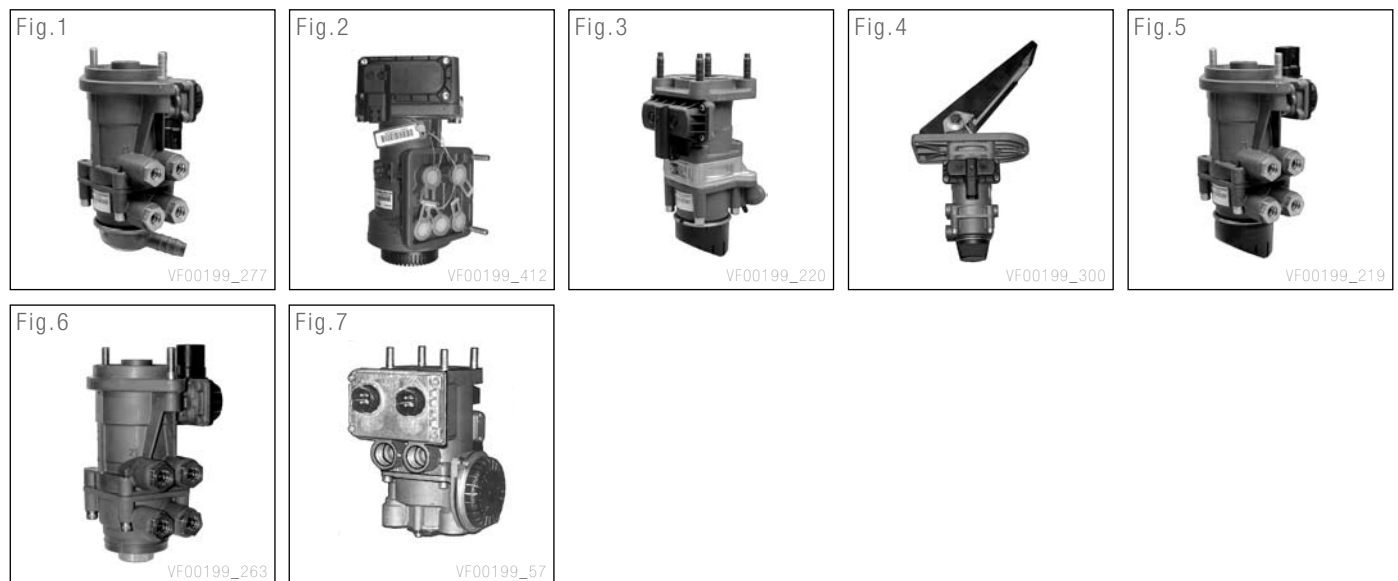

Part Number	Type Number	Fig.	A		B	E	G	J	K	P		V [V]
			1	2						1 Max [bar]	2 Max [bar]	
0486200004N50	–	1	M12x1,5	M12x1,5	Volvo EBS 2.3	G & H	4	J ₁		10,0	–	5
0486200009000	–	2	Q	Q	Scania P4 EBS 2	Deutsch	4	J ₁		11,0	–	5
0486200104N50	–	3	R	R	RT Premium EBS 2	Deutsch	4	J ₁		12,5	8,0	5
0486200202N50	–	4	M12x1,5	M12x1,5	Volvo EBS 2	G & H	4	J ₁		8,0	–	5

EBS Foot Brake Modules
EBS-Fußbremsmodule

Modules Robinet de Commande à Pied EBS
Moduli Distributore a Pedale EBS

Part Number	Type Number	Fig.	A		B	E	G	J	K	P		V [M]
			1	2						1 Max [bar]	2 Max [bar]	
K024928N50	–	4	M12x1,5	M12x1,5	Volvo EBS 5	Deutsch	6	J ₂		10,0	8,5	5
K039530N50	–	5	T	T	MAN TG-A EBS 2	G & H	4	J ₁		12,5	–	5
K039544N50	–	5	T	T	MAN Bus EBS 2	G & H	4	J ₁		12,5	–	5
K039546N50	–	6	T	T	MAN EBS 2	G & H	4	J ₁	K	12,5	–	5
K039569N50	–	5	T	T	MAN EBS 5	G & H	6	J ₁		12,5	–	5
K039571N50	–	6	T	T	MAN EBS 5	G & H	6	J ₁	K	12,5	–	5
K040156N50	–	3	S	S	RT Premium EBS 5	Deutsch	6	J ₁		12,5	–	5
K040158N50	–	3	S	S	RT Magnum EBS 5	Deutsch	6	J ₁		12,5	–	5
K040159N50	–	3	M12x1,5	M12x1,5	Volvo Truck EBS 5	Deutsch	6	J ₁		10,0	–	5
K044694N50	–	1	M12x1,5	M12x1,5	Scania Bus EBS 5	Deutsch	6	J ₁		10,0	–	5
<i>II37181N50</i>	MB9000	7	U	U	MB Atego EBS 4	DIN72585	8	J ₁		13,0	10,2	

	Legend	Legende	Légende	Legenda
A1	Supply	Eingang	Alimentation	Alimentazione
A2	Delivery	Ausgang	Sortie	Uscita
A4	Control	Steuerung	Pilotage	Comando
B	Application	Anwendung	Application	Applicazione
E	Electrical connector	Elektrischer Anschluß	Connexion électrique	Connettore Elettrico
G	Pins	Pins	Pins	Pins
H	Wading capability	Watfähig	Guéable	Immergibile

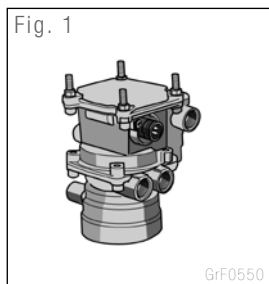

Part Number	Type Number	Fig.	A			B	E	G	H
			1	2	4				
0486205014N50	–	1	M22x1,5	M22x1,5	M16x1,5	Scania EBS 2.2	DIN72585	4	
0486205022N50	–	1	M22x1,5	M22x1,5	M16x1,5	MAN EBS 2.3	DIN72585	4	
ETC1AKN50	–	2	M22x1,5 Voss	M22x1,5 Voss	M16x1,5 Voss	MB Truck EBS 4	DIN72585	6	
K020623N50	–	3	M22x1,5	M22x1,5	M16x1,5	MAN EBS 5	DIN72585	7	
K020624N50	–	3	M22x1,5	M22x1,5	M16x1,5	Volvo EBS 5	DIN72585	7	
K020626N50	–	3	M22x1,5	M22x1,5	M16x1,5	RT EBS 5	DIN72585	7	H

	Legend	Legende	Légende	Legenda
A	Supply	Eingang	Alimentation	Alimentazione
B	Application	Anwendung	Application	Applicazione
C	Electrical connector	Elektrischer Anschluß	Connexion électrique	Connettore Elettrico
D	Pins	Pins	Pins	Pins
P	Supply pressure	Betriebsdruck - Eingang	Pression d'alimentation	Pressione alimentazione
V	Voltage	Spannung	Tension	Tensione

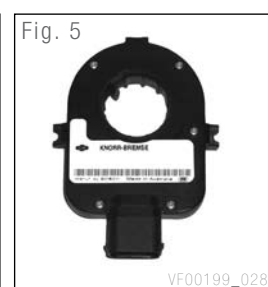
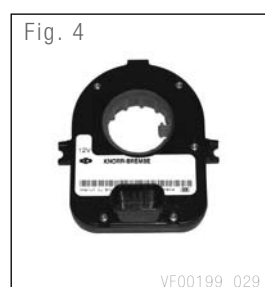
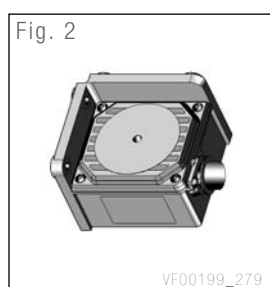

Pressure sensors

Drucksensoren

Capteurs de pression

Sensori di pressione

Part Number	Type Number	Fig.	A	B	C	D	P [bar]
0484205003750	–	1	M16x1,5	Scania	DIN72585	3	0,6 - 21,0
0484205004N50	–	1	M16x1,5	RT	DIN72585	3	0,6 - 21,0
0484205006N00	–	1	M16x1,5	RT	DIN72585	3	0,6 - 21,0
048420500705T	–	1	M16x1,5	Volvo	DIN72585	3	0,6 - 21,0
K015173N00	–	1	M16x1,5		DIN72585	3	0,6 - 13,0

Yaw rate sensors

Drehratensensoren

Capteurs de lacet

Sensori di imbardata

Part Number	Type Number	Fig.	B	C	D	V [V]
0486020002N50	–	2	MAN	DIN72585	4	12
0486020003N50	–	2	Scania	DIN72585	4	12
04860200062E4	–	2		DIN72585	4	12
K020568N50	–	3		DIN72585	4	12

Steering angle sensors

Lenkwinkelsensoren

Capteurs d'angle de direction

Sensori di sterzata

Part Number	Type Number	Fig.	B	C	D	V [M]
0486021003N50	–	4	Scania	RB	7	12
04860210062E4	–	4		RB	7	12
0486021007N50	–	5		RB	7	12
0486021008181	–	5	MAN	RB	7	12
04860210112E4	–	4		RB	7	12
04860210122E4	–	5		RB	7	12

EBS Electronic Control Units (ECUs)
EBS-Elektronische Steuergeräte

EBS - Unité de Commande Electronique
Unità di Controllo Elettroniche EBS (ECU)

Legend	Legende	Légende	Legenda
A Product family	Produktfamilie	Famille de produit	Famiglia di prodotti
B Voltage	Spannung	Tension	Tensione
C Configuration	Konfiguration	Configuration	Configurazione
D Plug type	Stecker Typ	Prise type	Tipo di presa
E Application	Anwendung	Application	Applicazione

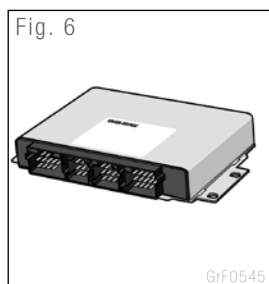

Part Number	Type Number	Fig.	A	B [V]	C	D	E
048610602122E	–	1	EBS 2.2	24	4 EPM	Modular	Scania
0486106041181	–	2	EBS 2.3	24		Modular	MAN
0486106042181	–	2	EBS 2.3	24		Modular	MAN
048610605022E	–	3	EBS 5	24	ESP	Modular	Scania
048610606319Z	–	4	EBS 5	24	4 EPM	Modular	Volvo
048610606419Z	–	4	EBS 5	24	2 EPM	Modular	Volvo
048610606522E	–	5	EBS 5	24		Modular	Scania
0486106081N06	–	3	EBS 5	24	AWD	Modular	RT
0486106082N04	–	5	EBS 5	24	Full	Modular	MAN
0486106083N04	–	5	EBS 5	24	Std	Modular	MAN
0486106084N06	–	6	EBS 5	24	4 EPM	Modular	RT
0486106085N06	–	6	EBS 5	24	2 EPM	Modular	RT
0486106086N04	–	2	EBS 5	24	Full	Modular	MAN
0486106087N04	–	2	EBS 5	24	Std	Modular	MAN
0486106088N03	–	3	EBS 5	24	2 EPM	Modular	Iveco
0486106089N04	–	2	EBS 5	24	Full	Modular	MAN
0486106090N04	–	2	EBS 5	24	Std	Modular	MAN
0486106100N04	–	2	EBS 5	24	Full	Modular	MAN

Part Number	Type Number	Fig.	A	B [V]	C	D	E
0486106101N04	–	2	EBS 5	24	Std	Modular	MAN
0486106102N07	–	4	EBS 5	24	4 EPM	Modular	Volvo
0486106103N07	–	4	EBS 5	24	2 EPM	Modular	Volvo
0486106104N05	–	3	EBS 5	24	ESP	Modular	Scania
0486106105N05	–	3	EBS 5	24		Modular	Scania
0486106106N00	–	3	EBS 5	24	4EPM/ESP	Modular	
0486106107N00	–	3	EBS 5	24	4EPM	Modular	
0486106108N03	–	3	EBS 5	24	4EPM/ESP	Modular	
0486106109N03	–	3	EBS 5	24	2EPM/ESP	Modular	
0486106110N06	–	3	EBS 5	24	4EPM/ESP	Modular	RT
0486106111N06	–	3	EBS 5	24	2EPM/ESP	Modular	RT
0486106112N06	–	3	EBS 5	24	4EPM/AWD	Modular	RT
0486106301N04	–	2	EBS 5	24	Full	Modular	MAN

Note: all replacement EBS electronic control units require programming either using data mirroring or by the Vehicle Manufacturer with suitable dataset.

Hinweis: Alle ersetzten EBS-Elektroniksteuergeräte müssen programmiert werden, entweder durch Kopieren der Daten oder durch den Fahrzeughersteller mit dem passenden Datensatz.

Remarque: Tout remplacement des unités de commande électronique EBS exige une programmation, soit en utilisant l'effet miroir ou par le constructeur du véhicule avec les données approprié.

Nota: tutte le sostituzioni di unità controllo elettroniche EBS richiedono una programmazione mediante data mirroring oppure tramite Costruttore Veicolo con un idoneo set di dati.

	Page
29.1 EBS System Configuration TEBS G2 & 2.1	106
29.2 Trailer EBS Brake Modules	112
29.3 Trailer Electro-Pneumatic Modules (TEPM)	113
29.4 Trailer Roadtrain Module (TRM)	113

	Seite
29.1 EBS-System-Konfigurationen TEBS G2 & 2.1	106
29.2 Anhänger-EBS-Bremsmodule	112
29.3 Trailer Elektropneumatische Module (TEPM)	113
29.4 Trailer Roadtrain Modul (TRM)	113

	Page
29.1 Système EBS-Configuration TEBS G2 & 2.1	106
29.2 Modules de Freinage EBS pour Remorque	112
29.3 Modules Remorque Electropneumatiques (TEPM)	113
29.4 Trailer Roadtrain Module (TRM)	113

	Pagina
29.1 EBS - Sistemi TEBS G2 & 2.1	106
29.2 Moduli di Frenatura Rimorchio EBS	112
29.3 Trailer Electro-Pneumatic Modules (TEPM)	113
29.4 Trailer Roadtrain Module (TRM)	113

Legend		Legende	Légende	Legenda
A	Ports	Anschlüsse	Raccords	Raccordi
A ₁	Metric	metrisch	Métrique	Metrico
A ₂	Push-in	pneumatischer Steckanschluss	En appui	A innesto
B	Integral charging valve	Integriertes Überströmventil	Valve de Barrage intégrée	Valvola Pressione Controllata integrata
C	Includes non-return valve	Einschließlich Sperrventil	Valve anti-retour intégrée	Valvola di non ritorno integrata
D	Pinned red button	Roter Knopf stiftgesichert	Bouton rouge avec goupille	Bottono rosso con spina
E	Integral front axle valve			
F	Operation	Betätigung	Fonctionnement	Azionamento
F ₁	Electrical	Elektrisch	Electrique	Elettrico
F ₂	Air	(Druck-) Luft	Air	Pneumatico
G	With mounting plate	Mit Montageplatte	Avec Bride	Con Flangia
L	Length	Länge	Longueur	Lunghezza



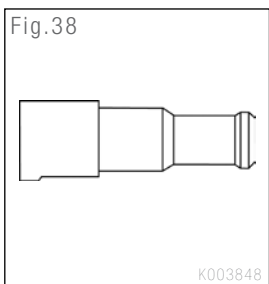
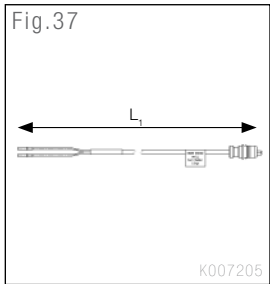
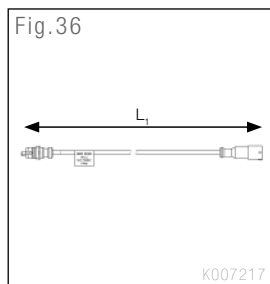
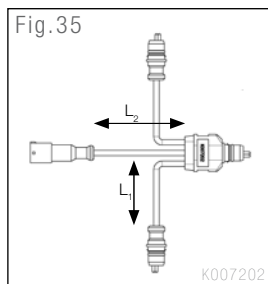
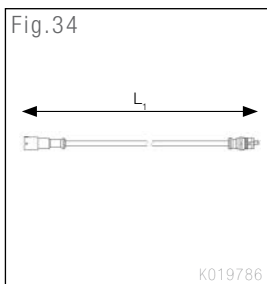
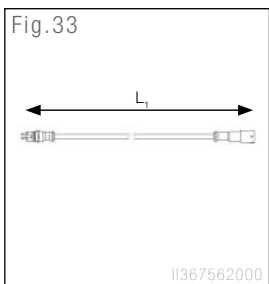
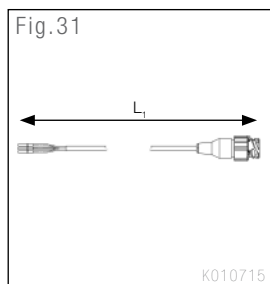
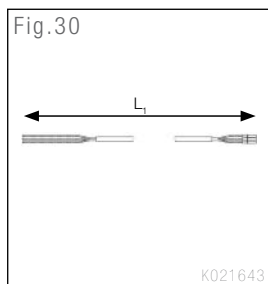
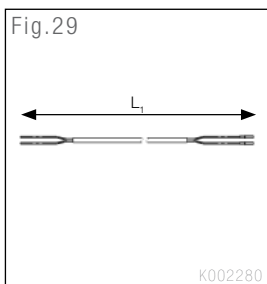
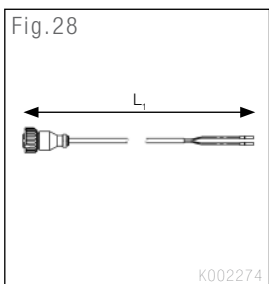
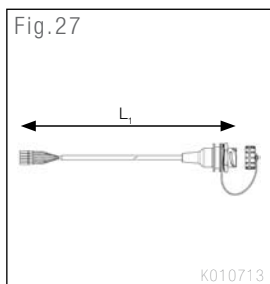
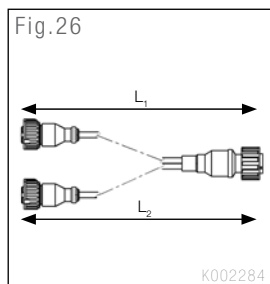
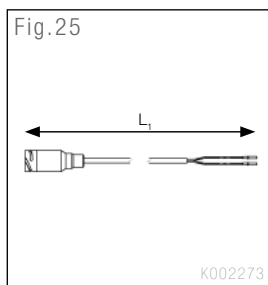
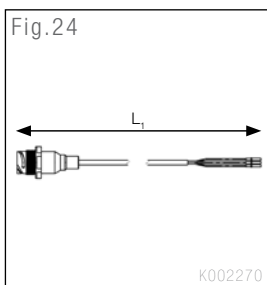
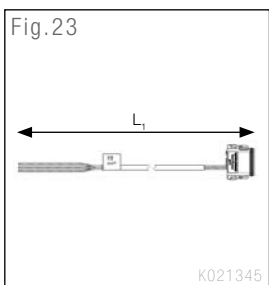
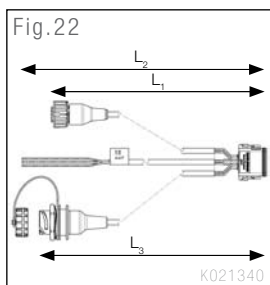
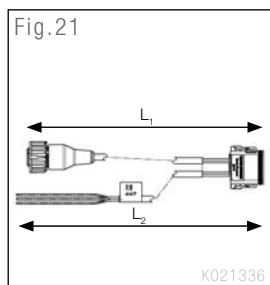
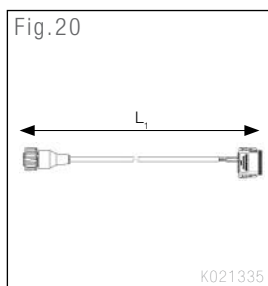
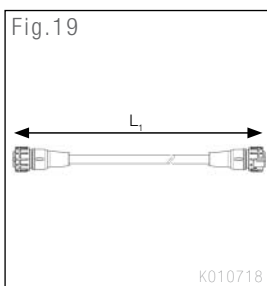
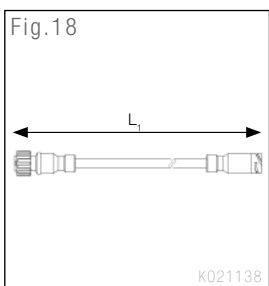
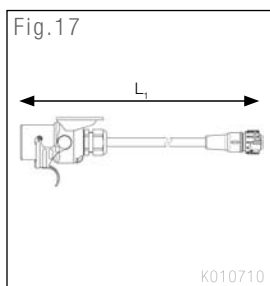
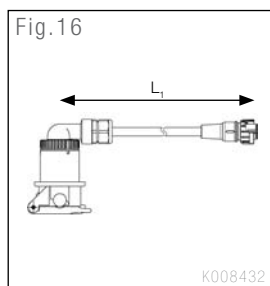

Description	Beschreibung	Description	Descrizione	Part Number	Type Number	Fig.	A	B
Trailer EBS Brake Module (TEBS G2)								
Anhänger-EBS-Bremsmodul (TEBS G2)				<i>K019340V02N50</i>	ES2060	1	A ₁	
Module de Freinage EBS pour Remorque (TEBS G2)				<i>K019342V02N50</i>			A ₂	
Modulo di Frenatura Rimorchio EBS (TEBS G2)								
Trailer EBS Brake Module (TEBS G2.1)								
Anhänger-EBS-Bremsmodul (TEBS G2.1)				<i>K019350V02N00</i>	ES2060	2	A ₁	
Module de Freinage EBS pour Remorque (TEBS G2.1)				<i>K019352V02N00</i>			A ₂	
Modulo di Frenatura Rimorchio EBS (TEBS G2.1)								

Description	Beschreibung	Description	Descrizione	Part Number	Type Number	Fig.	A	B	C	D	E
Park/Shunt Valve (without integrated emergency function)	Kombilöseventile	Valve de Desserrage/Stationnement	Valvola di Sfrenatura	<i>II36128</i>	AE4230	3	A ₁	-	-	-	-
				<i>II36129</i>	AE4247	3	A ₁	-	-	D	-
				<i>II36131</i>	AE4247	3	A ₁	-	C	D	-
Park/Shunt Valve with integrated emergency function	Kombilöseventil mit Notfunktion	Valve de Desserrage/Stationnement avec fonction urgence	Valvola di Sfrenatura con funzione di emergenza integrata	<i>K025700N00</i>	AE4370	4	A ₂	B	-	-	-
				<i>K025699</i>	AE4371	4	A ₂	B	-	-	E
Park/Shunt Valve with integrated emergency function	Kombilöseventil mit Notfunktion	Valve de Desserrage/Stationnement avec fonction urgence	Valvola di Sfrenatura con funzione di emergenza integrata	<i>K015380N00</i>	AE4311	5	A ₁	B	-	-	-
				<i>K015849N00</i>		6	A ₁	-	-	-	-
				<i>K020123N00</i>		5	A ₂	B	-	-	-

Description	Beschreibung	Description	Descrizione	Part Number	Type Number	Fig.
Relay Emergency Valve						
Anhängerbremsventil				AS3050A	-	7
Valve Relais d'Urgence						
Servoautodistributore						
Trailer Electro-Pneumatic Module Standard (TEPM-S)						
Trailer Elektropneumatisches Modul Standard (TEPM-S)				<i>K021940V00N00</i>	ES2070	8
Module Remorque Electropneumatique Standard (TEPM-S)						
Trailer Electro-Pneumatic Module Standard (TEPM-S)						
Trailer Electro-Pneumatic Module Premium (TEPM-P)						
Trailer Elektropneumatisches Modul Premium (TEPM-P)				<i>K027900V00N00</i>	ES2071	9
Module Remorque Electropneumatique Premium (TEPM-P)						
Trailer Electro-Pneumatic Module Premium (TEPM-P)						

Description	Beschreibung	Description	Descrizione	Part Number	Type Number	Fig.	F
Lift Axle Control Valve				<i>K008546</i>	AE1141	10	F ₁
Liftachsventil				<i>K015384N00</i>		11	F ₁
Valve de Relevage d'Essieu				<i>K017224N00</i>		12	F ₂
Valvola di Controllo Sollevamento Asse				<i>K019882N00</i>		11	F ₁

Description	Beschreibung	Description	Descrizione	Part Number	Type Number	Fig.	C	G
Raise / Lower Valve								
Hebe- / Senkventil				<i>K002018</i>	SV3240	13	C	G
Monte et Baisse								
Valvola Comando Container								

Description	Beschreibung	Description	Descrizione	Part Number	Type Number	Fig.
Trailer Information Module (TIM G2)				K009166V02N00	EZ1035	14
Trailer Info Modul (TIM G2)						
Module d'Information Remorque (TIM G2)						
Trailer Information Module (TIM G2)						

Description	Beschreibung	Description	Descrizione	Part Number	Type Number	Fig.	L1	L2	L3		
Power Supply Cable ISO 7638 with socket for semi-trailer				K008430N00	-	15	10 m				
Stromversorgungskabel nach ISO 7638 mit Steckdose für Sattelanhänger							K008431N00	-	13 m		
Cable ISO 7638 pour semi-remorque											
Cavo di alimentazione ISO 7638 per semirimorchi											
Power Supply Cable ISO 7638 with socket for semi-trailer – 90° Connector				K008432N00	-	16	16 m				
Stromversorgungskabel nach ISO 7638 mit abgewinkelter 90° Steckdose für Sattelanhänger											
Cable d'alimentation ISO 7638 pour semi-remorque – Prise à 90°											
Cavo di alimentazione ISO 7638 per semirimorchi – Connettore 90°											
Power Supply Cable ISO 7638 with plug for drawbar and centre axle trailer				K010710N00	-	17	10 m				
Stromversorgungskabel nach ISO 7638 mit Stecker für Deichsel- und Zentralachsanhänger							K010711N00	-	13 m		
Cable ISO 7638 pour remorque à essieu central											
Cavo di alimentazione ISO 7638 con presa per rimorchi con asse centrale											
Power Supply Extension Cable				K021138N00	-	18	4 m				
Verlängerungskabel für Stromversorgung											
Cable d'extension pour alimentation											
Cavo di alimentazione - Prolunga											
Power Supply Adaptor Cable 12 V				K010718N00	-	19	0.5 m				
Adapterkabel Stromversorgung 12 V											
Cable adaptateur pour alimentation 12 V											
Cavo adattatore d'alimentazione 12 V											
In-Out cable for AUX function (2 pin)				K021335N00	-	20	6.5 m				
'In-Out'-Kabel für AUX-funktion (2-adrig)											
Cable In-Out pour fonction AUX (2 pin)											
Cavo In-Out per funzioni AUX (2 pin)											
In-Out cable for AUX function (2 pin - L1), Stop Lamp and 'Traction Help' with open ends (3 pin - L2)				K021336N00	-	21	6.5 m	7 m			
'In-Out'-Kabel für AUX-funktion (2-adrig - L1), Bremslichtversorgung und Anfahrhilfe mit offenen Kabelenden (3-adrig - L2)											
Cable In-Out pour fonction AUX (2 pin - L1), Feux stop et 'aide au démarrage' avec extrémité dénudée (3 plots - L2)											
Cavo per funzioni AUX (2 pin - L1), Luci Stop e 'Traction Help' con uscite aperte (3 pin - L2)											

Description	Beschreibung	Description	Descrizione	Part Number	Type Number	Fig.	L1	L2	L3
In-Out cable for AUX function (2 pin - L1), Stop Lamp and 'Traction Help' with open ends (3 pin - L2) and Diagnostic Socket (5 pin - L3)				K021340N00	-	22	6.5 m	7 m	6 m
'In-Out'-Kabel für AUX-funktion (2-adrig - L1), Bremslichtversorgung und Anfahrhilfe mit offenen Kabelenden (3-adrig - L2) und Diagnoseanschluss (5-adrig - L3)									
Cable In-out pour fonction AUX (2 pin - L1). Feu stop et 'aide au démarrage' avec extrémité dénudée (3 plots - L2) et prise diagnostique (5 plots- L3)									
Cavo per funzioni AUX (2 pin - L1), Luci Stop e 'Traction Help' con uscite aperte (3 pin - L2) e presa Diagnostica (5 pin - L3)									
In-Out cable for Stop Lamp and 'Traction Help' with open ends (3 pin)				K021345N00	-	23	7 m		
'In-Out'-Kabel für Bremslichtversorgung und Anfahrhilfe mit offenen Kabelenden (3-adrig)									
Cable In-Out pour feux stop et 'aide au démarrage' avec extrémité dénudée (3 plots)									
Cavo per Luci Stop e 'Traction Help' con uscite aperte (3 pin)									
In-Out Modular Cable for 'Magic Eye' or for use as a 'Bayonet Splitter' (3 pin)				K002270 K002271	-	24	2 m		
modulares 'In-Out'-Kabel für Anschluss 'Magic Eye' oder 'Bajonett-Splitter' (3-adrig)									
Cable Modulable In-Out par 'œil magique' ou pour une utilisation en 'bayonnette Splitter' (3 plots)									
Cavo Modulare per 'Magic Eye' o 'Splitter a Baionetta' (3 pin)									
In-Out Modular Cable for use as a 'Bayonet Splitter' (2 pin)				K002273	-	25	6 m		
modulares 'In-Out'-Kabel als 'Bajonett-Splitter' (2-adrig)									
Cable Modulable In-Out pour une utilisation en 'bayonnette Splitter' (2 plots)									
Cavo Modulare per 'Splitter a Baionetta' (2 pin)									
In-Out Modular Connection Cable for two valves				K002285	-	26	0.5 m	0.5 m	
modulares 'In-Out'-Anschlusskabel für den Anschluss von zwei Ventilen									
Cable de connexion modulable In-Out pour deux valves									
Cavo di Connessione Modulare per due valvole									
Diagnostic Cable (5 pin)				K010713N00	-	27	6 m		
Diagnosekabel (5-adrig)									
Cable Diagnostique (5 pin)									
Cavo Diagnostico (5 pin)									
Modular Connecting Cable for AUX functions (2 pin)				K002274N00 K002275N00 K002276N00 K017003N00	-	28	2 m		
modulares Anschlusskabel für AUX-Funktionen (2-adrig)									
Cable de connexion modulable pour fonctions AUX (2 plots)									
Cavo Modulare di Connessione per funzioni AUX (2 pin)									
Stop Lamp Cable with open ends (2 pin)				K002280N00 K002281N00	-	29	7 m		
Anschlusskabel Bremslichtversorgung mit offenen Kabelenden (2-adrig)									
Cable feu stop avec extrémité dénudée (2 plots)									
Cavo Luci Stop con uscite aperte (2 pin)									

Description Beschreibung Description Descrizione	Part Number	Type Number	Fig.	L1	L2	L3
Stop Lamp and 'Traction Help' Cable with open ends (3 pin) Anschlusskabel Bremslichtversorgung und Anfahrhilfe mit offenen Kabelenden (3-adrig) Cable feu stop et 'aide au démarrage' avec extrémité dénudée (3 plots) Cavo Luci Stop e 'Traction Help' con uscite aperte (3 pin)	K021643N00 K021644N00	– –	30	7 m 15 m		
Stop Lamp and 'Traction Help' Cable (3 pin) Anschlusskabel Bremslichtversorgung und Anfahrhilfe (3-adrig) Cable feu stop et 'aide au démarrage' (3 plots) Cavo Luci Stop e 'Traction Help' (3 pin)	K010715N00 K010716N00	– –	31	1 m 7 m		
Parts Kit for In-Out Connector Teilesatz Verschlussstecker für 'In-Out'-Anschluss am EBS-Anhängersmodul Kit de pieces pour connecteur In-Out Connettore per Kit	K002287N00	–	32			
Extension Cable for Wheel Speed Sensor Verlängerungskabel für Drehzahlsensor Cable supplémentaire pour capteur de vitesse Cavo di prolunga per sensori di velocità	II367562000 II367563000 II367564000 II367565000 II367566000 II367568000 II3675610000 II3675612000 II3675615000	EK3130	33	2 m 3 m 4 m 5 m 6 m 8 m 10 m 12 m 15 m		
Pad Wear Connection Cable Anschlusskabel für Bremsbelagverschleiß-Sensierung Cable de connexion pour témoin d'usure Cavo di Connessione Usura Pastiglie	K019786N00	–	34	1 m		
Pad Wear Axle Module Achsmodule Bremsbelagverschleiß Module d'essieu de témoin d'usure Modulo Usura Pastiglie Assale	K007202	–	35	2 m	2 m	
Pad Wear Extension Cable Verlängerungskabel Bremsbelagverschleiß Cable d'extension pour témoin d'usure Cavo di prolunga per Usura Pastiglie	K007217 K007218 K007219	– – –	36	1 m 3 m 5 m		
Pad Wear Connection Cable (one bare end) Anschlusskabel Bremsbelagverschleiß (ein offenes Kabelende) Cable de connexion pour témoin d'usure (une extrémité dénudée) Cavo di Connessione Usura Pastiglie (una uscita aperta)	K007205	–	37	1 m		
Pad Wear End Connector Abschlußstecker Bremsbelagverschleiß Connecteur de fermeture de témoin d'usure Tappo di chiusura Usura Pastiglie	K003848	–	38			

	Legend	Legende	Légende	Legenda
A11	Supply	Eingang Druckversorgung	Alimentation	Alimentazione
A12	Spring Brake Control from Park/Shunt Valve	Steuerung der Feststellbremse durch Kombilöseventil	Pilotage Cylindre venant Robinet de Frein de Parc	Controllo spring brake tramite valvola di sfrenatura/parcheggio
A21	Delivery to Service Brake Actuators	Ausgang Betriebsbremse	Sortie vers la chambre avant des cylindres	Uscita attuatori frenatura di servizio
A22	Delivery to Spring Brakes/Auxiliaries	Ausgang Federspeicherbremse/Aux	Sortie vers la chambre arrière des cylindres/auxiliaires	Uscita spring brake/servizi ausiliari
A4	Control - Coupling Head/Air Suspension Signal	Steuerung - Kupplungskopf/Lasterfassung Luftfederbalg	Pilotage-Tête d'accouplement/Signal suspension d'air	Controllo - Giunto Accoppiamento/Segnale aria sospensioni
B	Application	Anwendung	Application	Applicazione
K	Configuration	Konfiguration	Configuration	Configurazione
L	Roll Stability Program (RSP)	Fahrstabilitätsprogramm (RSP)	Programme d'aide à la Stabilité (RSP)	Roll Stability Program (RSP)
R	Port 28 Configuration	Konfiguration Anschluss 28	Configuration orifice 28	Configurazione Porta 28
R ₁	Speed pulse	Geschwindigkeitsimpuls	Impulsion vitesse	Impulso velocità
R ₂	Test Point for Service Brake Delivery	Messstelle für Ausgang Betriebsbremse	Point test pour sortie frein de service	Preso Pressione Frenatura di Servizio
S	'Smart Update' feature	'Smart update'-Einrichtung	Mise à Jour Automatique ('Smart Update')	Caratteristica 'Smart Update'
¹⁾	Port 1.2 plugged	Anschluss 1.2 verschlossen	Orifice 1.2 bouché	Porta 1.2 tappata
²⁾	Push-in	Steckanschluss	En appui	A innesto

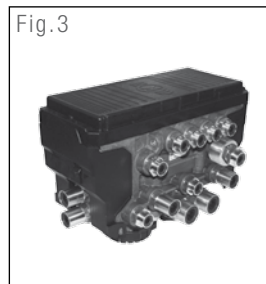
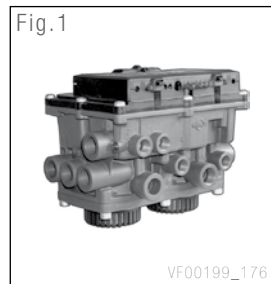

Part Number	Type Number	Fig.	A					B	K	L	R	S
			11	12	21	22	4					
II397824S3M	ES2053	1	M22x1,5	M16x1,5	M22x1,5	M16x1,5	M16x1,5	TEBS 4	2S/2M-4S/3M	L	-	-
II39782PG	ES2053	1	M22x1,5 ¹⁾	M16x1,5	M22x1,5	M16x1,5	M16x1,5	TEBS 4	2S/2M-4S/3M	L	-	-
K019300V03N50	ES2060	2	M22x1,5	M16x1,5	M16x1,5	M16x1,5	M16x1,5	TEBS G2	2S/2M-6S/3M	L	R ₁	-
K019302V03N50	ES2060	2	15x1,5 ²⁾	12x1,5 ²⁾	12x1,5 ²⁾	8x1,0 ²⁾	8x1,0 ²⁾	TEBS G2	2S/2M-6S/3M	L	R ₁	-
K019312V04N00	ES2060	3	15x1,5 ²⁾	12x1,5 ²⁾	12x1,5 ²⁾	8x1,0 ²⁾	8x1,0 ²⁾	TEBS G2.1	2S/2M-6S/3M	L	R ₁	S
K019340V02N50	ES2060	2	M22x1,5	M16x1,5	M16x1,5	M16x1,5	M16x1,5	TEBS G2	2S/2M	L	R ₂	-
K019342V02N50	ES2060	2	15x1,5 ²⁾	12x1,5 ²⁾	12x1,5 ²⁾	8x1,0 ²⁾	8x1,0 ²⁾	TEBS G2	2S/2M	L	R ₂	-
K019350V02N00	ES2060	3	M22x1,5	M16x1,5	M16x1,5	M16x1,5	M16x1,5	TEBS G2.1	2S/2M	L	R ₂	S
K019352V02N00	ES2060	3	15x1,5 ²⁾	12x1,5 ²⁾	12x1,5 ²⁾	8x1,0 ²⁾	8x1,0 ²⁾	TEBS G2.1	2S/2M	L	R ₂	S

	Legend	Legende	Légende	Legenda
A1	Supply	Eingang Druckversorgung	Alimentation	Alimentazione
A2	Delivery to Service Brake Actuators	Ausgang Betriebsbremse	Sortie vers la chambre avant des cylindres	Uscita attuatori frenatura di servizio
A4	Control - Coupling Head	Steuerung - Kupplungskopf	Pilotage-Tête d'accouplement	Controllo - Giunto Accoppiamento
A42	Air Suspension Signal	Lasterfassung Luftfederbalg	Signal suspension pneumatique	Segnale aria sospensioni

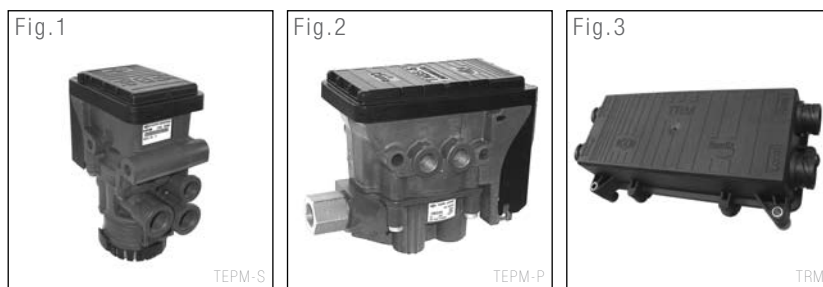

29.3

Trailer Electro-Pneumatic Modules
Trailer Elektropneumatisches Module
Modules Remorque Electropneumatique
Trailer Electro-Pneumatic Modules

Part Number	Type Number	Fig.	A				
			1	2	4	42	
K021940V00N00	ES2070	1	M22x1,5	M22x1,5	M16x1,5	–	Standard (TEPM-S)
K027900V00N00	ES2071	2	M22x1,5	M22x1,5	M16x1,5	M16x1,5	Premium (TEPM-P)

29.4

Trailer Roadtrain Module (TRM)
Trailer Roadtrain Modul (TRM)
Trailer Roadtrain Module (TRM)
Trailer Roadtrain Module (TRM)

Part Number	Type Number	Fig.
K036198V00N00	EZ2085	3

	Page
30.1 Power Supply Cables	115
30.2 Connecting Cables and Harnesses	117
30.3 Adapter Cables	120
30.4 Extension Cables	121
30.5 Diagnostic Cables	123
	Seite
30.1 Stromversorgungskabel	115
30.2 Anschlusskabel und Kabelbäume	117
30.3 Adapterkabel	120
30.4 Verlängerungskabel	121
30.5 Diagnosekabel	123
	Page
30.1 Câbles d'alimentation	115
30.2 Câbles de Connexion et Faisceaux	117
30.3 Câbles Adaptateur	120
30.4 Câbles Prolongateur	121
30.5 Câbles Diagnostic	123
	Pagina
30.1 Cavi d'alimentazione	115
30.2 Cavi di Collegamento e Cablaggi	117
30.3 Cavi Adattatori	120
30.4 Cavi di Prolunga	121
30.5 Cavi di Diagnosi	123

Legend		Legende		Légende		Legenda	
L	Length	Länge	Longeur	Lunghezza			
L ₁	Power Supply Cable ISO 7638	Stromversorgungskabel nach ISO 7638	Cable ISO 7638	Cavo di alimentazione in accordo con ISO 7638			
L ₂	Power Supply Cable ISO 1185	Stromversorgungskabel nach ISO 1185	Cable ISO 1185	Cavo di alimentazione in accordo con ISO 1185			
L ₃	Aux	Aux	Aux	Aux			
L ₄	Diagnostic Cable	Diagnosekabel	Câble diagnostic	Cavo Diagnostico			

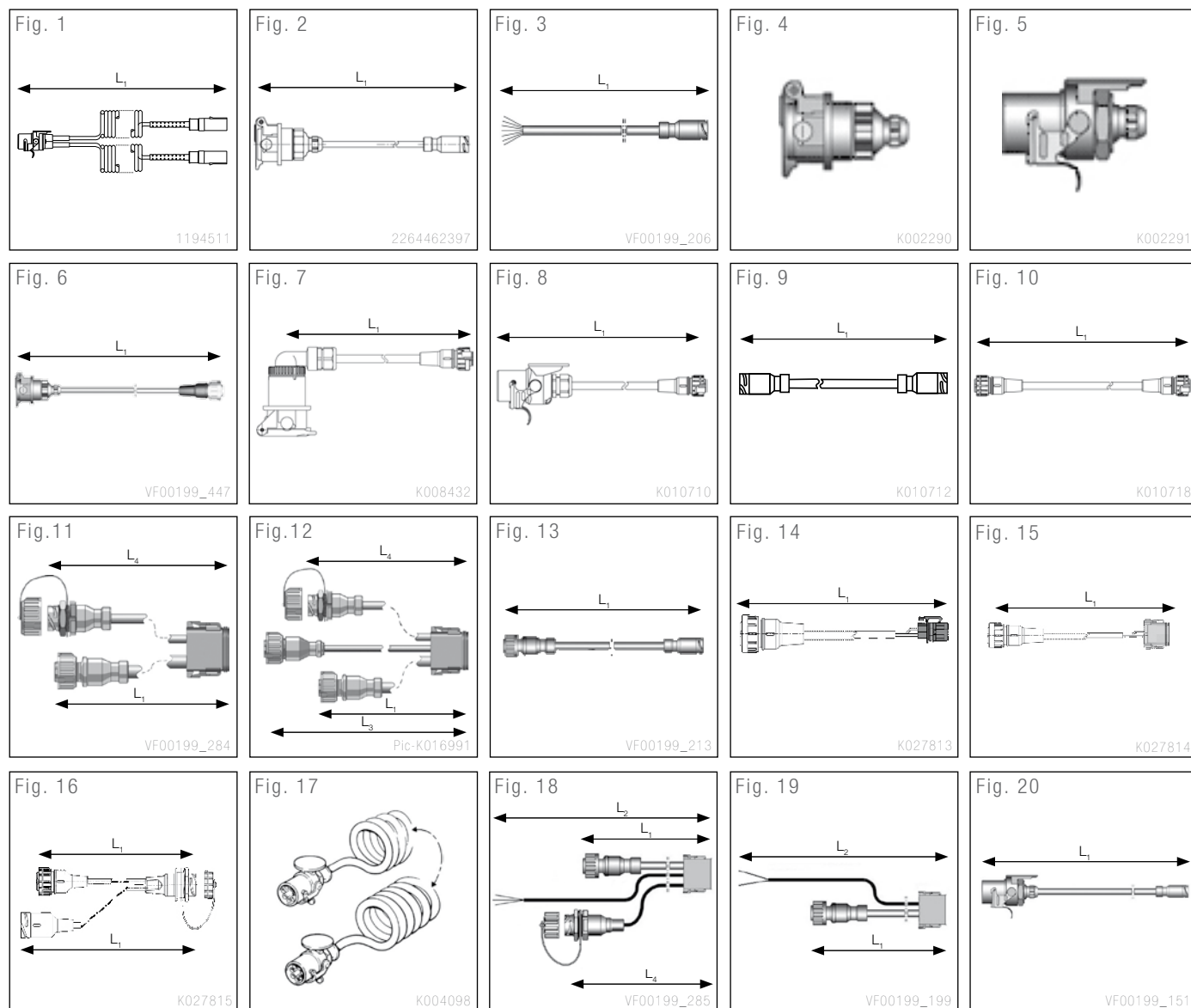

Part Number	Type Number	Fig.	L ₁ [m]	L ₂ [m]	L ₃ [m]	L ₄ [m]
1194511SP	-	1	1,0 - 4,0			
2264462369000	-		12,0	-	-	5,0
2264462397100	-	2	12,0	-	-	-
2264462398100	-	2	14,0	-	-	-
K002289	-	3	17,5	-	-	-
K002290	-	4	-	-	-	-
K002291	-	5	-	-	-	-
K008430N00	-	6	10,0	-	-	-
K008431N00	-	6	13,0	-	-	-
K008432N00	-	7	16,0	-	-	-
K010710N00	-	8	10,0	-	-	-
K010711N00	-	8	13,0	-	-	-
K010712N00	-	9	13,0	-	-	-
K010717N00	-	6	12,0	-	-	-
K010718N00	-	10	0,5	-	-	-
K010838N00	-	11	0,5	-	-	6,0
K016991N00	-	12	0,5	-	10,0	6,0
K021138N00	-	13	4,0	-	-	-
K027813N00	-	14	3,0	-	-	-
K027814N00	-	15	3,0	-	-	-
K027815N00	-	16	1,0/3,0	-	-	-
K028000N00	-	13	2,0	-	-	-
K028001N00	-	13	10,0	-	-	-
K028491N00	-	6	0,5	-	-	-
K028583N00	-	7	13,0	-	-	-
KB7638	-	17	1,0 - 4,0	-	-	-
II367397	EK3100	18	0,5	12,0	-	6,0
II40391F2	EK3108	19	0,5	12,0	-	-
II3674112000	EK3110	2	12,0	-	-	-
II3674115000	EK3110	2	15,0	-	-	-
II3979312000	EK3115	20	12,0	-	-	-
K004098N00	EK3150	17	1,0 - 4,0	-	-	-

Legend		Legende		Légende		Legenda	
L	Length	Länge		Longeur		Lunghezza	
L ₁	Aux 1	Aux 1		Aux 1		Aux 1	
L ₂	Aux 2	Aux 2		Aux 2		Aux 2	
L ₃	Sensor A	Sensor A		Capteur A		Sensore A	
L ₄	Sensor B	Sensor B		Capteur B		Sensore B	
L ₅	Sensor C	Sensor C		Capteur C		Sensore C	
L ₆	Power Supply Cable ISO 7638	Stromversorgungskabel nach ISO 7638		Cable ISO 7638		Cavo di alimentazione in accordo con ISO 7638	
L ₇	Power Supply Cable ISO 1185	Stromversorgungskabel nach ISO 1185		Cable ISO 1185		Cavo di alimentazione in accordo con ISO 1185	
L ₈	Diagnostic Cable	Diagnosekabel		Câble diagnostic		Cavo Diagnostico	

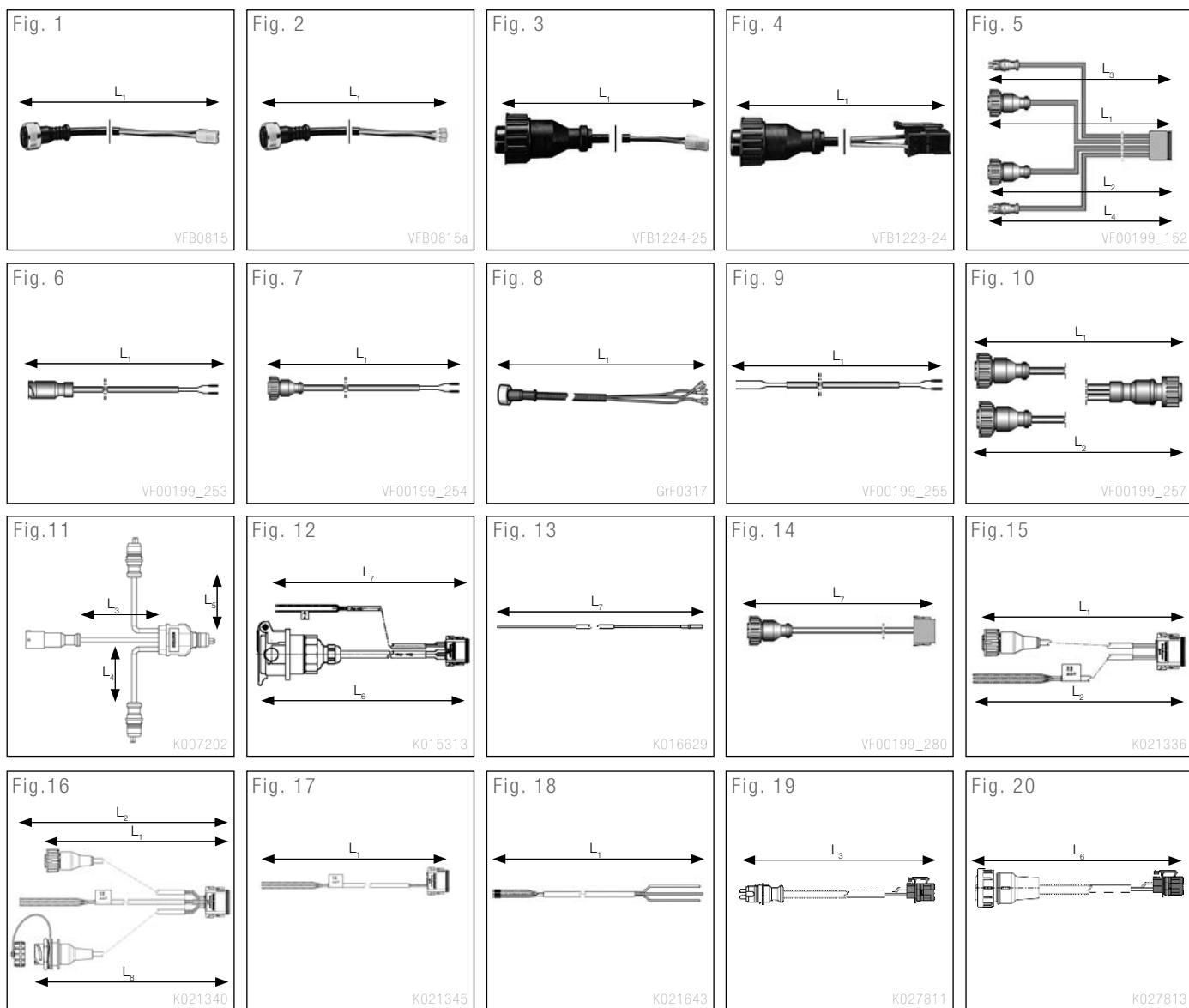

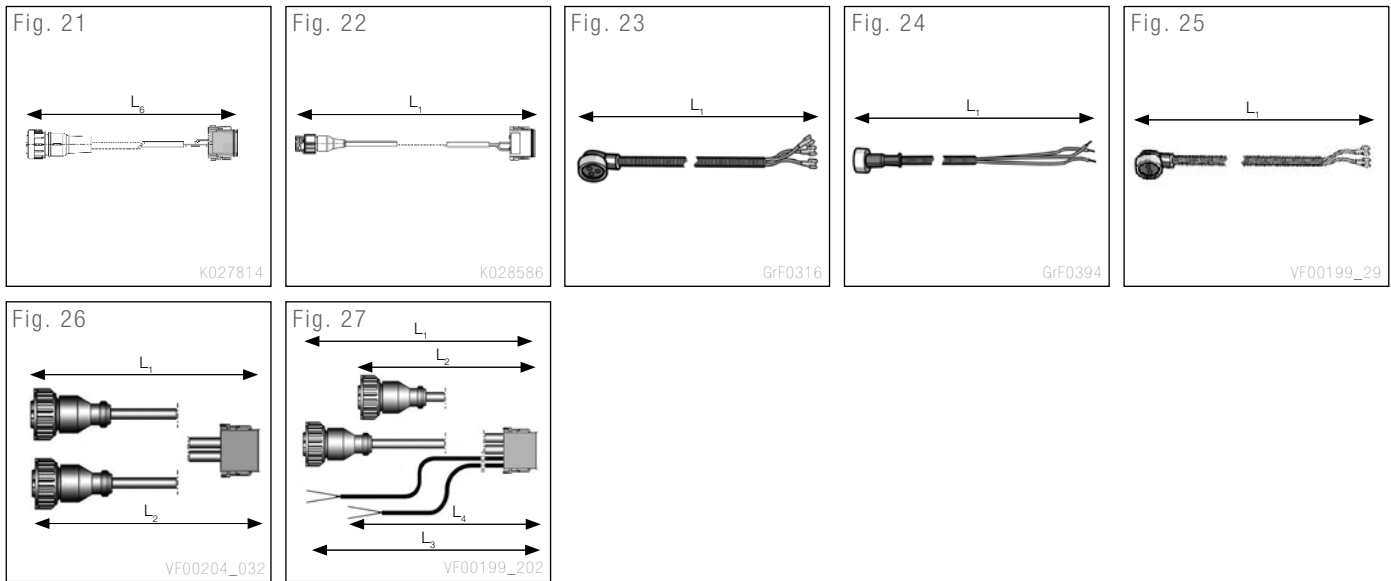

Part Number	Type Number	Fig.	L ₁ [m]	L ₂ [m]	L ₃ [m]	L ₄ [m]	L ₅ [m]	L ₆ [m]	L ₇ [m]	L ₈ [m]
2264461308000	-	1	6,0	-	-	-	-	-	-	-
2264461310100	-	2	12,0	-	-	-	-	-	-	-
2264461324000	-	3	6,0	-	-	-	-	-	-	-
2264461327000	-	3	12,0	-	-	-	-	-	-	-
2264461331000	-	4	6,0	-	-	-	-	-	-	-
2264462353000	-	4	6,0	-	-	-	-	-	-	-
2264462373000	-	5	3,0	3,0	0,5	05,	-	-	-	-
K002273	-	6	6,0	-	-	-	-	-	-	-
K002274N00	-	7	2,0	-	-	-	-	-	-	-
K002275N00	-	7	6,5	-	-	-	-	-	-	-
K002276N00	-	7	10,0	-	-	-	-	-	-	-
K002277N00	-	8	3,0	-	-	-	-	-	-	-
K002278N00	-	8	9,0	-	-	-	-	-	-	-
K002279N00	-	9	15,0	-	-	-	-	-	-	-
K002280N00	-	9	7,0	-	-	-	-	-	-	-
K002281N00	-	9	15,0	-	-	-	-	-	-	-
K002285	-	10	0,5	0,5	-	-	-	-	-	-
K007202	-	11	-	-	2,0	2,0	2,0	-	-	-
K015313N00	-	12	-	-	-	-	-	12,0	12,0	-
K016629N00	-	13	-	-	-	-	-	-	7,0	-
K016630N00	-	13	-	-	-	-	-	-	15,0	-
K017003N00	-	7	15,0	-	-	-	-	-	-	-
K021335N00	-	14	6,5	-	-	-	-	-	-	-
K021336N00	-	15	6,5	7,0	-	-	-	-	-	-
K021337N00	-	15	6,5	15,0	-	-	-	-	-	-
K021338N00	-	15	2,0	7,0	-	-	-	-	-	-

Part Number	Type Number	Fig.	L ₁ [m]	L ₂ [m]	L ₃ [m]	L ₄ [m]	L ₅ [m]	L ₆ [m]	L ₇ [m]	L ₈ [m]
K021340N00	–	16	6,5	7,0	–	–	–	–	–	6,0
K021342N00	–	16	2,0	7,0	–	–	–	–	–	6,0
K021343N00	–	16	2,0	15,0	–	–	–	–	–	6,0
K021345N00	–	17	7,0	–	–	–	–	–	–	–
K021346N00	–	17	15,0	–	–	–	–	–	–	–
K021643N00	–	18	7,0	–	–	–	–	–	–	–
K021644N00	–	18	15,0	–	–	–	–	–	–	–
K027811N00	–	19	–	–	2,0	–	–	–	–	–
K027813N00	–	20	–	–	–	–	–	3,0	–	–
K027814N00	–	21	–	–	–	–	–	3,0	–	–
K028586N00	–	22	1,5	–	–	–	–	–	–	–
I9725512000	EK3010	23	12,0	–	–	–	–	–	–	–
I972553000	EK3010	23	3,0	–	–	–	–	–	–	–
I972559000	EK3010	23	9,0	–	–	–	–	–	–	–
II141563000	EK3011	24	3,0	–	–	–	–	–	–	–
II141564000	EK3011	24	4,0	–	–	–	–	–	–	–
II141566000	EK3011	24	6,0	–	–	–	–	–	–	–
II141568000	EK3011	24	8,0	–	–	–	–	–	–	–
II1415612000	EK3011	24	12,0	–	–	–	–	–	–	–
I977045000	EK3015	25	5,0	–	–	–	–	–	–	–
I9770410000	EK3015	25	10,0	–	–	–	–	–	–	–
II397873	EK3122	26	6,0	6,0	–	–	–	–	–	–
II397883	EK3123	14	6,0	–	–	–	–	–	–	–
II39814F1	EK3127	27	6,0	2,0	15,0	7,0	–	–	–	–
K002954	EK3142	14	9,0	–	–	–	–	–	–	–

30 (30.3)

Adapter Cables
Adapterkabel

Câbles Adaptateur
Cavi Adattatori

Legend		Legende		Légende		Legenda	
L	Length	Länge		Longueur		Lunghezza	
B	ESP (SAS)	ESP (SAS)		ESP (SAS)		ESP (SAS)	

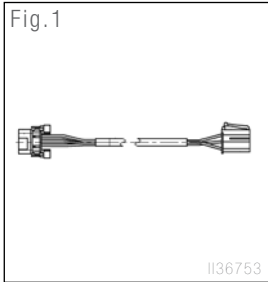

Part Number	Type Number	Fig.	L [m]	B
1136753	EK3800	1	0,29	B

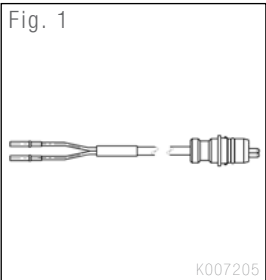
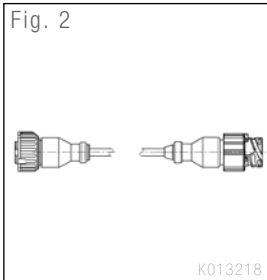
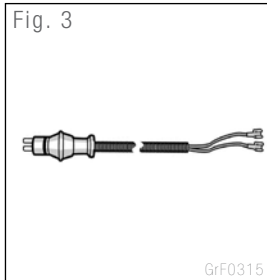
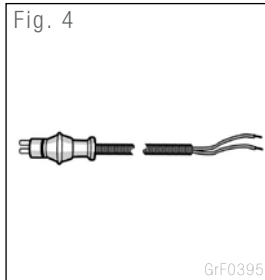
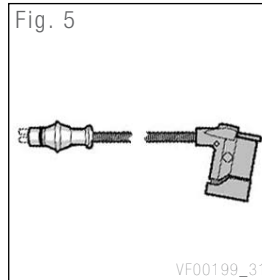
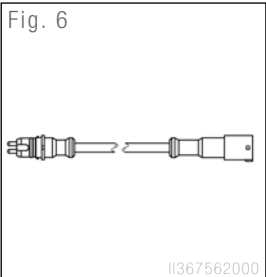
Legend	Legende	Légende	Legenda
L Length	Länge	Longueur	Lunghezza
Fig. 1  K007205	Fig. 2  K013218	Fig. 3  GrF0315	Fig. 4  GrF0395
Fig. 5  VF00199_31	Fig. 6  II367562000		

Part Number	Type Number	Fig.	L [m]
K007205	-	1	1,0
K013218N00	-	2	4,0
I970215000	EK3000	3	5,0
I970218000	EK3000	3	8,0
I9702110000	EK3000	3	10,0
I9702112000	EK3000	3	12,0
I9702115000	EK3000	3	15,0
EK3001800	EK3001	4	0,8
EK30011200	EK3001	4	1,2
EK30012500	EK3001	4	2,5
EK30013500	EK3001	4	3,5
EK30014000	EK3001	4	4,0
EK30014500	EK3001	4	4,5
EK30018500	EK3001	4	8,5
II156393000	EK3001	4	3,0
II156395000	EK3001	4	5,0
II156396000	EK3001	4	6,0
II156398000	EK3001	4	8,0
II1563910000	EK3001	4	10,0
II1563912000	EK3001	4	12,0
II354163000	EK3003	5	3,0

30 (30.4)

Extension Cables
Verlängerungskabel

Câbles Prolongateur
Cavi di Prolunga

Part Number	Type Number	Fig.	L [m]
<i>II354166000</i>	EK3003	5	6,0
<i>II3675610000</i>	EK3130	6	10,0
<i>II3675615000</i>	EK3130	6	15,0
<i>II367562000</i>	EK3130	6	2,0
<i>II367563000</i>	EK3130	6	3,0
<i>II367564000</i>	EK3130	6	4,0
<i>II367565000</i>	EK3130	6	5,0
<i>II367566000</i>	EK3130	6	6,0
<i>II367568000</i>	EK3130	6	8,0

Legend		Legende		Légende		Legenda	
L	Length	Länge		Longeur		Lunghezza	
L ₁	Power Supply Cable ISO 7638	Stromversorgungskabel nach ISO 7638		Cable ISO 7638		Cavo di alimentazione in accordo con ISO 7638	
L ₂	Power Supply Cable ISO 1185	Stromversorgungskabel nach ISO 1185		Cable ISO 1185		Cavo di alimentazione in accordo con ISO 1185	
L ₃	Aux	Aux		Aux		Aux	
L ₄	Diagnostic Cable	Diagnosekabel		Câble diagnostic		Cavo Diagnostico	

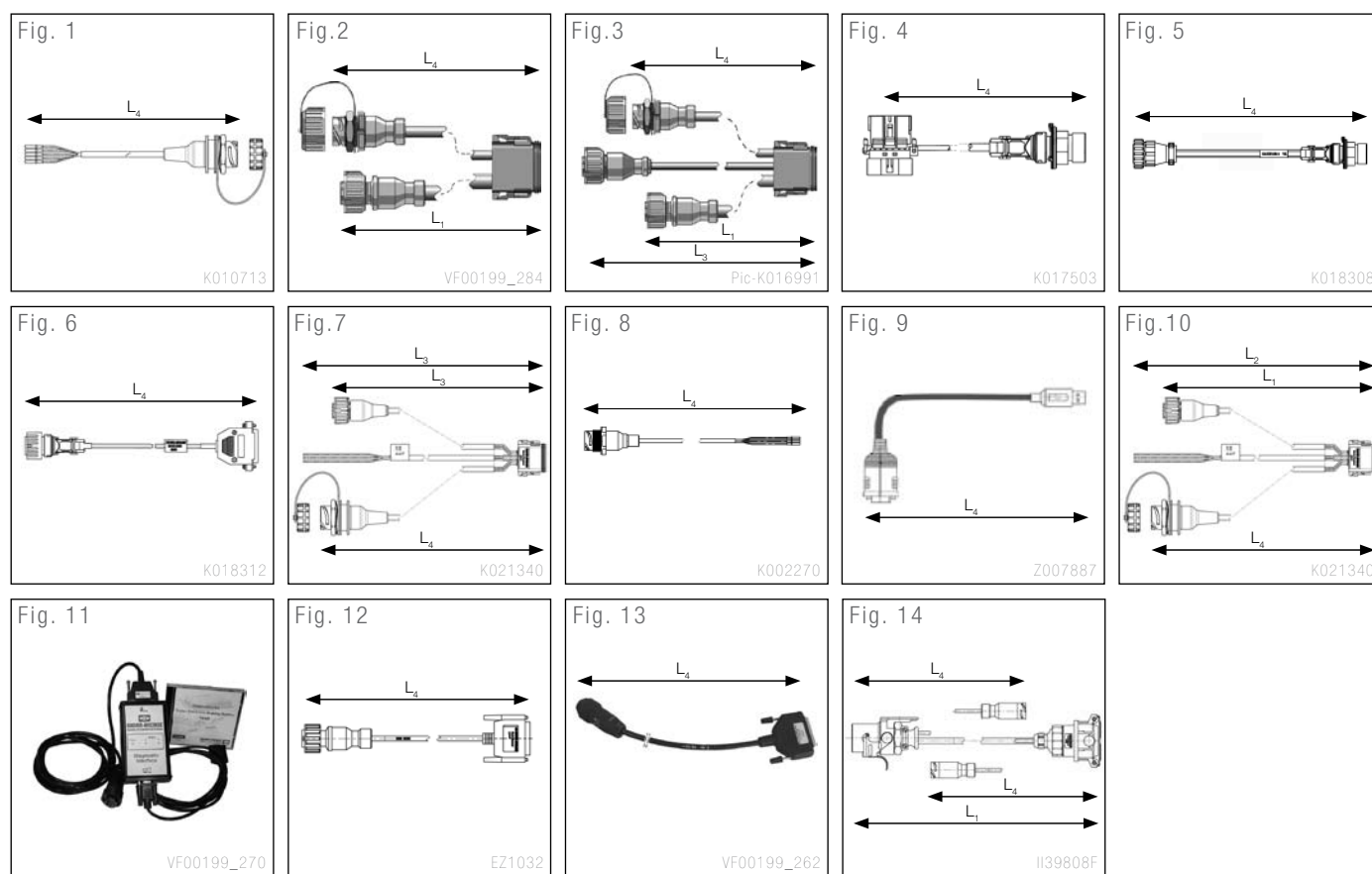

Part Number	Type Number	Fig.	L ₁ [m]	L ₂ [m]	L ₃ [m]	L ₄ [m]
K010713N00	-	1	-	-	-	6,0
K010838N00	-	2	0,5	-	-	6,0
K016991N00	-	3	0,5	-	10,0	6,0
K017503N00	-	4	-	-	-	1,2
K018308N00	-	5	-	-	-	0,2
K018310N00	-	5	-	-	-	0,2
K018312N00	-	6	-	-	-	1,8
K021340N00	-	7	-	-	7,5, 6,5	6,0
K021342N00	-	7	-	-	7,0, 2,0	6,0
K021343N00	-	7	-	-	15,0 2,0	6,0

30 (30.5)

Diagnostic Cables
Diagnosekabel

Câbles Diagnostic
Cavi di Diagnosi

Part Number	Type Number	Fig.	L ₁ [m]	L ₂ [m]	L ₃ [m]	L ₄ [m]
K022272N00	-	8	-	-	-	4,0
K022279N00	-	8	-	-	-	6,0
Z007887	-	9	-	-	-	1,8
II367397	EK3100	7	0,5	12,0	-	6,0
II39809F	EZ1031	10	-	-	-	3,0, 3,0
II39812F	EZ1032	11	-	-	-	3,0
Z005464	EZ1033	12	-	-	-	3,0
II39808F	EZ1034	13	0,45	-	-	0,6, 0,35
K010837N00	EZ1037	11	-	-	-	3,0

	Page
31.1 Brake Chambers (S Cam) – Diaphragm	126
31.2 Brake Chambers (S Cam) – Piston	128
31.3 Brake Chambers (Wedge) – Thread Mounted	129
31.4 Brake Chambers (Wedge) – Flange Mounted	131
31.5 Brake Chambers (Disc)	132
31.6 Brake Chambers (Air/Hyd) – Diaphragm	136
	Seite
31.1 Membranbremszylinder für S-Nockenbremse	126
31.2 Kolbenbremszylinder für S-Nockenbremse	128
31.3 Membranbremszylinder für Keilspreibremse, mit Gewindebefestigung	129
31.4 Membranbremszylinder für Keilspreibremse, mit Flanschbefestigung	131
31.5 Membranbremszylinder für Scheibenbremse	132
31.6 Vorspannzylinder – Membran	136
	Page
31.1 Vases pour Frein à Came - Membrane	126
31.2 Vases pour Frein à Came – Piston	128
31.3 Vases pour Frein à Coin – Vissé	129
31.4 Vases pour Frein à Coin – Bride	131
31.5 Vases à Diaphragme (Disque)	132
31.6 Vases à Membrane Air / Hyd	136
	Pagina
31.1 Elementi Frenanti (Camma a “S”) – Membrana	126
31.2 Elementi Frenanti (Camma a “S”) – Stantuffo	128
31.3 Elementi Frenanti (Freni a Cuneo) – Con Canotto	129
31.4 Elementi Frenanti (Freni a Cuneo) – Flangiati	131
31.5 Elementi Frenanti (Disco)	132
31.6 Convertitori Pneumoidraulici – Membrana	136

31 (31.1)

Brake Chambers (S Cam) – Diaphragm Membranbremszylinder für S-Nockenbremse

Vases pour Frein à Came - Membrane Elementi Frenanti (Camma a "S") – Membrana

Legend	Legende	Légende	Legenda
A	Port size	Anschlussgewinde	Raccord
B	Type	Art	Tipo
C	Stroke	Hub	Course
D	Push rod length (to yoke pin centre if fitted)	Kolbenstangenlänge (gemessen Mitte Gabelkopfbohrung bis Flansch)	Longueur de la tige (à l'axe de chape)
E	Push rod	Kolbenstange	Tige
F	Push rod thread length	Gewindelänge	Longueur filetée de la tige
G	Yoke fitted	Gabelkopf montiert	Equipée de chape
H	Mounting holes	Montagebohrungen	Trous de montage
I	Mounting studs	Stehbolzen	Goujons de montage
J	Mounting nuts fitted	Mit Befestigungsmuttern	Equipée d'écrous de montage
K	Double diaphragm	Doppelmembran	Double membrane

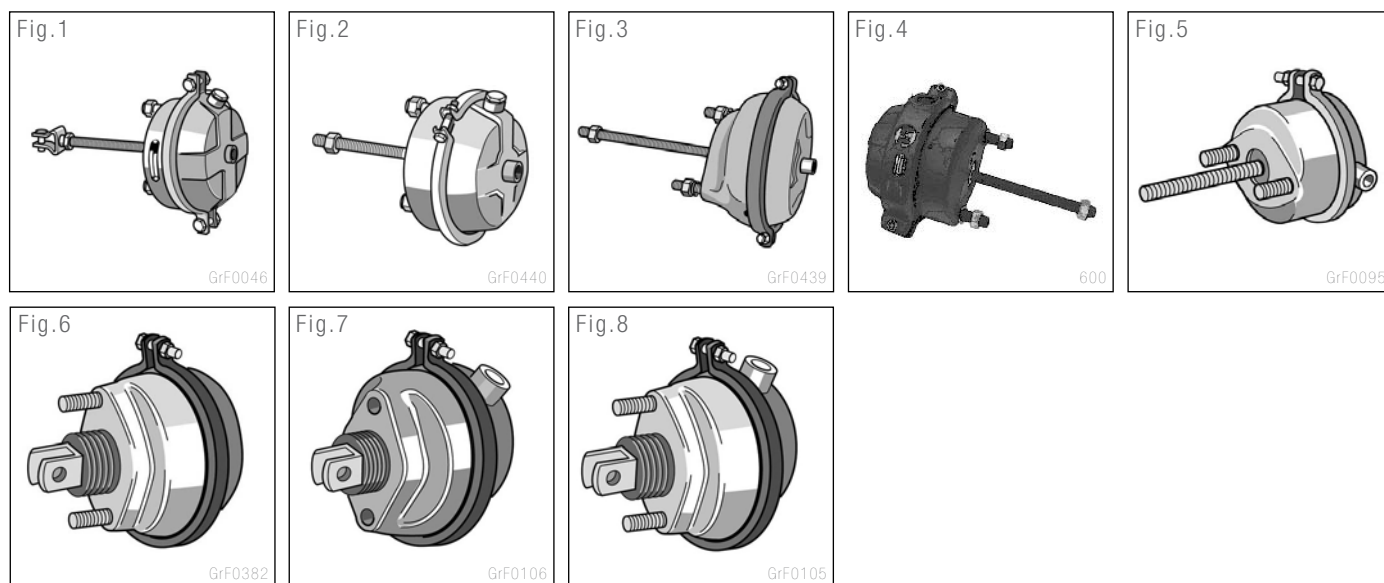

Part Number	Type Number	Fig.	A	B	C [mm]	D [mm]	E	F [mm]	G	H	I	J	K
1186699-05	-	1	M16x1,5	16	64	70	M16x1,5	50	G		M16x1,5	-	
1186699-06	-	1	M16x1,5	16	64	70	M16x1,5	50	G		M16x1,5	-	
1189229-01	-	2	M16x1,5	30HE	64	243	M16x1,5	250			M16x1,5	J	
1189229-04	-	2	M16x1,5	30HE	64	70	M16x1,5	50	G		M16x1,5	-	
1189229-05	-	2	M16x1,5	30HE	64	215	M16x1,5	50	G		M16x1,5	-	
1189490	-	3	1/4" NPTF	36	75	78	M16x1,5	50	G		5/8" UNF	J	
30010077/A	-	4	1/4" NPTF	24	75	210	5/8" UNF	193			5/8" UNF	J	K
K045276N00	BX3540	3	M16x1,5	24	57	200		180	G		M16x1,5	-	
K045254N00	BZ3324	5	M16x1,5	16	57	140	Ø12,0	-			M12x1,75	J	
K045266N00	BZ3332	6	M16x1,5	16	57	37		-	G		M16x1,5	-	

Brake Chambers (S Cam) – Diaphragm
Membranbremszylinder für S-Nockenbremse

Vases pour Frein à Came - Membrane
Elementi Frenanti (Camma a "S") – Membrana

Part Number	Type Number	Fig.	A	B	C [mm]	D [mm]	E	F [mm]	G	H	I	J	K
K045271N00	BZ3353	6	M16x1,5	16	57	37		–	G		M16x1,5	–	
K045255N00	BZ3438	7	M16x1,5	20	57	37	M14x1,5	50	G	M16x1,5		–	
K045256N00	BZ3439	7	M16x1,5	20	57	37	M14x1,5	50	G	M16x1,5		–	
K045260N00	BZ3441	8	M16x1,5	20	57	37		–	G		M16x1,5	–	
K045261N00	BZ3442	8	M16x1,5	20	57	37		–	G		M16x1,5	–	
K045262N00	BZ3443	8	M16x1,5	20	57	37		–	G		M16x1,5	–	
K045263N00	BZ3444	7	M16x1,5	20	57	37		–	G	M16x1,5		–	
K045264N00	BZ3464	8	M16x1,5	20	57	37		–	G		M16x1,5	–	
K045267N00	BZ3473	8	M16x1,5	20	57	37		–	G		M16x1,5	–	
K045268N00	BZ3480	8	M16x1,5	20	57	37		–	G		M16x1,5	–	
K045269N00	BZ3481	8	M16x1,5	20	57	37		–	G		M16x1,5	–	
K045275N00	BZ3490	8	M16x1,5	20	57	37	M14x1,5	50	G		M16x1,5	–	
K045274N00	BZ3491	8	M16x1,5	20	57	37	M14x1,5	50	G		M16x1,5	–	
K045257N00	BZ3537	7	M16x1,5	24	57	37	M14x1,5	50	G	M16x1,5		–	
K045258N00	BZ3538	7	M16x1,5	24	57	37	M14x1,5	50	G	M16x1,5		–	
K045265N00	BZ3555	8	M16x1,5	24	57	37		–	G		M16x1,5	–	
K045270N00	BZ3573	8	M16x1,5	24	57	37		–	G		M16x1,5	–	
K045272N00	BZ3588	8	M16x1,5	24	57	95		–	G		M16x1,5	–	
K045273N00	BZ3589	8	M16x1,5	24	57	75		–	G		M16x1,5	–	

31 (31.2)

Brake Chambers (S Cam) – Piston
Kolbenbremszylinder für S-Nockenbremse

Vases pour Frein à Came – Piston
Elementi Frenanti (Camma a "S") – Stantuffo

Legend	Legende	Légende	Legenda
A Port size	Anschlussgewinde	Raccord	Raccordi
B Piston Ø	Kolben Ø	Ø de piston	Ø Stantuffo
C Stroke	Hub	Course	Corsa
D Push rod length	Kolbenstangenlänge	Longueur de la tige	Lunghezza asta di spinta



Part Number	Type Number	Fig.	A	B [mm]	C [mm]	D [mm]
1053222000	–		M16x1,5	102	120	31
1053223000	–		M16x1,5	127	120	31

Brake Chambers (Wedge) – Thread Mounted

Vases pour Frein à Coin – Vissé

Membranbremszylinder für Keilspitzbremse, mit Gewindebefestigung

Elementi Frenanti (Freni a Cuneo) – Con Canotto

Legend		Legende	Légende	Legenda
A	Port size	Anschlussgewinde	Raccord	Raccordi
B	Type	Art	Type	Tipo
C	Piston Ø	Kolben Ø	Ø de piston	Ø Stantuffo
D	Stroke	Hub	Course	Corsa
E	Tube length (measured to centre line of air port)	Tragrohrlänge (gemessen bis Mitte Luftanschluss)	Longueur du tube (mesurée de l'extrémité aux orifices)	Lunghezza del canotto (misurata dall'estremità del raccordo)
F	Tube thread	Tragrohrgewinde	Filetage du tube	Filettatura del canotto

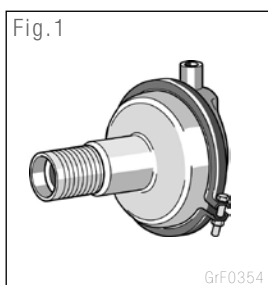

Part Number	Type Number	Fig.	A	B	C [mm]	D [mm]	E [mm]	F
EF90YE	–	1	M16x1,5	9	–	50	138	M48x2,0
EF90YES	–	1	M16x1,5	9	–	50	139	M48x2,0
EF105BY	–	1	M16x1,5	10,5	–	53	167	M48x2,0
EF105FY	–	1	M16x1,5	10,5	–	50	187	M48x2,0
EF120BY	–	1	M16x1,5	12	–	50	152	M48x2,0
EF120C	–	1	M16x1,5	12	–	50	318	1,75" – 12 UNF
EF120FY	–	1	M16x1,5	12	–	50	187	M48x2,0
EF120L	–	1	M16x1,5	12	–	50	157	1,75" – 12 UNF
EF120P	–	1	M16x1,5	12	–	50	138	M48x2,0
EF120YES	–	1	M16x1,5	12	–	50	139	M48x2,0
EF141AY	–	1	M16x1,5	14	–	53	152	M48x2,0
EF141FY	–	1	M16x1,5	14	–	53	187	M48x2,0
EF141NYX	–	1	M16x1,5	14	–	53	152	M48x2,0
EF141PYX	–	1	M16x1,5	14	–	53	187	1,75" – 12 UNS
EF161AY	–	1	M16x1,5	16	–	53	152	M48x2,0
EF161DY	–	1	M16x1,5	16	–	53	162	M48x2,0
EF161DYX	–	1	M16x1,5	16	–	53	162	M48x2,0
EF161FY	–	1	M16x1,5	16	–	53	187	M48x2,0
EF161NYX	–	1	M16x1,5	16	–	53	152	M48x2,0
EF161PYX	–	1	M16x1,5	16	–	53	190	M48x2,0
EF180BY	–	1	M16x1,5	18	–	53	180	M48x2,0
EF180FY	–	1	M16x1,5	18	–	53	187	M48x2,0
EF180NYX	–	1	M16x1,5	18	–	53	152	M48x2,0
EF180PYX	–	1	M16x1,5	18	–	53	190	M48x2,0
EF201BY	–	1	M16x1,5	20	–	53	180	M48x2,0
EF201LA	–	1	M16x1,5	20	–	53	247	M45x1,5

31 (31.3)

Brake Chambers (Wedge) – Thread Mounted

Membranbremszylinder für Keilspreibremse, mit Gewindebefestigung

Vases pour Frein à Coin – Vissé

Elementi Frenanti (Freni a Cuneo) – Con Canotto

Part Number	Type Number	Fig.	A	B	C [mm]	D [mm]	E [mm]	F
EF201LY	–	1	M16x1,5	20	–	53	230	M48x2,0
EF221LY	–	1	M16x1,5	22	–	53	230	M48x2,0
EF241BY	–	1	M16x1,5	24	–	53	180	M48x2,0
EF241LY	–	1	M16x1,5	24	–	53	245	M48x2,0
EF241MY	–	1	M16x1,5	24	–	53	275	M48x2,0
EF241QA	–	1	M16x1,5	24	–	53	268	M45x1,5
K029374N00	–	1	M16x1,5	10,5	–	50	152	M48x2,0
K032483N00	–	1	M16x1,5	10,5	–	53	152	M48x2,0
K041984N00	–	1	M16x1,5	18	–	53	244	M45x1,5
I86291	BY3303	1	M16x1,5	18	–	50	215	1,75" – 12 UNS
K004330	BY3359	1	M16x1,5	18	–	53	245	M48x2,0
II37730	BY3406	1	M16x1,5	20	–	53	194	M45x2,0
II39666F	BY3408	1	M16x1,5	20	–	53	247	M45x2,0
II37731	BY3509	1	M16x1,5	24	–	53	194	M45x2,0
K002171	BY3510	1	M16x1,5	24	–	53	247	M45x2,0
I78042	BZ3117	1	M16x1,5	9	–	44,5	215	1,75" – 12 UNS
I88827	BZ3253	1	M16x1,5	12	–	44,5	206	1,75" – 12 UNS

Brake Chambers (Wedge) - Flange Mounted
 Membranbremszylinder für Keilspreibremse, mit Flanschbefestigung

Vases pour Frein à Coin – Bride
 Elementi Frenanti (Freni a Cuneo) - Flangiati

Legend	Legende	Légende	Legenda
A	Port size	Anschlussgewinde	Raccord
A ₁	Radial port	Anschluss mittig	Raccordement radiale
A ₂	Central port	Anschluss seitlich	Raccordement centrale
B	Type	Art	Tipo
C	Stroke	Hub	Course
D	Tube length (measured to centre line of air port)	Tragrohrlänge (gemessen bis Mitte Luftanschluss)	Longueur du tube (mesurée de l'extrémité à l'orifice)
			Lunghezza del canotto (misurata dall'estremità del raccordo)



Part Number	Type Number	Fig.	A ₁	A ₂	B	C [mm]	D [mm]
0482023504000	–	1	M22x1,5	M12x1,5	14	53	200
0482023610000	–	1	M22x1,5	M12x1,5	16	53	200
0482023708170	–	1	M22x1,5	M12x1,5	18	53	200
0482023809170	–	1	M22x1,5		20	53	253
0482023810170	–	1	M22x1,5		20	53	253
0482023907170	–	1	M22x1,5		22	53	253
0482023925170	–	1	M22x1,5		24	53	253
0482023926170	–	1	M22x1,5		24	53	253
0482023927000	–	1	M22x1,5	M12x1,5	24	53	200

31 (31.5)

Brake Chambers (Disc) Membranbremszylinder für Scheibenbremse

Vases à Diaphragme (Disque) Elementi Frenanti (Disco)

Legend		Legende	Légende	Legenda
A	Port size	Anschlussgewinde	Raccord	Raccordi
A ₁	Radial port	Anschluss seitlich	Raccordement radiale	Ingresso radiale
A ₂	Central port	Anschluss mittig	Raccordement centrale	Ingresso centrale
B	Type	Art	Type	Tipo
C	Stroke	Hub	Course	Corsa
D	Push rod protrusion	Vorstehmaß Kolbenstange	Dépassement du poussoir	Sporgenza asta di spinta
E	Mounting nuts fitted	Mit Befestigungsmuttern	Equipée d'écrous de montage	Con dadi di fissaggio
F	Symmetrical to	Symmetrisch zu	Symétrique a	Simmetrico a
P	Plugged	Eingesteckt	Bouché	Tappato

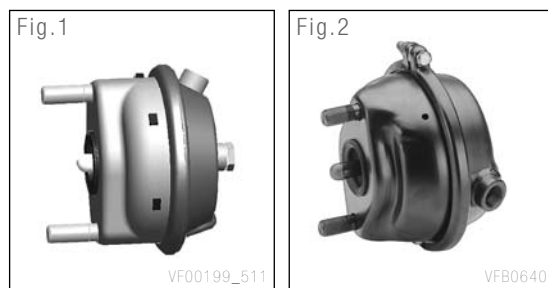

Part Number	Type Number	Fig.	A ₁	A ₂	B	C [mm]	D [mm]	E	F
K006510N00	BS2306	1	M16x1,5	M16x1,5	16	57	15	–	
K006511N00	BS2307	1	M16x1,5	M16x1,5	16	57	15	–	
K031601N00	BS2323	1	M16x1,5	M16x1,5 (P)	16	57	15	–	
K017984	BS2402	1	M16x1,5		20	57	15	–	BS2408
K017982	BS2406	1	M22x1,5		20	64	15	–	BS2407
K017983	BS2407	1	M22x1,5		20	64	15	–	BS2406
K017985	BS2408	1	M16x1,5		20	57	15	–	BS2402
K018199	BS2409	1	M22x1,5 Voss		20	64	15	–	BS2410
K018200	BS2410	1	M22x1,5 Voss		20	64	15	–	BS2409
K006648N00	BS2429	1	M16x1,5	M16x1,5	20	57	15	–	
K006649N00	BS2430	1	M16x1,5	M16x1,5	20	57	15	–	
K007799	BS2437	1	M22x1,5		20	57	15	–	
K010666	BS2443	2	M16x1,5		20	57	15	–	
K006490N00	BS2503	1	M16x1,5		24	57	15	–	
K002556	BS2504	2	M16x1,5	M16x1,5	24	64	15	–	
K002843	BS2514	1	M22x1,5		24	64	15	–	BS2515
K002844	BS2515	1	M22x1,5		24	64	15	–	BS2514
K006655N00	BS2523	2	M16x1,5	M16x1,5	24	57	15	–	BS2524
K006656N00	BS2524	2	M16x1,5	M16x1,5	24	57	15	–	BS2523
K016480	BS2546	2	M22x1,5		24	64	15	–	BS2547
K016481	BS2547	2	M22x1,5		24	64	15	–	BS2546
K006339	BS3155	2	M16x1,5		10	57	15	–	

Brake Chambers (Disc)
Membranbremszylinder für Scheibenbremse

Vases à Diaphragme (Disque)
Elementi Frenanti (Disco)

Part Number	Type Number	Fig.	A ₁	A ₂	B	C [mm]	D [mm]	E	F
K008766	BS3201	2	M16x1,5	M16x1,5	12	57	15	–	
K008768	BS3207	2	M16x1,5	M16x1,5	12	57	15	–	
K006506N00	BS3212	1	M16x1,5	M16x1,5	12	57	15	–	BS3213
K006507N00	BS3213	1	M16x1,5	M16x1,5	12	57	15	–	BS3212
K003968N00	BS3250	2	M22x1,5 Voss		14	57	15	–	
II31782	BS3251	2	M16x1,5		14	57	15	–	
K010290	BS3269	2	M16x1,5	M16x1,5	14	57	15	–	
K004286N00	BS3273	1	M22x1,5 Voss		14	57	15	–	
K004737N00	BS3281	2	M16x1,5		14	57	15	–	
K019133	BS3294	1	M16x1,5		14	57	15	–	
K028079N00	BS3296	2	M16x1,5		14	57	15	–	BS3297
K028080N00	BS3297	2	M16x1,5		14	57	15	–	BS3296
K029440N00	BS3298	1	M16x1,5		14	57	15	–	BS3299
K029441N00	BS3299	1	M16x1,5		14	57	15	–	BS3298
II14535	BS3300	2	M16x1,5		16	57	15	–	
K004146N00	BS3301	1	M22x1,5 Voss		16	57	15	–	
K003840	BS3313	2	M16x1,5	M16x1,5	16	57	15	–	
II37140000	BS3315	2		M16x1,5	16	57	15	–	
K015579	BS3316	2	M16x1,5		16	57	15	–	
K015580	BS3317	2	M16x1,5		16	57	15	–	
II38111F	BS3321	2	M16x1,5		16	57	15	–	
II38466F	BS3326	2		M16x1,5	16	57	15	–	
K003841	BS3332	2	M16x1,5	M16x1,5	16	57	15	–	
II39218F	BS3335	2	M22x1,5		16	75	20	–	
II39374F	BS3336	2	M22x1,5		16	75	20	–	
II39375F	BS3337	2	M22x1,5		16	75	20	–	
II15229	BS3350	2	M16x1,5		18	57	15	–	
K003030	BS3354	2	M16x1,5	M16x1,5	18	64	15	–	
II38527F	BS3358	2		M16x1,5	18	57	15	–	
K003031	BS3362	2	M16x1,5	M16x1,5	18	64	15	–	
K028697N00	BS3379	1	M16x1,5		18	57	15	–	
K004171N00	BS3401	1	M22x1,5 Voss	M12x1,5	20	64	15	–	
K005086	BS3402	1	M16x1,5		20	64	15	–	BS3403
K005087	BS3403	1	M16x1,5		20	64	15	–	BS3402
II31098	BS3404	2	M16x1,5		20	57	15	–	
K004172N00	BS3409	1	M22x1,5 Voss	M12x1,5	20	64	15	–	BS3410
K004207N00	BS3410	1	M22x1,5 Voss	M12x1,5	20	64	15	–	BS3409
K004209N00	BS3411	1	M22x1,5 Voss	M12x1,5	20	64	15	–	BS3412
K004211N00	BS3412	1	M22x1,5 Voss	M12x1,5	20	64	15	–	BS3411
K003994N00	BS3413	2	M22x1,5 Voss	M12x1,5	20	61	15	–	BS3414
K003995N00	BS3414	2	M22x1,5 Voss	M12x1,5	20	61	15	–	BS3413
II32710	BS3415	2	M16x1,5	M16x1,5	20	64	15	–	

Part Number	Type Number	Fig.	A ₁	A ₂	B	C [mm]	D [mm]	E	F
K003020	BS3423	2	M16x1,5	M16x1,5	20	64	15	–	
K004485N00	BS3434	2	M22x1,5 Voss	M12x1,5	20	64	15	–	BS3435
K004486N00	BS3435	2	M22x1,5 Voss	M12x1,5	20	64	15	–	BS3434
II38528F	BS3436	2		M16x1,5	20	57	15	–	
K005814	BS3436	1		M16x1,5	20	57	15	–	
K003021	BS3441	2	M16x1,5	M16x1,5	20	64	15	–	
II14540	BS3450	2	M16x1,5		22	65	15	–	
II18850	BS3451	2	M16x1,5		22	65	15	–	BS3452
II18886	BS3452	2	M16x1,5		22	65	15	–	BS3451
II31099	BS3453	2	M16x1,5		22	57	15	–	
K003012	BS3458	2	M16x1,5	M16x1,5	22	64	15	–	
II38529F	BS3462	2		M16x1,5	22	57	15	–	
K003013	BS3467	2	M16x1,5	M16x1,5	22	64	15	–	
K001214	BS3471	2	M16x1,5		22	57	15	–	BS3472
K001215	BS3472	2	M16x1,5		22	57	15	–	BS3471
K006653N00	BS3474	2	M16x1,5	M16x1,5	22	64	15	–	BS3475
K006654N00	BS3475	2	M16x1,5	M16x1,5	22	64	15	–	BS3474
K002623N00	BS3501	2	M22x1,5 Voss	M12x1,5	24	64	15	–	
K015585	BS3507	2	M16x1,5		24	57	15	–	BS3511
K018266	BS3507	1	M16x1,5		24	57	15	–	BS3511
K015586	BS3511	2	M16x1,5		24	57	15	–	BS3507
K018267	BS3511	1	M16x1,5		24	57	15	–	BS3507
K002624N00	BS3514	1	M22x1,5 Voss	M12x1,5	24	64	15	–	BS3515
K003996N00	BS3514	2	M22x1,5 Voss	M12x1,5	24	64	15	–	BS3515
K002720N00	BS3515	1	M22x1,5 Voss	M12x1,5	24	64	15	–	BS3514
K003997N00	BS3515	2	M22x1,5 Voss	M12x1,5	24	64	15	–	BS3514
K002721N00	BS3516	1	M22x1,5 Voss	M12x1,5	24	64	15	–	BS3522
K005211	BS3516	1	M22x1,5 Voss	M12x1,5	24	64	15	–	BS3522
K017944	BS3521	1	M16x1,5		24	57	15	–	BS3520
K002722N00	BS3522	1	M22x1,5 Voss	M12x1,5	24	64	15	–	BS3516
K005212	BS3522	1	M22x1,5 Voss	M12x1,5	24	64	15	–	BS3516
K015591	BS3526	2	M22x1,5		24	75	26	–	BS3528
K015592	BS3528	2	M22x1,5		24	75	26	–	BS3526
K002420	BS3532	2	M16x1,5	M16x1,5	24	64	15	–	
K015589	BS3536	2	M22x1,5		24	75	20	–	BS3537
K015590	BS3537	2	M22x1,5		24	75	20	–	BS3536
II37127	BS3538	2	M16x1,5		24	65	15	–	
K003170	BS3538	1	M16x1,5		24	65	15	–	
K005817	BS3547	1		M16x1,5	24	57	15	–	
K015833	BS3800	2	M16x1,5		20	57	15	–	BS3801
K017986	BS3800	1	M16x1,5		20	57	15	–	BS3801
K015834	BS3801	2	M16x1,5		20	57	15	–	BS3800

Brake Chambers (Disc)
Membranbremszylinder für Scheibenbremse

Vases à Diaphragme (Disque)
Elementi Frenanti (Disco)

Part Number	Type Number	Fig.	A ₁	A ₂	B	C [mm]	D [mm]	E	F
K017987	BS3801	1	M16x1,5		20	57	15	–	BS3800
K017988	BS3806	1	M16x1,5		20	57	15	–	
K025367	BS3810	2	M22x1,5		20	64	15	–	
K031597N00	BS3811	1	M16x1,5		20	57	15	–	BS3812
K031598N00	BS3812	1	M16x1,5		20	57	15	–	BS3811
K028614N00	BS4502	1		M16x1,5	24	64	15	–	
K031532N00	BS4503	1	M16x1,5		24	57	15	–	BS4504
K031533N00	BS4504	1	M16x1,5		24	57	15	–	BS4503

31 (31.6)

Brake Chamber (Air/Hyd) – Diaphragm
Vorspannzylinder – Membran

Vases à Membrane AIR/HYD
Convertitori Pneumoidraulici – Membrana

Legend	Legende	Légende	Legenda
A Port size	Anschlussgewinde	Raccord	Raccordi
B Type	Art	Type	Tipo
C Stroke	Hub	Course	Corsa
D Complete with master cylinder	Mit Hauptzylinder	Complet avec maître cylindre	Completo di cilindro maestro

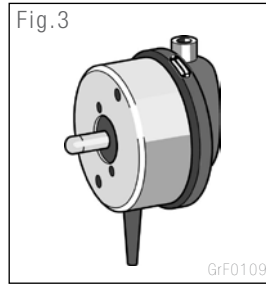
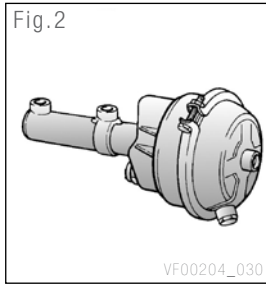
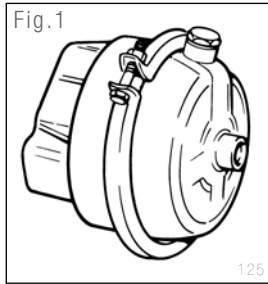

Part Number	Type Number	Fig.	A	B	C [mm]	D
K003833	–	1	M16x1,5	16	75	–
K021211N00	–	2	M16x1,5	24	50	D
I76260	BZ3645	3	M16x1,5	30	75	–
I76261	BZ3713	3	M16x1,5	30	75	–
I88263	BZ5410	3	M16x1,6	20	75	–
II40329F	STK5382	1	M22x1,5 Voss	30	75	–

	Page
32.1 Spring Brakes (S Cam) – Diaphragm / Piston	138
32.2 Spring Brakes (S Cam) – Piston / Piston	140
32.3 Spring Brakes (S Cam) – Diaphragm / Diaphragm	141
32.4 Spring Brakes (Wedge) – Thread Mounted	142
32.5 Spring Brakes (Wedge) – Flange Mounted	144
32.6 Spring Brakes (Disc) – Diaphragm / Piston	145
32.7 Spring Brakes (Disc) – Diaphragm / Diaphragm	151

	Seite
32.1 Kombizylinder Membran / Kolben für S-Nockenbremse	138
32.2 Kombizylinder Kolben / Kolben für S-Nockenbremse	140
32.3 Kombizylinder Membran / Membran für S-Nockenbremse (Anhänger)	141
32.4 Kombizylinder für Keilspreibremse, mit Gewindebefestigung	142
32.5 Kombizylinder für Keilspreibremse, mit Flanschbefestigung	144
32.6 Kombizylinder Membran / Kolben für Scheibenbremse	145
32.7 Kombizylinder Membran / Membran für Scheibenbremse	151

	Page
32.1 Cylindres de Frein à Came – Membrane / Piston	138
32.2 Cylindres de Frein à Came – Piston / Piston	140
32.3 Cylindres de Frein à Came – Membrane / Membrane	141
32.4 Cylindres de Frein à Coin – Vissé	142
32.5 Cylindres de Frein à Coin – Bride	144
32.6 Cylindres Double (Disque) – Membrane / Piston	145
32.6 Cylindres Double (Disque) – Membrane / Membrane	151

	Pagina
32.1 Cilindri Doppi (Camma a “S”) – Membrana / Stantuffo	138
32.2 Cilindri Doppi (Camma a “S”) – Stantuffo / Stantuffo	140
32.3 Cilindri Doppi (Camma a “S”) – Membrana / Membrana	141
32.4 Cilindri Doppi (Freni a Cuneo) – Con Canotto	142
32.5 Cilindri Doppi (Freni a Cuneo) – Flangiati	144
32.6 Cilindri Doppi a Molla (Disco) – Membrana / Stantuffo	145
32.6 Cilindri Doppi a Molla (Disco) – Membrana / Membrana	151

32 (32.1)

Spring Brake (S Cam) – Diaphragm/Piston
Kombizylinder Membran/ Kolben für S-Nockenbremse

Cylindres de Frein à Came – Membrane / Piston
Cilindri Doppi (Camma a "S") – Membrana / Stantuffo

Legend	Legende	Légende	Legenda
A	Port size	Anschlussgewinde	Raccord
B	Type	Art	Typo
C	Spring portion rating	Federspeicherkraftabgabe	Effort frein de stationnement
D	Stroke of service portion/stroke of spring portion	Hub Betriebsbremsteil / Federspeicherteil	Course frein de service/frein de stationnement
E	Push rod length (to yoke pin centre if fitted)	Kolbenstangenlänge (gemessen Mitte Gabelkopfbohrung bis Flansch)	Longueur de la tige (à l'axe de chape)
F	Push rod	Kolbenstange	Tige
G	Push rod thread length	Gewindelänge	Longueur filettée de la tige
H	Yoke fitted	Gabelkopf montiert	Equipée de chape
I	Mounting studs	Stehbolzen	Goujons de montage
J	Mounting nuts fitted	Mit Befestigungsmuttern	Equipée d'écrous de montage
1)	incl. adaptors	inkl. Adapter	Adaptateurs inclus

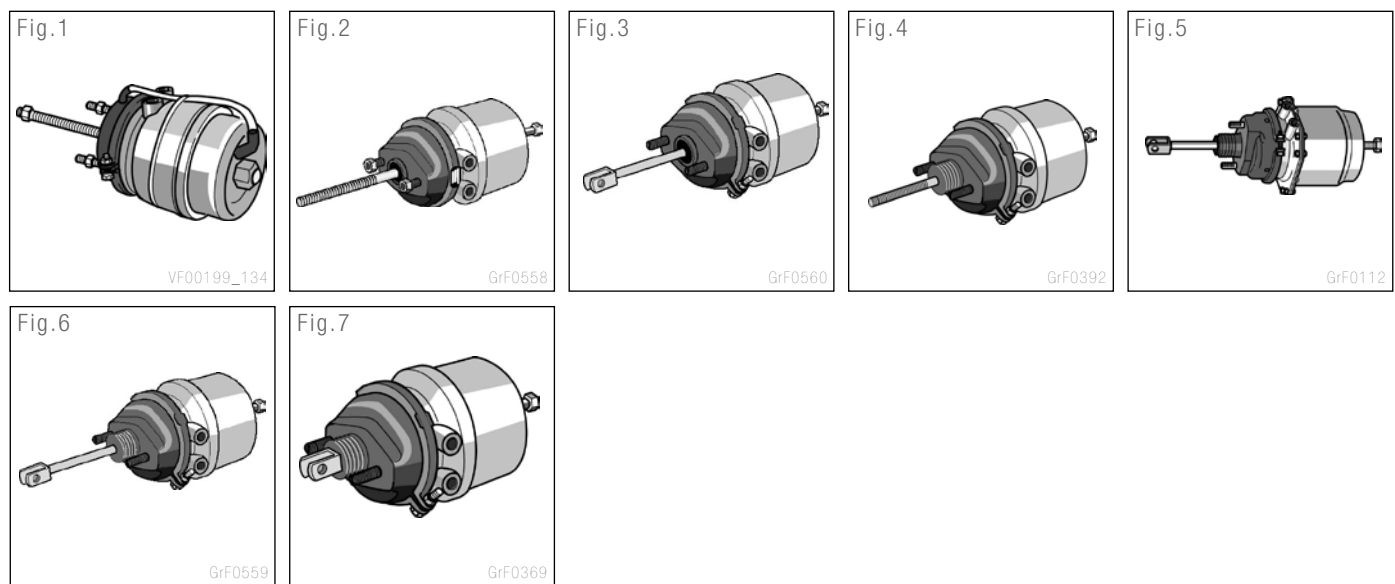

Part Number	Type Number	Fig.	A	B	C	D	E	F	G	H	I	J
					x100[N]	[mm]	[mm]		[mm]			
K2B0504X50	–	1	M16x1,5	20	80	64/64	250	M16x1,5	250		M16x1,5	J
K2B0506X50	–	1	M16x1,5	24	80	64/64	250	M16x1,5	250		M16x1,5	J
K2B0513X50	–	1	M16x1,5	24	98	64/64	250	M16x1,5	250		M16x1,5	J
K2B0514X50	–	1	M16x1,5	24	105	64/64	250	M16x1,5	250		M16x1,5	J
K2B0520X50	–	1	M16x1,5	30	80	64/64	250	M16x1,5	250		M16x1,5	J
K2B0521X50	–	1	M16x1,5	30	98	64/64	250	M16x1,5	250		M16x1,5	J
K2B0522X50	–	1	M16x1,5	30	105	64/64	250	M16x1,5	250		M16x1,5	J
K2B0528X50	–	1	3/8" NPTF ¹⁾	24	80	64/64	250	5/8" UNF	250		M16x1,5	J

Part Number	Type Number	Fig.	A	B	C x100[N]	D [mm]	E [mm]	F	G [mm]	H	I	J
K2B0543X50	–	1	3/8" NPTF ¹⁾	30	98	64/64	250	5/8"UNF	250		M16x1,5	J
K2B1034VE	–	1	M16x1,5	24	105	64/64	58	M16x1,5	50		M16x1,5	–
K2B1035VE	–	1	M16x1,5	24	105	64/64	58	M16x1,5	50		M16x1,5	–
K2B1101X50	–	1	M16x1,5	30	98	64/64	40	5/8"UNF	50		M16x1,5	J
K2B1164VE	–	1	M16x1,5	24	80	64/64	58	M16x1,5	50		M16x1,5	–
K2B1193	–	1	M16x1,5	24	80	64/64	268	M16x1,5	50	H	M16x1,5	–
K2C2004X50	–	1	3/8" NPTF ¹⁾	30	80	57/57	168	5/8"UNF	135		M16x1,5	J
K2D3012	–	1	M16x1,5	20	105	64/64	70	M16x1,5	50	H	M16x1,5	–
K2D3013	–	1	M16x1,5	20	105	64/64	184	M16x1,5	50	H	M16x1,5	–
K2D3014	–	1	M16x1,5	20	105	64/64	184	M16x1,5	50	H	M16x1,5	–
II37274	BX9400	2	M22x1,5 Voss ¹⁾	20/24	102	57/57	300	M16x1,5	300	H	M16x1,5	J
II31409	BX9500	3	M16x1,5	24/24	102	57/57	86	M16x1,5	86	H	M16x1,5	–
K002607	BX9551	4	M22x1,5 Voss ¹⁾	24/24	102	57/57	300	M16x1,5	300	H	M16x1,5	J
K002609	BX9553	4	M22x1,5 Voss ¹⁾	24/30	131	57/57	300	M16x1,5	300	H	M16x1,5	J
II14008	BZ7564	5	M16x1,5	24	45,8	57/57	37		–	H	M16x1,5	–
II14009	BZ7567	5	M16x1,5	24	45,8	57/57	37		–	H	M16x1,5	–
II31997	BZ9317	4	M16x1,5	16/24	102	57/57	300	M16x1,5	300	H	M16x1,5	J
II38131F	BZ9330	6	M16x1,5	16/24	105	57/57	190		–	H	M16x1,5	–
II16854000	BZ9404	3	M16x1,5 Voss	20/24	102	57/57	300		–	H	M16x1,5	–
II16855000	BZ9405	3	M16x1,5 Voss	20/24	102	57/57	86		–	H	M16x1,5	–
II16852	BZ9406	7	M16x1,5	20/24HF	110	57/57	75		–	H	M16x1,5	–
II19342000	BZ9417	3	M16x1,5	20/24	110	57/57	260		–	H	M16x1,5	–
II32006	BZ9424	7	M22x1,5 Voss	20/24HF	118	57/57	58		–	H	M16x1,5	–
II14560000	BZ9425	7	M22x1,5 Voss	20/30	130	57/57	37		–	H	M16x1,5	–
II33675000	BZ9447	3	M16x1,5	20/24	110	57/57	70		–	H	M16x1,5	–
II17092	BZ9502	4	M16x1,5	24/24HF	118	57/57	75		–	H	M16x1,5	–
II17479	BZ9506	3	M16x1,5	24/24HF	118	64/64	265		–	H	M16x1,5	J
II19020000	BZ9510	3	M16x1,5 Voss	24/24	102	5757	260		–	H	M16x1,5	–
II19264	BZ9512	6	M22x1,5 Voss	24/24HF	118	5757	75		–	H	M16x1,5	–
II19265	BZ9513	7	M22x1,5 Voss	24/24HF	118	5757	200		–	H	M16x1,5	–
II19266	BZ9514	6	M22x1,5 Voss	24/24HF	118	5757	200		–	H	M16x1,5	–
II30079	BZ9529	6	M22x1,5 Voss	24/30	130	57/57	75		–	H	M16x1,5	–
II18971000	BZ9553	3	M16x1,5	27/24	102	64/64	70		–	H	M16x1,5	–
II18972000	BZ9554	3	M16x1,5	27/24	102	64/64	86		–	H	M16x1,5	–
II40321F	BZ9566	4	M22x1,5 Voss	27/30	130	64/64	300	M16x1,5	265	H	M16x1,5	J
II19748	BZ9630	6	M16x1,5	30/30	130	64/64	318		–	H	M16x1,5	–
II31091	BZ9644	3	M16x1,5	30/30	130	64/64	86	M16x1,5	–	H	M16x1,5	–
II31104	BZ9645	4	M16x1,5	30/30	130	64/64	300	M16x1,5	300		M16x1,5	–
II32128	BZ9646	4	M16x1,5	30/30	130	64/64	300	M16x1,5	300		M16x1,5	J
K041990N00	BZ9646	4	M16x1,5	30/30	130	64/64	300	M16x1,5	300	H	M16x1,5	–
K010937	BZ9664	2	M22x1,5 Voss	30/30	130	64/64	33	M16x1,5	33		M16x1,5	–

32 (32.2)

Spring Brake (S Cam) – Piston / Piston
Kombizylinder Kolben/ Kolben für S-Nockenbremse

Cylindres de Frein à Came – Piston / Piston
Cilindri Doppri (Camma a "S") – Stantuffo / Stantuffo

Legend	Legende	Légende	Legenda
A	Port sizes	Anschlussgewinde	Raccord
B	Piston Ø	Kolben Ø	Ø de piston
C	Spring portion rating	Federspeicherkraftabgabe	Effort frein de stationnement
D	Stroke of service portion/stroke of spring portion	Hub Betriebsbremsteil / Federspeicherteil	Course frein de service/frein de stationnement
E	Push rod length (to yoke pin centre if fitted)	Kolbenstangenlänge (gemessen Mitte Gabelkopfbohrung bis Flansch/Befestigungsbohrungen)	Longueur de la tige (à l'axe de chape)
F	Flange mounted	Flanschbefestigung	Fixation par flasque

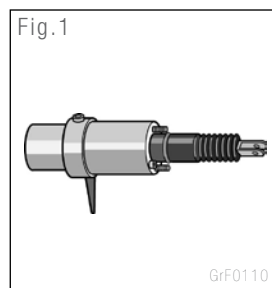

Part Number	Type Number	Fig.	A	B	C x100[N]	D [mm]	E [mm]	F
I82454	BZ6427	1	M16x1,5	100/150	80	80/80	170	F

Spring Brakes (S Cam) – Diaphragm / Diaphragm
Kombizylinder Membran/Membran für S-Nockenbremse (Anhänger)

Cylindres de Frein à Came – Membrane / Membrane
Cilindri Doppi (Camma a "S") – Membrana / Membrana

Legend	Legende	Légende	Legenda
A Port size	Anschlussgewinde	Raccord	Raccordi
B Type	Art	Type	Tipo
C Stroke of service portion/stroke of spring portion	Hub Betriebsbremsteil / Federspeicherteil	Course frein de service/frein de stationnement	Corsa freno di servizio / freno di stazionamento
D Push rod length (to yoke pin centre if fitted)	Kolbenstangenlänge (gemessen Mitte Gabelkopfbohrung bis Flansch)	Longueur de la tige (à l'axe de chape)	Lunghezza asta di spinta (dal centro della leva se montata)
E Push rod	Kolbenstange	Tige	Asta di spinta
F Push rod thread length	Gewindelänge	Longueur filettée de la tige	Lunghezza filettatura asta di spinta
G Yoke fitted	Gabelkopf montiert	Equipée de chape	Forcella muniti
H Mounting studs	Stehbolzen	Goujons de montage	Bulloni
I Mounting nuts fitted	Mit Befestigungsmuttern	Equipée d'écrous de montage	Con dadi di fissaggio

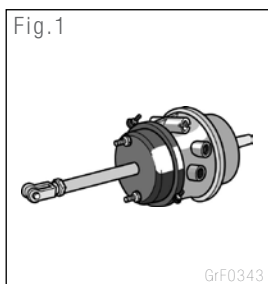

Part Number	Type Number	Fig.	A	B	C [mm]	D [mm]	E	F [mm]	G	H	I
K012501N00	–	1	M16x1,5	24/30	75/75	148	M16x1,5	113	G	M16x1,5	I
K012502N00	–	1	M16x1,5	24/30	75/75	148	M16x1,5	113	G	M16x1,5	I
K031736N00	BX7401	1	M16x1,5	20/24	57/57	285	M16x1,5	242	G	M16x1,5	I
K031737N00	BX7402	1	M16x1,5	20/24	57/57	227	M16x1,5	184	G	M16x1,5	I
K037983N00	BX7414	1	M16x1,5	20/24	57/57	288	M16x1,5	245	G	M16x1,5	I
K031748N00	BX7514	1	M16x1,5	24/30	57/57	250	M16x1,5	207	G	M16x1,5	I
K037970N00	BX7515	1	M16x1,5	24/30	75/75	250	M16x1,5	207	G	M16x1,5	I
K031738N00	BX7516	1	M16x1,5	24/24	57/57	280	M16x1,5	237	G	M16x1,5	I
K031739N00	BX7523	1	M16x1,5	24/30	75/75	250	M16x1,5	207	G	M16x1,5	I
K031740N00	BX7525	1	M16x1,5	24/30	75/75	227	M16x1,5	184	G	M16x1,5	I
K037810N00	BX7542	1	M16x1,5	24/30	75/75	259	M16x1,5	216	G	M16x1,5	I
K038535N00	BX7543	1	M16x1,5	24/30	64/64	258	M16x1,5	215	G	M16x1,5	I
K038537N00	BX7545	1	M16x1,5	24/24	64/64	288	M16x1,5	245	G	M16x1,5	I
K031744N00	BX7611	1	M16x1,5	30/30	64/64	280	M16x1,5	237	G	M16x1,5	I
K031745N00	BX7612	1	M16x1,5	30/30	64/64	227	M16x1,5	184	G	M16x1,5	I
K038538N00	BX7618	1	M16x1,5	30/30	64/64	288	M16x1,5	245	G	M16x1,5	I

Legend	Legende	Légende	Legenda
A	Port size	Anschlussgewinde	Raccord
B	Type	Art	Typo
C	Spring portion rating	Federspeicherkraftabgabe	Effort frein de stationnement
D	Stroke of service portion/ stroke of spring portion	Hub Betriebsbremsteil / Federspeicherteil	Course frein de service/frein de stationnement
E	Tube length (measured to centre line of air port)	Tragrohrlänge (gemessen bis Mitte Luftanschluss)	Longueur du tube (Mesurée de l'extrémité aux orifices)
F	Tube thread	Tragrohrgewinde	Filetage du tube

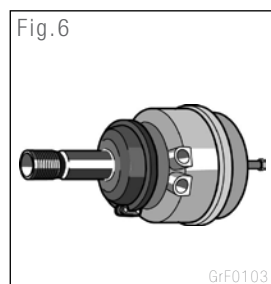
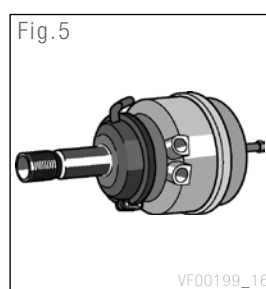
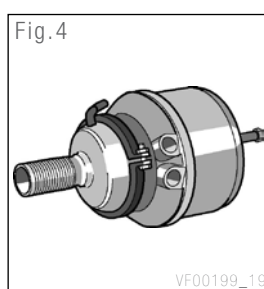
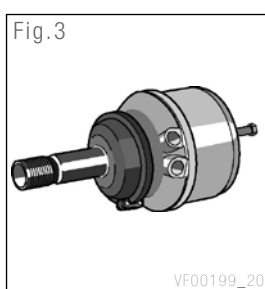
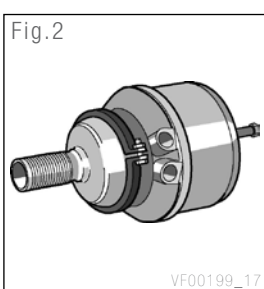
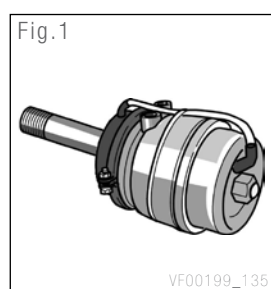

Part Number	Type Number	Fig.	A	B	C x100[N]	D [mm]	E [mm]	F
K2E4002X50	–	1	M16x1,5	9-47	47	50/50	186	M48x2,0
II17468	BY9205	2	M16x1,5	12/20	97,6	53/53	180	M48x2,0
II39595F	BY9230	3	M16x1,5	12/20HF	100	53/53	207	M48x2,0
K003845000	BY9233	3	M16x1,5	12/20		53/53	187	1,75" – 12 UNS
K003847000	BY9235	3	M16x1,5	12/20		53/53	160	1,75" – 12 UNS
K003865000	BY9236	3	M16x1,5	12/20HF		53/53	187	1,75" – 12 UNS
K003868000	BY9237	2	M16x1,5	12/20		53/53	160	1,75" – 12 UNS
K003869000	BY9238	3	M16x1,5	12/16		53/53	187	1,75" – 12 UNS
K004077	BY9239	2	M16x1,5	12/20	87	53/53	180	M48x2,0
II19750	BY9260	2	M16x1,5	14/24HF	108	53/53	190	M48x2,0
II39358F	BY9272	2	M16x1,5	14/24HFL3	125	53/53	190	M48x2,0
K001057	BY9276	2	M16x1,5	14/24HFL3		53/53	190	M48x2,0
K014029	BY9278	4	M16x1,5	16/24HF	108	53/53	190	M48x2,0
K014031	BY9279	4	M16x1,5	16/24HFL3		50/50	190	M48x2,0
K031711N00	BY9287	5	M16x1,5	14/20		53/53	180	M48x2,0
K014027000	BY9300	2	M16x1,5	16/24HF	108	53/53	190	M48x2,0

Part Number	Type Number	Fig.	A	B	C x100[N]	D [mm]	E [mm]	F
K014028000	BY9303	2	M16x1,5	16/24HF	108	53/53	190	M48x2,0
K014026000	BY9305	2	M16x1,5	16/20	97,6	53/53	180	M48x2,0
K014032	BY9328	2	M16x1,5	16/24HFL3		53/53	190	M48x2,0
K014030	BY9331	2	M16x1,5	16/24HFL3		53/53	190	M48x2,0
K001715	BY9367	4	M16x1,5	18/24HF	108	53/53	190	M48x2,0
K003924	BY9368	4	M16x1,5	18/24HF	108	53/53	245	M48x2,0
K011981	BY9369	2	M16x1,5	18/20	94	53/53	220	M48x2,0
K011981	BY9369	6	M16x1,5	18/20	94	53/53	220	M48x2,0
K011996	BY9370	6	M16x1,5	16/20	94	53/53	180	M48x2,0
K011996	BY9370	2	M16x1,5	16/20	94	53/53	180	M48x2,0
K011997	BY9371	2	M16x1,5	16/20	94	53/53	220	M48x2,0
K011997	BY9371	6	M16x1,5	16/20	94	53/53	220	M48x2,0
K012717	BY9372	6	M16x1,5	18/20	94	53/53	180	M48x2,0
II32135	BY9408	2	M16x1,5	20/24	102	53/53	245	M48x2,0
II37312	BY9411	2	M16x1,5	20/24	102	53/53	194	M45x1,5
II37313	BY9412	2	M16x1,5	20/24	102	53/53	224	M45x1,5
II17755	BY9451	2	M16x1,5	22/24HF	108	53/53	190	M48x2,0
II18692	BY9452	4	M16x1,5	22/24HF	108	53/53	190	M48x2,0
K016929	BY9452	4	M16x1,5	22/24HF	108	53/53	190	M48x2,0
II17756	BY9501	2	M16x1,5	24/24HF	108	53/53	190	M48x2,0
II18691	BY9504	4	M16x1,5	24/24HF	108	53/53	245	M48x2,0
II34017	BY9505	2	M16x1,5	24/24	102	53/53	247	M45x1,5
II37145	BY9506	2	M16x1,5	24/24	102	53/53	194	M45x1,5
K002163	BY9512	2	M16x1,5	24/24	102	53/53	224	M45x1,5

Legend	Legende	Légende	Legenda
A	Port size	Anschlussgewinde	Raccord
B	Type	Art	Tipo
C	Spring portion rating	Federspeicherkraftabgabe	Effort frein de stationnement
D	Stroke of service portion/ stroke of spring portion	Hub Betriebsbremsteil / Federspeicherteil	Course frein de service/frein de stationnement
E	Tube length (measured to centre line of air port)	Tragrohrlänge (gemessen bis Mitte Luftanschluss)	Longueur du tube (mesurée de l'extrémité aux orifices)
F	Symmetrical to	Symmetrisch zu	Symétrique à

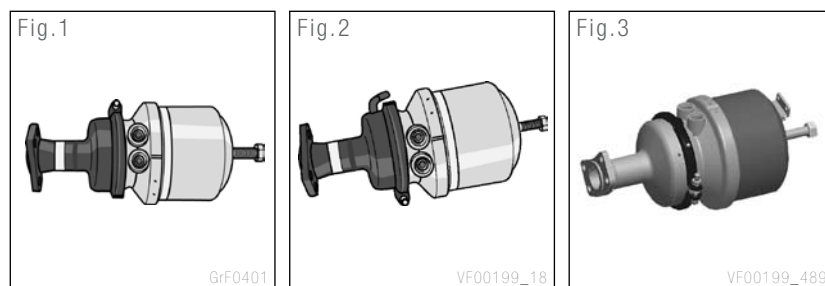

Part Number	Type Number	Fig.	A	B	C x100[N]	D [mm]	E [mm]	F
II18523000	BY9103	1	M22x1,5 Voss	9/16	96,6	53/53	172	BY9104
II18524000	BY9104	1	M22x1,5 Voss	9/16	96,6	53/53	172	BY9103
II18525000	BY9153	1	M22x1,5 Voss	10,5/16	85	53/53	175	BY9154
II18526000	BY9154	1	M22x1,5 Voss	10,5/16	85	53/53	175	BY9153
II16575000	BY9200	1	M22x1,5 Voss	12/16	85	53/53	175	BY9201
II16576000	BY9201	1	M22x1,5 Voss	12/16	85	53/53	175	BY9200
K004056	BY9223	2	M22x1,5 Voss	12/16	65	50/50	175	BY9224
K004057	BY9224	2	M22x1,5 Voss	12/16	65	50/50	175	BY9223
K004058	BY9227	2	M22x1,5 Voss	10,5/16	85	53/53	175	BY9228
K004059	BY9228	2	M22x1,5 Voss	10,5/16	85	53/53	175	BY9227
II30393000	BY9263	1	M16x1,5	14/24	102	53/53	200	
K019976N00	BY9282	3	M22x1,5 Voss	14/24	102	53/53	175	BY9283
K019977N00	BY9283	3	M22x1,5 Voss	14/24	102	53/53	175	BY9282
II35117000	BY9321	1	M16x1,5	16/24	102	53/53	200	
K003964N00	BY9322	2	M22x1,5 Voss	16/24	102	53/53	175	BY9323
K004064N00	BY9323	2	M22x1,5 Voss	16/24	102	53/53	175	BY9322
K019993N00	BY9334	1	M22x1,5 Voss	16/24	102	53/53	175	BY9335
K019994N00	BY9335	1	M22x1,5 Voss	16/24	102	53/53	175	BY9334
K020814N00	BY9338	1	M16x1,5	18/20	87	53/53	175	
K021178N00	BY9340	1	M16x1,5	16/20	87	53/53	170	BY9341
K021179N00	BY9341	1	M16x1,5	16/20	87	53/53	170	BY9340
K020004N00	BY9466	3	M22x1,5 Voss	22/24	112	53/53	181	BY9467
K020005N00	BY9467	3	M22x1,5 Voss	22/24	112	53/53	181	BY9466

Spring Brakes (Disc) – Diaphragm / Piston

Cylindres Double (Disque) – Membrane / Piston

Kombizylinder Membran / Kolben für Scheibenbremse

Cilindri Doppi a Molla (Disco) – Membrana / Stantuffo

Legend	Legende	Légende	Legenda
A Port size	Anschlussgewinde	Raccord	Raccordi
B Type	Art	Type	Tipo
C Spring portion rating	Federspeicherkraftabgabe	Effort frein de stationnement	Forza freno di stazionamento
D Stroke of service portion / stroke of spring portion	Hub Betriebsbremsteil / Federspeicherteil	Course (frein de service / service/frein de stationnement)	Corsa (corsa freno di servizio / corsa freno di stazionamento)
E Push rod protrusion	Vorstehmaß Kolbenstange	Dépassement du poussoir	Sporgenza asta di spinta
F Mounting nuts fitted	Mit Befestigungsmuttern	Equipée d'écrous de montage	Con dadi di fissaggio



Part Number	Type Number	Fig.	A	B	C x100[N]	D [mm]	E [mm]	F
K026887N00	BS6408	1	M16x1,5	20/24	73	64/64	15	–
K026888N00	BS6409	1	M16x1,5	20/24	73	64/64	15	–
K028699N00	BS6411	1	M22x1,5 Voss	20/24	73	64/64	15	–
K028700N00	BS6412	1	M22x1,5 Voss	20/24	73	64/64	15	–
K028809N00	BS6413	2	M16x1,5	20/130		64/64	15	–
K028810N00	BS6414	2	M16x1,5	20/130		64/64	15	–
K029229N00	BS6415	2	M16x1,5	20/130		64/64	15	–
K029230N00	BS6416	2	M16x1,5	20/130		64/64	15	–
K038828N00	BS6421	1	M22x1,5	20/24	73	64/64	15	–
K038829N00	BS6422	1	M22x1,5	20/24	73	64/64	15	–
K031451N00	BS8263	1	M16x1,5	14/16		57/57	15	–
K031469N00	BS8264	1	M16x1,5	14/16		57/57	15	–
II40309F	BS8312	1	M22x1,5 Voss	16/24HFL3	131	64/64	15	–
K000976	BS8316	3	M16x1,5	16/27	128	57/57	15	–
K000977	BS8317	3	M16x1,5	16/27	128	57/57	15	–
K001899	BS8323	3	M16x1,5	16/27	128	57/57	15	–
K007655	BS8328	3	M22x1,5 Voss	16/24HFL1	112	57/57	15	–
K007656	BS8329	3	M22x1,5 Voss	16/24HFL1	112	57/57	15	–
K004876N00	BS8330	1	M22x1,5 Voss	16/24HFL3	112	64/64	15	–
K004877N00	BS8331	1	M22x1,5 Voss	16/24HFL3	112	64/64	15	–
K007648	BS8332	3	M22x1,5	16/16	76	57/57	15	–
K007649	BS8333	3	M22x1,5	16/16	76	57/57	15	–
K007653	BS8334	3	M22x1,5 Voss	16/16	76	57/57	15	–
K007654	BS8335	3	M22x1,5 Voss	16/16	76	57/57	15	–

Part Number	Type Number	Fig.	A	B	C x100[N]	D [mm]	E [mm]	F
K007045000	BS8337	4	M16x1,5	16/16	95	57/57	15	–
K007049N00	BS8338	4	M16x1,5	16/16	95	57/57	15	–
K016484	BS8350	1	M16x1,5	18/16		57/57	15	–
K016485	BS8351	1	M16x1,5	18/16		57/57	15	–
K014919	BS8392	1	M16x1,5	18/24HFL3		64/64	15	–
K014920	BS8393	1	M16x1,5	18/24HFL3		64/64	15	–
K004044000	BS8402	1	M22x1,5 Voss	20/24HFL3	112	64/64	15	–
K004045000	BS8403	1	M22x1,5 Voss	20/24HFL3	112	64/64	15	–
K007668	BS8413	1	M22x1,5 Voss	20/24HFL1	112	64/64	15	–
K007669	BS8414	1	M22x1,5 Voss	20/24HFL1	112	64/64	15	–
K007670	BS8415	3	M22x1,5	20/24HFL1	95	75/75	20	–
K007657	BS8420	3	M22x1,5 Voss	20/24	102	64/64	15	–
K007658	BS8421	3	M22x1,5 Voss	20/24	102	64/64	15	–
K007677	BS8426	1	M22x1,5 Voss	20/24HFL3	112	64/64	15	–
K010024N00	BS8426	2	M22x1,5 Voss	20/24HFL3	112	64/64	15	–
K007678	BS8427	1	M22x1,5 Voss	20/24HF	112	64/64	15	–
K010025N00	BS8427	2	M22x1,5 Voss	20/24HF	112	64/64	15	–
K010026N00	BS8428	2	M22x1,5 Voss	20/24HFL3	131	64/64	15	–
K010027N00	BS8429	2	M22x1,5 Voss	20/24HFL3	131	64/64	15	–
K002200000	BS8430	1	M22x1,5 Voss	20/24HFL3	131	64/64	15	–
K002201000	BS8431	1	M22x1,5 Voss	20/24HFL3	131	64/64	15	–
K007675	BS8434	3	M22x1,5	20/24HFL1	111	64/64	15	–
K007676	BS8435	1	M22x1,5	20/24HFL1	111	64/64	15	–
K004682	BS8436	4	M16x1,5	20/27		57/57	15	–
K004683	BS8437	4	M16x1,5	20/27		57/57	15	–
II40500F	BS8450	4	M22x1,5 Voss	22/24	101	64/64	15	–
K000699	BS8452	3	M16x1,5	20/24	101	64/64	15	–
K000700	BS8453	3	M16x1,5	20/24	101	64/64	15	–
K007130000	BS8458	4	M16x1,5	20/24	101	57/57	15	–
K007131N00	BS8459	4	M16x1,5	20/24	101	57/57	15	–
K007138N00	BS8460	4	M16x1,5	22/24	101	64/64	15	–
K007139N00	BS8461	4	M16x1,5	22/24	101	64/64	15	–
K010964N00	BS8472	1	M16x1,5	22/24	101	64/64	15	–
K010965N00	BS8473	1	M16x1,5	22/24	101	64/64	15	–
K013837	BS8482	4	M16x1,5	22/27		64/64	15	–
K013838	BS8483	4	M16x1,5	22/27		64/64	15	–
K026632	BS8484	4	M16x1,5	22/24		64/64	15	–
K038830N00	BS8485	4	M16x1,5	22/24		57/57	15	–
K017119N00	BS8500	3	M16x1,5	24/30	130	57/57	15	–
K017120N00	BS8501	3	M16x1,5	24/30	130	57/57	15	–
II38547F	BS8506	1	M22x1,5 Voss	24/24HFL3	112	64/64	15	–
K007135000	BS8507	4	M16x1,5	24/24	101	57/57	15	–

Spring Brakes (Disc) – Diaphragm / Piston

Cylindres Double (Disque) – Membrane / Piston

Kombizylinder Membran / Kolben für Scheibenbremse

Cilindri Doppia a Molla (Disco) – Membrana / Stantuffo

Part Number	Type Number	Fig.	A	B	C x100[N]	D [mm]	E [mm]	F
K007136000	BS8508	4	M16x1,5	24/24	101	57/57	15	–
K011682	BS8510	4	M16x1,5	24/24	101	57/57	15	–
II38922F	BS8516	1	M22x1,5	24/24HFL1	112	64/64	15	–
II39219F	BS8517	3	M16x1,5	24/24	83	64/64	15	–
II39220F	BS8518	3	M16x1,5	24/24	83	64/64	15	–
II39614F	BS8519	3	M16x1,5	24/14	64	64/45	15	–
II39929FN00	BS8520	1	M22x1,5 Voss	24/24HFL3	130	64/64	15	–
II39930FN00	BS8521	1	M22x1,5 Voss	24/24HFL3	130	64/64	15	–
K017121N00	BS8525	3	M16x1,5	24/30	130	57/57	15	–
K017122N00	BS8526	3	M16x1,5	24/30	130	57/57	15	–
K007684	BS8544	3	M22x1,5	24/24HFL1	112	64/64	15	–
K007685	BS8545	3	M22x1,5	24/24HFL1	112	64/64	15	–
K005582N00	BS8548	1	M22x1,5 Voss	24/24HFL3	130	64/64	15	–
K005583N00	BS8549	1	M22x1,5 Voss	24/24HFL3	130	64/64	15	–
K014686	BS8550	4	M16x1,5	24/30		64/64	15	–
K014687	BS8551	4	M16x1,5	24/30		64/64	15	–
K014688	BS8552	4	M16x1,5	24/30		64/64	15	–
K029059N00	BS8559	4	M16x1,5	24/24		64/64	15	–
K029501N00	BS8560	2	M16x1,5	24/130		64/45	15	–
K029502N00	BS8561	2	M16x1,5	24/130		64/45	15	–
K039066N00	BS8562	2	M16x1,5	24/130		64/45	15	–
K039067N00	BS8563	2	M16x1,5	24/130		64/45	15	–
K007633	BS9082	3	M22x1,5	10/16	88	57/57	15	–
K007631	BS9083	3	M22x1,5 Voss	10/16	90	57/57	15	–
K007632	BS9084	3	M22x1,5 Voss	10/16	90	57/57	15	–
K007629	BS9086	3	M22x1,5 Voss	10/16	90	57/57	15	–
K007630	BS9087	3	M22x1,5 Voss	10/16	90	57/57	15	–
K007625	BS9092	3	M22x1,5 Voss	10/16	65	57/57	20	–
K007626	BS9093	3	M22x1,5 Voss	10/16	65	57/57	20	–
K007038N00	BS9177	3	M16x1,5	12/16	76	57/57	15	–
K007039000	BS9178	4	M16x1,5	12/16	76	57/57	15	–
K007640	BS9179	3	M22x1,5 Voss	12/16	95	57/57	15	–
K007641	BS9180	3	M22x1,5 Voss	12/16	95	57/57	15	–
II37520	BS9193	3	M22x1,5 Voss	12/16	65	57/57	15	–
K011359	BS9251	4	M16x1,5	14/16	76	57/57	15	–
K011360	BS9252	4	M16x1,5	14/16	76	57/57	15	–
K004017N00	BS9253	1	M22x1,5 Voss	16/24HFL3		64/64	15	–
K000978	BS9265	3	M16x1,5	14/27	128	57/57	15	–
K000979	BS9266	3	M16x1,5	14/27	128	57/57	15	–
K001902	BS9269	3	M16x1,5	14/27	128	57/57	15	–
K001903	BS9270	3	M16x1,5	14/27	128	57/57	15	–
K007644	BS9272	4	M22x1,5 Voss	14/16	76	57/57	15	–

Part Number	Type Number	Fig.	A	B	C x100[N]	D [mm]	E [mm]	F
K007645	BS9273	4	M22x1,5 Voss	14/16	76	57/57	15	–
K001976	BS9283	4	M16x1,5	14/16	76	57/57	15	–
II38428F	BS9287	3	M16x1,5	14/16	63	57/57	15	–
K007642	BS9296	3	M22x1,5 Voss	14/16	76	57/57	15	–
II31783	BS9297	3	M16x1,5	14/16	65	57/57	15	–
K002855N00	BS9305	3	M22x1,5 Voss	16/24	102	57/57	15	–
K002854N00	BS9306	3	M22x1,5 Voss	16/24	102	57/57	15	–
K002859N00	BS9308	1	M22x1,5 Voss	16/24HFL3	131	64/64	15	–
K002858N00	BS9311	3	M22x1,5 Voss	16/24HFL3	113	64/64	15	–
K002857N00	BS9320	1	M22x1,5 Voss	16/24HFL1	97	57/57	15	–
K002856N00	BS9321	1	M22x1,5 Voss	16/24HFL1	97	57/57	15	–
II38467F	BS9338	3	M16x1,5	16/24	85	57/57	15	–
K007055N00	BS9350	4	M16x1,5	18/24	101	57/57	15	–
K007054N00	BS9351	4	M16x1,5	18/24	101	57/57	15	–
II35736	BS9356	4	M22x1,5 Voss	18/24	101	64/64	15	–
K000909	BS9362	3	M16x1,5	18/27	105	57/57	15	–
K000910	BS9363	3	M16x1,5	18/27	105	57/57	15	–
K002002	BS9370	3	M16x1,5	18/27	128	57/57	15	–
K002003	BS9371	3	M16x1,5	18/27	128	57/57	15	–
II39213F	BS9373	3	M16x1,5	16/16	63	57/57	15	–
II39212FN00	BS9374	3	M16x1,5	16/16	63	57/57	15	–
II38496F	BS9377	3	M16x1,5	16/16	65	57/57	15	–
II38497F	BS9378	3	M16x1,5	16/16	65	57/57	15	–
II38465F	BS9379	3	M16x1,5	16/16	65	57/57	15	–
II37138000	BS9390	3	M16x1,5	16/16	65	57/57	15	–
II37139000	BS9391	3	M16x1,5	16/16	65	57/57	15	–
K007646	BS9395	3	M22x1,5 Voss	16/16	95	57/57	15	–
K007647	BS9396	3	M22x1,5 Voss	16/16	95	57/57	15	–
II31227	BS9397	3	M16x1,5	16/16	65	57/57	15	–
II18224	BS9398	3	M16x1,5	16/16	65	57/57	15	–
II31407000	BS9404	3	M16x1,5	20/24	83	57/57	15	–
K004033N00	BS9405	3	M22x1,5 Voss	20/24	102	64/64	15	–
K004034N00	BS9406	3	M22x1,5 Voss	20/24	102	64/64	15	–
K002861N00	BS9411	1	M22x1,5 Voss	20/24HFL3	112	64/64	15	–
K002860N00	BS9412	3	M22x1,5 Voss	20/24HFL3	112	64/64	15	–
K007086N00	BS9418	4	M16x1,5	20/24	102	57/57	15	–
K007087N00	BS9419	4	M16x1,5	20/24	102	57/57	15	–
II34000	BS9421	4	M16x1,5	20/27		64/64	15	–
II34185	BS9424	4	M16x1,5	20/27		64/64	15	–
K012376N00	BS9429	3	M22x1,5	20/24HFL1	95	64/64	15	–
K007661	BS9433	1	M22x1,5 Voss	20/24HFL1	95	75/75	20	–
K007662	BS9434	1	M22x1,5 Voss	20/24HFL1	95	75/75	20	–

Part Number	Type Number	Fig.	A	B	C x100[N]	D [mm]	E [mm]	F
K004042N00	BS9437	1	M22x1,5 Voss	20/24HFL3	131	64/64	15	–
K004043N00	BS9438	1	M22x1,5 Voss	20/24HFL3	112	64/64	15	–
II34389	BS9458	3	M22x1,5 Voss	20/24	83	64/64	15	–
II37906	BS9461	3	M22x1,5 Voss	22/24	83	64/64	15	–
K007659	BS9462	1	M22x1,5 Voss	20/24	83	64/64	20	–
K014922	BS9466	1	M16x1,5	20/24HFL3		64/64	15	–
K014923	BS9467	1	M16x1,5	20/24HFL3		64/64	15	–
II39613F	BS9468	2	M16x1,5	22/14		64/45	15	–
II38124F	BS9471	3	M16x1,5	20/24	85	57/57	15	–
II38408F	BS9476	3	M22x1,5 Voss	20/24	101	64/64	15	–
K004074	BS9476	3	M22x1,5 Voss	20/24	83	64/64	15	–
K004075	BS9478	3	M22x1,5 Voss	20/27	105	64/64	15	–
II38533F	BS9479	3	M16x1,5	20/24	83	57/57	15	–
K004040N00	BS9480	1	M22x1,5 Voss	20/24HFL1	112	57/57	15	–
K004041N00	BS9481	1	M22x1,5 Voss	20/24HFL1	112	57/57	15	–
K007665	BS9482	3	M22x1,5	20/24HFL1	95	75/75	20	–
K007666	BS9483	1	M22x1,5	20/24HFL1	95	75/75	20	–
II38599F	BS9486	3	M16x1,5	20/24	85	57/57	15	–
K004031000	BS9491	3	M22x1,5 Voss	20/24	101	57/57	15	–
K004032000	BS9492	3	M22x1,5 Voss	20/24	101	57/57	15	–
II40310F	BS9497	1	M22x1,5 Voss	20/24HFL3	131	64/64	15	–
II40311F	BS9498	1	M22x1,5 Voss	20/24HFL3	131	64/64	15	–
K004050000	BS9500	4	M22x1,5 Voss	24/24	101	57/57	15	–
K004052N00	BS9502	1	M22x1,5 Voss	24/24HFL3	112	64/64	15	–
II32609000	BS9504	3	M22x1,5 Voss	24/24	83	64/64	15	–
II32697000	BS9505	4	M22x1,5 Voss	24/24	102	64/64	15	–
K004046N00	BS9507	3	M22x1,5 Voss	24/130	68	64/45	15	–
K004051000	BS9508	4	M22x1,5 Voss	24/24	102	57/57	15	–
K004053000	BS9509	3	M22x1,5 Voss	24/24HFL3	112	64/64	15	–
K018094N00	BS9510	3	M16x1,5	24/14	52	64/45	15	–
K004047N00	BS9514	3	M22x1,5 Voss	24/130	68	64/45	15	–
II34388	BS9520	3	M22x1,5 Voss	24/24	83	57/57	15	–
K017123N00	BS9527	3	M16x1,5	24/30	130	57/57	15	–
II37282	BS9534	3	M22x1,5 Voss	24/24	102	64/64	15	–
II37468	BS9535	3	M22x1,5 Voss	24/24HFL1	98	64/64	15	–
K007683	BS9535	3	M22x1,5 Voss	24/24HFL1	98	64/64	15	–
II37747000	BS9536	3	M16x1,5	24/30	131	57/57	15	–
II38085	BS9541	4	M22x1,5	20/24HF		64/64	20	–
K011452000	BS9543	1	M22x1,5 Voss	24/24HFL3	131	64/64	15	–
K011453	BS9544	1	M22x1,5 Voss	24/24HFL3	131	64/64	15	–
K010566	BS9563	3	M22x1,5 Voss	27/24		64/64	15	–
K013772	BS9573	4	M16x1,5	24/24		64/57	15	–

32 (32.6)

Spring Brakes (Disc) – Diaphragm / Piston

Cylindres Double (Disque) – Membrane / Piston

Kombizylinder Membran / Kolben für Scheibenbremse

Cilindri Doppia a Molla (Disco) – Membrana / Stantuffo

Part Number	Type Number	Fig.	A	B	C x100[N]	D [mm]	E [mm]	F
K013773	BS9574	4	M16x1,5	24/24		64/57	15	–
K015762	BS9580	1	M16x1,5	24/24HFL1	98	64/64	15	–
K010006	BT4700	2	M16x1,5	18/24HFL3	100	64/64	15	–
K010007	BT4701	2	M16x1,5	18/24HFL3	100	64/64	15	–
K009968	BT4800	2	M16x1,5	18/27	100	64/64	15	–
K009969	BT4801	2	M16x1,5	18/27	100	64/64	15	–
K010002	BT4802	2	M16x1,5	18/27		57/57	15	–
K010003	BT4803	2	M16x1,5	18/27		57/57	15	–
K010004	BT4804	2	M16x1,5	18/27		57/57	15	–
K010005	BT4805	2	M16x1,5	18/27		57/57	15	–
K018155	BT5708	2	M16x1,5	24/24HFL3		64/64	15	–
K018158	BT5709	2	M16x1,5	24/24HFL3		64/64	15	–
K009970	BT5800	2	M16x1,5	20/27	100	64/64	15	–
K009971	BT5801	2	M16x1,5	20/27	100	64/64	15	–
K010119	BT5802	2	M16x1,5	20/27		57/57	15	–
K010121	BT5803	2	M16x1,5	20/27		57/57	15	–

Spring Brakes (Disc) – Diaphragm / Diaphragm

Cylindres Double (Disque) – Membrane / Membrane

Kombizylinder Membran / Membran für Scheibenbremse

Cilindri Doppi a Molla (Disco) – Membrana / Membrana

	Legend	Legende	Légende	Legenda
A	Port size	Anschlussgewinde	Raccord	Raccordi
B	Type	Art	Type	Tipo
C	Spring portion rating	Federspeicherkraftabgabe	Effort frein de stationnement	Forza freno di stazionamento
D	Stroke of service portion / stroke of spring portion	Hub Betriebsbremsteil / Federspeicherteil	Course (frein de service / service/frein de stationnement)	Corsa (corsa freno di servizio / corsa freno di stazionamento)
E	Push rod protrusion	Vorstehmaß Kolbenstange	Dépassement du poussoir	Sporgenza asta di spinta
F	Mounting nuts fitted	Mit Befestigungsmuttern	Equipée d'écrous de montage	Con dadi di fissaggio

Fig.1

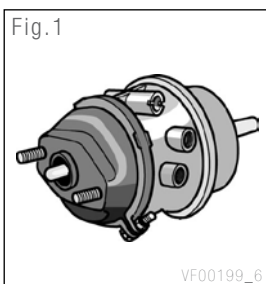

Part Number	Type Number	Fig.	A	B	C x100[N]	D [mm]	E [mm]	F
K026894N00	BS7304	1	M16x1,5	16/24	73	57/57	15	–
K026896N00	BS7309	1	M16x1,5	16/24	73	57/57	15	–
K026898N00	BS7312	1	M16x1,5	16/24	73	57/57	15	–
K026899N00	BS7313	1	M16x1,5	16/24	73	57/57	15	–
K026900N00	BS7318	1	M16x1,5	16/24	73	57/57	15	–
K026901N00	BS7319	1	M16x1,5	16/24	73	57/57	15	–
K026903N00	BS7351	1	M16x1,5	18/24	73	57/57	15	–
K026904N00	BS7355	1	M16x1,5	18/24	73	57/57	15	–
K026905N00	BS7356	1	M16x1,5	18/24	73	57/57	15	–

	Legend	Legende	Légende	Legenda
A	Port size	Anschlussgewinde	Raccord	Raccordi
B	Spring portion rating	Federspeicherkraftabgabe	Effort frein de stationnement	Forza freno di stazionamento
C	Stroke	Hub	Course	Corsa
D	Push rod thread or yoke (Y)	Kolbenstangengewinde, Gabelkopf (Y)	Tige filetée ou chape (Y)	Asta di spinta filettata, forcella (Y)

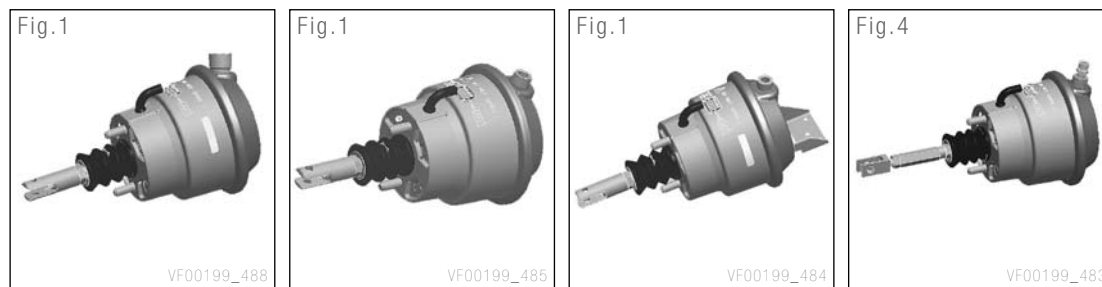

Part Number	Type Number	Fig.	A	B x100[N]	C [mm]	D
K026832N00	DPA5000	1	M22x1,5 Voss	50	40	Y
K028253N00	DPA5001	2	M16x1,5	50	40	Y
K026831N00	DPA6100	1	M22x1,5 Voss	61	40	Y
K028254N00	DPA6101	2	M16x1,5	61	40	Y
K028266N00	DPA6102	3	M16x1,5	61	40	Y
K028300N00	DPA6103	2	M16x1,5	61	40	Y
K028388N00	DPA6104	4	M16x1,5	61	40	Y

	Legend	Legende	Légende	Legenda
A	Jaw width	Gabelweite	Largeur Mâchoire	Larghezza apertura
B	Pin Ø	Bolzen-Ø	Ø Pin	Ø del Perno
C	Thread	Gewinde	Filetage	Filettatura



Part Number	Type Number	Fig.	A [mm]	B [mm]	C
1188851	–	1	14,7	13,85	5/8" UNF
205948DK	–	1	14,3	12,5	1/2" UNF
267086	–	1	15,2	16,0	M16x1,5
269700	–	1	14,7	16,0	M14x1,5
272917	–	1	14,7	12,5	M16x1,5
274520	–	1	14,7	13,85	5/8" UNF
295517	–	1	14,7	13,85	M16x1,5
295518	–	1	14,7	13,85	M14x1,5
EF1AK	–	2	14,5	14,0	M16x1,5
II37099	–	1	14,5	14,0	M16x1,5
SEB01315	–	2	14,5	14,0	M16x1,5
SEB01316	–	3	14,5	14,0	M16x1,5

	Page
35.1 Slack Adjusters (Automatic)	155
35.2 Slack Adjusters (Manual)	158
	Seite
35.1 Gestängesteller, automatisch	155
35.2 Gestängesteller, manuell	158
	Page
35.1 Leviers Régleurs (Automatique)	155
35.2 Leviers Régleurs (Manuel)	158
	Pagina
35.1 Leve di Registro (Automatiche)	155
35.2 Leve di Registro (Manuali)	158

Slack Adjusters (Automatic)
Gestängesteller, automatisch

Leviers Régleurs (Automatique)
Leve di Registro (Automatiche)

Legend	Legende	Légende	Legenda
A	Spline type	Zahnnaben-Type	Cannelure type
A ₁	1,5" SAE 10C	1,5" SAE 10C	1,5" SAE 10C
A ₂	19 Spline DIN 5482	19 Zahnnabe DIN 5482	19 Cannelure DIN 5482
A ₃	26 Spline DIN 5480 N42 x 1,5	26 Zahnnabe DIN 5480 N42 x 1,5	26 Cannelure DIN 5480 N42 x 1,5
A ₄	27 Spline E22-151 BNA-42 x 1,5	27 Zahnnabe E22-151 BNA-42 x 1,5	27 Cannelure E22-151 BNA-42 x 1,5
A ₅	28 Spline ANSI B92-1	28 Zahnnabe ANSI B92-1	28 Cannelure ANSI B92-1
A ₆	37 Spline ANSI B92-1	37 Zahnnabe ANSI B92-1	37 Cannelure ANSI B92-1
B	Effective length	Wirksame Länge	Longueur effective
C	Left offset (L mm) or Right offset (R mm) Straight (-)	Absatzmass links (L mm) oder rechts (R mm) Gerade (-)	Montage à gauche (L mm) ou montage à droite (R mm) directement (-)
D	Maximum torque	Maximales Drehmoment	Couple maximum
E	Hole sizes	Bohrungsdurchmesser	Dimension des trous

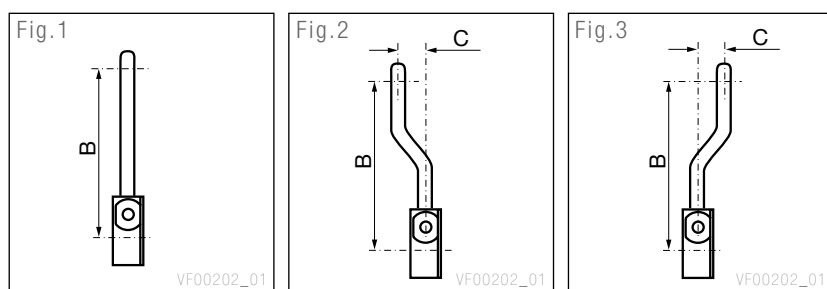

Part Number	Type Number	Fig.	A	B	C	D [Nm]	E
KB1000	-	1	A ₁	115/127/140/153/205	-	3390	14,0
KB1010	-	1	A ₁	120/135/150/165/180/250	-	3389	14,0
KB1030	-	1	A ₁	105/125/140/155/180/250	-	3390	14,0
KB1500	-	1	A ₁	120/135/150/165/180/250	-	2950	14,0
KB1505	-	1	A ₁	115/127/140/153/205	-	2950	14,0
KB1510	-	1	A ₆	105/129/153/215	-	2950	14,0 & 16,0
KB1515	-	1	A ₁	105/125/140/155/180/250	-	2950	14,0
KB1520	-	1	A ₁	105/129/153/215	-	2950	14,0 & 16,0
KB1525	-	1	A ₁	125/150/180/210	-	2950	14,0
KB1530	-	1	A ₆	125/150	-	2950	12,7
KB1535	-	1	A ₁	125/140/155/180	-	2950	14,0
KB2010	-	3	A ₁	140	R 38	2485	14,0
KB2015	-	2	A ₁	140	L 38	2485	14,0
KB2020	-	3	A ₁	165	R 45	2260	14,0
KB2025	-	2	A ₁	165	L 45	2260	14,0
KB2040	-	1	A ₃	145	-	3389	14,0
KB2070	-	3	A ₃	145	R 56	2260	14,0
KB2075	-	2	A ₃	145	L 56	2260	14,0

35 (35.1)

Slack Adjusters (Automatic)
Gestängesteller, automatisch

Leviers Régleurs (Automatique)
Leve di Registro (Automatiche)

Part Number	Type Number	Fig.	A	B	C	D [Nm]	E
KB2080	–	1	A ₃	145	–	3390	14,0
KB2115	–	3	A ₁	140	R 38	2485	14,0
KB2125	–	2	A ₁	140	L 38	2485	14,0
KB2170	–	1	A ₅	140	–	3390	12,8
KB2220	–	2	A ₁	165	L 25	2710	16,0
KB2230	–	3	A ₄	175	R 38	2485	14,0
KB2235	–	1	A ₅	127	–	3390	12,8
KB2240	–	2	A ₄	175	L 38	2485	14,0
KB2245	–	3	A ₄	175	R 38	2485	14,0
KB2250	–	1	A ₁	165	–	3390	16,0
KB2260	–	3	A ₁	165	R 25	2710	16,0
KB2275	–	1	A ₁	140	–	3390	12,8
KB2610	–	2	A ₃	145	L 56	2260	14,0
KB2615	–	3	A ₃	145	R 56	2260	14,0
KB2630	–	3	A ₄	160	R 56	2260	14,0
KB2635	–	2	A ₄	160	L 56	2260	14,0
KB2735	–	3	A ₁	165	R 65	2260	16,0
KB2740	–	2	A ₁	165	L 65	2260	16,0
KB2775	–	3	A ₂	160	R 22	2710	14,0
KB2780	–	2	A ₂	160	L 22	2710	14,0
KB2920	–	3	A ₄	160	R 56	2260	14,0
KB3030	–	2	A ₂	149	L 22	2711	14,0
KB3035	–	3	A ₂	150	R 22	2710	14,0
KB3040	–	3	A ₄	160	R 56	2260	14,0
KB3045	–	2	A ₄	160	L 56	2260	14,0
KB3485	–	3	A ₅	160	R 38	2485	14,0
KB3490	–	2	A ₅	160	L 38	2485	14,0
KB6500	–	3	A ₃	145	R 56	2350	14,0
KB6505	–	2	A ₃	145	L 56	2350	14,0
KB6510	–	2	A ₃	145	L 37	2350	14,0
KB6515	–	3	A ₃	145	R 37	2350	14,0
KB6520	–	3	A ₃	145	R 56	2350	14,0
KB6525	–	2	A ₃	145	L 56	2350	14,0
KB6530	–	3	A ₃	145	R 42	2470	14,0
KB6535	–	2	A ₃	145	L 42	2470	14,0
KB6540	–	2	A ₃	145	L 56	2350	14,0
KB6545	–	3	A ₃	145	R 56	2350	14,0
KB6620	–	3	A ₃	145	R 56	2330	14,0
KB6625	–	2	A ₃	145	L 56	2330	14,0
KB6630	–	3	A ₃	145	R 56	2330	14,0
KB6660	–	2	A ₃	145	L 56	2330	14,0
KB6665	–	1	A ₆	155	–	2950	14,0

Slack Adjusters (Automatic)
Gestängesteller, automatisch

Leviers Régleurs (Automatique)
Leve di Registro (Automatiche)

Part Number	Type Number	Fig.	A	B	C	D [Nm]	E
KB6670	–	3	A ₃	130	R 124	1355	14,0
KB6675	–	2	A ₃	130	L 124	1355	14,0

Legend	Legende	Légende	Legenda
A	Spline type	Zahnnaben-Type	Cannelure type
A ₁	1,5" SAE 10C	10 Zahnnabe: 1,5" SAE 10C	1,5" SAE 10C
A ₂	37 Spline ANSI B92-1	37 Zahnnabe ANSI B92-1	37 Scanalature ANSI B92-1
B	Effective length	Wirksame Länge	Longueur effective
C	Left offset (L mm) or Right offset (R mm) Straight (-)	Absatzmass links (L mm) oder rechts (R mm) gerade (-)	Montage à gauche (L mm) ou montage à droite (R mm) directement (-)
D	Maximum torque	Drehmomentklasse	Couple
E	Hole sizes	Bohrungsdurchmesser	Ø Dimensione del foro

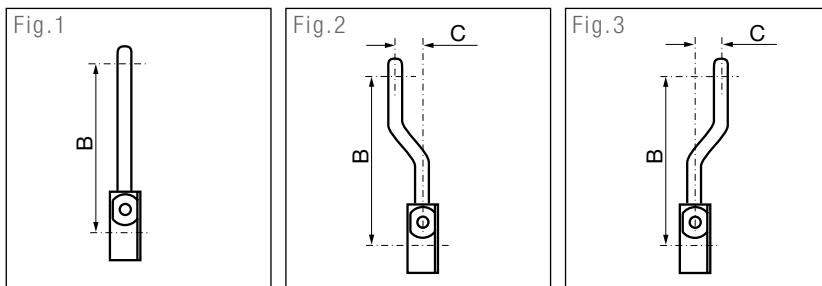

Part Number	Type Number	Fig.	A	B [mm]	C	D [Nm]	E [mm]
1186872	-	1	A ₁	178	-	PL30	14,0
1189483	-	2	A ₁	165	L 65	PL18	16,0
1189484	-	3	A ₁	165	R 65	PL18	16,0
1194360	-	1	A ₁	127/152/178/203	-	PL20	14,0
1194361	-	1	A ₁	127/152/178/203	-	PL20	12,7
1194362	-	1	A ₁	127/152/178/203	-	PL20	12,7
1194363	-	1	A ₁	127/152/178/203	-	PL20	14,0
1194379	-	1	A ₂	105/130/150/180/215	-		14,0/18,0
1194390	-	1	A ₂	105/130/150/180/215	-		14,0/16,0
267026	-	3	A ₁	165	R 25	PL24	16,0
267027	-	2	A ₁	165	L 25	PL24	16,0
267083	-	2	A ₁	165	L 50	PL18	16,0
267084	-	3	A ₁	165	R 50	PL18	16,0
272862	-	3	A ₁	130	R 16	PL18	16,0
272863	-	2	A ₁	130	L 16	PL18	16,0
274657	-	1	A ₁	140	-	PL20	12,8
295334	-	1	A ₁	152/178	-	PL30	16,0
295567	-	1	A ₁	165	-	PL30	16,0

	Page
36.1 Air Disc Brakes	160
36.2 Rationalised Calipers	161
36.3 Brake Discs	183
	Seite
36.1 Pneumatische Scheibenbremsen	160
36.2 Vereinheitlichte Zuspänneinheiten	161
36.3 Bremsscheiben	183
	Page
36.1 Freins à Disque Pneumatique	160
36.2 Etriers Rationalisés	161
36.3 Disques de Frein	183
	Pagina
36.1 Freni a Disco Pneumatici	160
36.2 Pinze Razionalizzate	161
36.3 Dischi Freno	183

Legend	Legende	Légende	Legenda
A	Angle of brake actuator centre line to axis of axle	Winkel der Bremszylinderachse zu Fahrzeugachse	Angle d'inclinaison du cylindre par rapport à l'axe de l'essieu
B	To suit wheel size	Für Radgröße	Per dimensione ruota
C	Wear sensor: In-pad, normally closed	Verschleissensor: Kontakt geschlossen	Indicateur d'usure: Sur les plaquettes, Normalement fermé

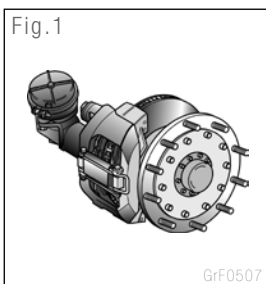

Part Number	Type Number	Fig.	A [°]	B [°]	Legend
K016153	T3700-D	1	10	19,5	C
K016152	T3700-I	1	10	19,5	C
131.777	T4300-D	1	10	22,5	C
131.776	T4300-I	1	10	22,5	C

NOTE: For all other Air Disc Brakes in the Knorr-Bremse product range a Rationalised Caliper is available. To find the appropriate Rationalised Caliper look up the Air Disc Brake part number in the following pages.

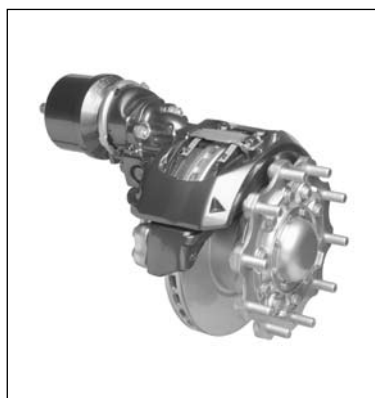

HINWEIS: Für alle anderen pneumatischen Scheibenbremsen von Knorr-Bremse sind vereinheitlichte Zuspanneinheiten verfügbar. Diese finden sie anhand der entsprechenden Nummer der pneumatischen Scheibenbremse auf den folgenden Seiten.

NOTE: Pour tous les autres produits de la gamme de frein à disque Knorr-Bremse, des étriers rationalisés sont disponibles. Pour trouver l'étrier rationalisé approprié, cherchez la référence du frein à disque dans les pages suivantes.

NOTA: Per tutti gli altri Freni a Disco Pneumatici Knorr-Bremse in catalogo, sono disponibili le pinze razionalizzate. Per trovare la giusta sostituzione, verificare il codice della pinza freno da sostituire nelle pagine seguenti.

Rationalised Calipers

- Replacement of the caliper means the existing brake actuator, brake carrier and brake pads can continue to be used if they are not damaged or worn.
- Replacement of the caliper provides a quick and cost effective option to major caliper servicing.
- Replacement of the caliper can, in most cases, be carried out on the vehicle.
- Calipers from the SB generation can, in most cases, be replaced by the higher specification SN generation.
- All rationalised calipers are TÜV approved.
- All rationalised calipers are supplied with the necessary installation fixings.

Vereinheitlichte Zuspanneinheiten

- Der Ersatz der Zuspanneinheit bedeutet, dass die vorhandenen Komponenten Bremszylinder, Bremsträger und Bremsbeläge weiterverwendet werden können, sofern sie nicht beschädigt oder verschlissen sind.
- Der Ersatz der Zuspanneinheit bietet die schnelle und kosten-günstige Lösung einer umfangreichen Wartung des Bremssattels.
- Der Austausch der Zuspanneinheit kann in den meisten Fällen direkt am Fahrzeug vorgenommen werden.
- Zuspanneinheiten der SB-Baureihe können in den meisten Fällen von der Nachfolgeneration der SN-Baureihe ersetzt werden.
- Alle vereinheitlichten Zuspanneinheiten sind vom TÜV genehmigt.
- Alle vereinheitlichten Zuspanneinheiten werden mit den notwendigen Einbaumaterialien geliefert.

Etriers Rationalisés

- Le remplacement d'un étrier permet aux cylindres de frein, support et plaquettes de frein existants de continuer à être utilisées que s'ils ne sont pas endommagés ou usés.
- Le remplacement de l'étrier fournit une option rapide et rentable pour un meilleur entretien de l'étrier.
- Le remplacement de l'étrier peut, dans la plupart des cas, être effectué sur le véhicule.
- Les étriers de la génération SB peuvent, dans la plupart des cas, être remplacés par la génération supérieure SN.
- Tous les étriers rationalisés sont homologués TÜV.
- Tous les étriers rationalisés sont fournis avec le nécessaire de fixation de montage.

Pinze Razionalizzate

- Con la pinza razionalizzata puoi riutilizzare i cilindri freno, la slitta e le pastiglie se non sono danneggiati o usurati.
- Con la pinza razionalizzata, la sostituzione è più veloce ed economica.
- La sostituzione della pinza razionalizzata può in molti casi essere effettuata senza rimuovere la slitta dal veicolo.
- Le pinze SB possono essere sostituite in molti casi con le razionalizzate della generazione SN.
- Tutte le pinze razionalizzate sono certificate TÜV.
- Tutte le pinze razionalizzate sono fornite con il kit necessario per il montaggio.



Legend		Legende		Légende		Legenda	
1) For SB5 Air Disc Brakes, when fitting a replacement Rationalised Caliper for the first time, it is necessary to also change the brake carrier.		Für Scheibenbremsen des Typs SB5 ist beim erstmaligen Austausch mit einer vereinheitlichten Zuspansseinheit ein Austausch des Bremsträgers erforderlich.		Pour les freins à disque pneumatiques SB5 lors du montage d'un étrier rationalisé pour la première fois, le support doit être aussi changé.		Per i Freni a Disco della serie SB5, quando si monta una Pinza Razionalizzata per la prima volta, é necessario sostituire anche la slitta.	
Dis Brake / Caliper Part No.	Dis Brake / Caliper Type No.	Rationalised Caliper Part No.	Rationalised Caliper Type No.	Dis Brake / Caliper Part No.	Dis Brake / Caliper Type No.	Rationalised Caliper Part No.	Rationalised Caliper Type No.
II19451	SB7564	K002786	SB7419RC	II32802	SB7660	K003800	SN7211RC
II19453	SB6500	K003826	SN6565RC	II32802AT		K003800	SN7211RC
II30692	SB6502	K003826	SN6565RC	II32803	SB7670	K003799	SN7201RC
II30693	SB6512	K003825	SN6555RC	II32803AT		K003799	SN7201RC
II31017	SB6503	K003826	SN6565RC	II32806	SB6507	K013176	SN6567RC
II31017AT		K003826	SN6565RC	II32806AT		K013176	SN6567RC
II31017M1	SB6503	K003826	SN6565RC	II32807	SB6517	K013175	SN6557RC
II31018	SB6513	K003825	SN6555RC	II32807AT		K013175	SN6557RC
II31018AT		K003825	SN6555RC	II32812	SB7103	K002967	SB7462RC
II31018M1	SB6513	K003825	SN6555RC	II32812AT		K002967	SB7462RC
II31022	SB7041	K002786	SB7419RC	II32813	SB7113	K002966	SB7452RC
II31023	SB7051	K002785	SB7409RC	II32813AT		K002966	SB7452RC
II31984	SB7102	K003193	SB7465RC	II33420	SB7665	K002708	SB7401RC
II31984AT		K003193	SB7465RC	II33421	SB7675	K002709	SB7411RC
II31985	SB7112	K003192	SB7455RC	II33428	SB6508	K003826	SN6565RC
II31985AT		K003192	SB7455RC	II33429	SB6518	K003825	SN6555RC
II32203	SB7681	K002709	SB7411RC	II33430	SB7666	K003804	SN7332RC
II32203AT		K002709	SB7411RC	II33430AT		K003804	SN7332RC
II32204	SB7691	K002708	SB7401RC	II33431	SB7676	K003803	SN7322RC
II32204AT		K002708	SB7401RC	II33431AT		K003803	SN7322RC
II32798	SB7648	K003800	SN7211RC	II33432	SB7586	K003810	SN7216RC
II32798AT		K003800	SN7211RC	II33432AT		K003810	SN7216RC
II32799	SB7658	K003799	SN7201RC	II33433	SB7596	K003809	SN7206RC
II32799AT		K003799	SN7201RC	II33433AT		K003809	SN7206RC
II32800	SB7649	K003800	SN7211RC	II33981	SB7682	K002709	SB7411RC
II32800AT		K003800	SN7211RC	II33981AT		K002709	SB7411RC
II32801	SB7659	K003799	SN7201RC	II33981V1	SB7682	K002709	SB7411RC
II32801AT		K003799	SN7201RC	II33981V2	SB7682	K002709	SB7411RC

Rationalised Calipers
Vereinheitlichte Zuspansseinheiten

Etriers Rationalisés
Pinze Razionalizzate

Dis Brake / Caliper Part No.	Dis Brake / Caliper Type No.	Rationalised Caliper Part No.	Rationalised Caliper Type No.
II33982	SB7692	K002708	SB7401RC
II33982AT		K002708	SB7401RC
II33982V1	SB7692	K002708	SB7401RC
II33982V2	SB7692	K002708	SB7401RC
II34161	SB6520	K003780	SN6563RC
II34161AT		K003780	SN6563RC
II34162	SB6530	K003779	SN6573RC
II34162AT		K003779	SN6573RC
II34323	SB7701	K003795	SN7189RC
II34323AT		K003795	SN7189RC
II34324	SB7711	K003796	SN7199RC
II34324AT		K003796	SN7199RC
II34325	SB7702	K003795	SN7189RC
II34325AT		K003795	SN7189RC
II34326	SB7712	K003796	SN7199RC
II34326AT		K003796	SN7199RC
II34452	SB7703	K003784	SN7196RC
II34452AT		K003784	SN7196RC
II34453	SB7713	K003783	SN7186RC
II34453AT		K003783	SN7186RC
II34454	SB7704	K003784	SN7196RC
II34454AT		K003784	SN7196RC
II34455	SB7714	K003783	SN7186RC
II34455AT		K003783	SN7186RC
II34456	SB7705	K003804	SN7332RC
II34456AT		K003804	SN7332RC
II34457	SB7715	K003803	SN7322RC
II34457AT		K003803	SN7322RC
II34458AT		K003804	SN7332RC
II34459AT		K003803	SN7322RC
II34464	SB7709	K003795	SN7189RC
II34465	SB7719	K003796	SN7199RC
II34465AT		K003796	SN7199RC
II34487	SB7721	K003784	SN7196RC
II34487AT		K003784	SN7196RC
II34488	SB7731	K003783	SN7186RC
II34488AT		K003783	SN7186RC
II34498	SB7105	K002963	SB7460RC
II34594	SB7707	K003784	SN7196RC
II34594AT		K003784	SN7196RC
II34595	SB7717	K003783	SN7186RC
II34595AT		K003783	SN7186RC

Dis Brake / Caliper Part No.	Dis Brake / Caliper Type No.	Rationalised Caliper Part No.	Rationalised Caliper Type No.
II34598	SB7708	K003784	SN7196RC
II34598AT		K003784	SN7196RC
II34599	SB7718	K003783	SN7186RC
II34599AT		K003783	SN7186RC
II34603	SB7688	K002786	SB7419RC
II34603AT		K002786	SB7419RC
II34604	SB7698	K002785	SB7409RC
II34604AT		K002785	SB7409RC
II34820	SB7723	K003782	SN7195RC
II34821	SB7733	K003781	SN7185RC
II34898	SB7105	K002963	SB7460RC
II34898AT		K002963	SB7460RC
II34899	SB7115	K002962	SB7450RC
II34899AT		K002962	SB7450RC
II35396	SB7108	K002965	SB7461RC
II35396AT		K002965	SB7461RC
II35397	SB7118	K002964	SB7451RC
II35397AT		K002964	SB7451RC
II35401	SB7724	K003782	SN7195RC
II35401AT		K003782	SN7195RC
II35402	SB7734	K003781	SN7185RC
II35402AT		K003781	SN7185RC
II35540	SB7726	K003804	SN7332RC
II35540AT		K003804	SN7332RC
II35541	SB7736	K003803	SN7322RC
II35541AT		K003803	SN7322RC
II35957	SB7729	K003804	SN7332RC
II35957AT		K003804	SN7332RC
II35958	SB7739	K003803	SN7322RC
II35958AT		K003803	SN7322RC
II35964	SB7742	K003804	SN7332RC
II35965	SB7752	K003803	SN7322RC
II36430	SB7109	K002963	SB7460RC
II36430AT		K002963	SB7460RC
II36431	SB7119	K002962	SB7450RC
II36431AT		K002962	SB7450RC
II36490	SB7989	K002786	SB7419RC
II36490AT		K002786	SB7419RC
II36491	SB7999	K002785	SB7409RC
II36491AT		K002785	SB7409RC
II36503	SB7120	K003913	SB7463RC
II36504	SB7130	K003912	SB7453RC

Dis Brake / Caliper Part No.	Dis Brake / Caliper Type No.	Rationalised Caliper Part No.	Rationalised Caliper Type No.
II36681 ¹⁾	SB5003	K004572	SN5006RC
II36681AT ¹⁾		K004572	SN5006RC
II36682 ¹⁾	SB5013	K004573	SN5016RC
II36682AT ¹⁾		K004573	SN5016RC
II36683 ¹⁾	SB5002	K004570	SN5005RC
II36683AT ¹⁾	SB5002	K004570	SN5005RC
II36684 ¹⁾	SB5012	K004571	SN5015RC
II36684AT ¹⁾	SB5012	K004571	SN5015RC
II36685 ¹⁾	SB5003	K004572	SN5006RC
II36685AT ¹⁾		K004572	SN5006RC
II36686 ¹⁾	SB5013	K004573	SN5016RC
II36686AT ¹⁾		K004573	SN5016RC
II36687 ¹⁾	SB5002	K004570	SN5005RC
II36688 ¹⁾	SB5012	K004571	SN5015RC
II36689	SB7648	K003800	SN7211RC
II36689AT		K003800	SN7211RC
II36690	SB7658	K003799	SN7201RC
II36690AT		K003799	SN7201RC
II36691	SB7649	K003800	SN7211RC
II36691AT		K003800	SN7211RC
II36692	SB7659	K003799	SN7201RC
II36692AT		K003799	SN7201RC
II36693	SB7660	K003800	SN7211RC
II36694	SB7670	K003799	SN7201RC
II36694AT		K003799	SN7201RC
II36699	SB6506	K013178	SN6568RC
II36699AT		K013178	SN6568RC
II36700	SB6516	K013177	SN6558RC
II36700AT		K013177	SN6558RC
II36701	SB6507	K013176	SN6567RC
II36701AT		K013176	SN6567RC
II36702	SB6517	K013175	SN6557RC
II36702AT		K013175	SN6557RC
II36703	SB6506	K013178	SN6568RC
II36703AT		K013178	SN6568RC
II36704	SB6516	K013177	SN6558RC
II36704AT		K013177	SN6558RC
II36705	SB6507	K013176	SN6567RC
II36705AT		K013176	SN6567RC
II36706	SB6517	K013175	SN6557RC

Dis Brake / Caliper Part No.	Dis Brake / Caliper Type No.	Rationalised Caliper Part No.	Rationalised Caliper Type No.
II36706AT		K013175	SN6557RC
II36805	SB7757	K003805	SN7204RC
II36805AT		K003805	SN7204RC
II36999	SB7760	K003800	SN7211RC
II36999AT		K003800	SN7211RC
II37000	SB7770	K003799	SN7201RC
II37000AT		K003799	SN7201RC
II37001	SB7761	K003810	SN7216RC
II37001AT		K003810	SN7216RC
II37002	SB7771	K003809	SN7206RC
II37002AT		K003809	SN7206RC
II37006	SB7680	K002794	SB7430RC
II37006AT		K002794	SB7430RC
II37007	SB7690	K002793	SB7420RC
II37007AT		K002793	SB7420RC
II37015	SB7703	K003784	SN7196RC
II37015AT		K003784	SN7196RC
II37016	SB7713	K003783	SN7186RC
II37016AT		K003783	SN7186RC
II37017	SB7704	K003784	SN7196RC
II37017AT		K003784	SN7196RC
II37018	SB7714	K003783	SN7186RC
II37018AT		K003783	SN7186RC
II37019	SB7707	K003784	SN7196RC
II37019AT		K003784	SN7196RC
II37020	SB7717	K003783	SN7186RC
II37020AT		K003783	SN7186RC
II37021	SB7725	K003784	SN7196RC
II37022	SB7735	K003783	SN7186RC
II37025	SB6525	K013176	SN6567RC
II37025AT		K013176	SN6567RC
II37026	SB6535	K013175	SN6557RC
II37026AT		K013175	SN6557RC
II37029	SB7762	K003784	SN7196RC
II37029AT		K003784	SN7196RC
II37030	SB7772	K003783	SN7186RC
II37030AT		K003783	SN7186RC
II37061	SB7648	K003800	SN7211RC
II37061AT		K003800	SN7211RC
II37061DC		K003800	SN7211RC
II37062	SB7658	K003799	SN7201RC
II37062AT		K003799	SN7201RC

¹⁾ | See page 162 | Siehe Seite 162 | Voir page 162 | Vedere pagina 162

Rationalised Calipers
Vereinheitlichte Zuspansseinheiten

Etriers Rationalisés
Pinze Razionalizzate

Dis Brake / Caliper Part No.	Dis Brake / Caliper Type No.	Rationalised Caliper Part No.	Rationalised Caliper Type No.
II37062DC		K003799	SN7201RC
II37064	SB7659	K003799	SN7201RC
II37064AT		K003799	SN7201RC
II37077	SB7760	K003800	SN7211RC
II37077AT		K003800	SN7211RC
II37078	SB7770	K003799	SN7201RC
II37080	SB7767	K003784	SN7196RC
II37080AT		K003784	SN7196RC
II37081	SB7777	K003783	SN7186RC
II37081AT		K003783	SN7186RC
II37223	SB6503	K003826	SN6565RC
II37223AT		K003826	SN6565RC
II37224	SB6513	K003825	SN6555RC
II37224AT		K003825	SN6555RC
II37225	SB6508	K003826	SN6565RC
II37226	SB6518	K003825	SN6555RC
II37231	SB7780	K003810	SN7216RC
II37231AT		K003810	SN7216RC
II37232	SB7790	K003809	SN7206RC
II37246	SB7782	K003800	SN7211RC
II37246AT		K003800	SN7211RC
II37247	SB7792	K003799	SN7201RC
II37247AT		K003799	SN7201RC
II37380	SB7783	K003810	SN7216RC
II37381	SB7793	K003809	SN7206RC
II37390	SB7784	K003782	SN7195RC
II37390AT		K003782	SN7195RC
II37391	SB7794	K003781	SN7185RC
II37391AT		K003781	SN7185RC
II37392	SB7785	K003810	SN7216RC
II37392AT		K003810	SN7216RC
II37393	SB7795	K003809	SN7206RC
II37393AT		K003809	SN7206RC
II37398	SB7787	K002562	SB7403RC
II37398AT		K002562	SB7403RC
II37399	SB7797	K002561	SB7413RC
II37399AT		K002561	SB7413RC
II37419	SB7708	K003784	SN7196RC
II37420	SB7718	K003783	SN7186RC
II37423	SB7122	K003913	SB7463RC
II37423AT		K003913	SB7463RC
II37424	SB7132	K003912	SB7453RC

Dis Brake / Caliper Part No.	Dis Brake / Caliper Type No.	Rationalised Caliper Part No.	Rationalised Caliper Type No.
II37424AT		K003912	SB7453RC
II37686	SB6527	K003780	SN6563RC
II37686AT		K003780	SN6563RC
II37687	SB6537	K003779	SN6573RC
II37687AT		K003779	SN6573RC
II37690	SB6528	K002923	SB6401RC
II37690AT		K002923	SB6401RC
II37691	SB6538	K002924	SB6411RC
II37691AT		K002924	SB6411RC
II37699	SB7757	K003805	SN7204RC
II37791	SB7789	K002786	SB7419RC
II37791AT		K002786	SB7419RC
II37792	SB7799	K002785	SB7409RC
II37792AT		K002785	SB7409RC
II37793	SB7800	K003800	SN7211RC
II37793AT		K003800	SN7211RC
II37794	SB7810	K003799	SN7201RC
II37794AT		K003799	SN7201RC
II37797	SB6507	K013176	SN6567RC
II37797AT		K013176	SN6567RC
II37798	SB6517	K013175	SN6557RC
II37798AT		K013175	SN6557RC
II37799	SB6507	K013176	SN6567RC
II37799AT		K013176	SN6567RC
II37800	SB6517	K013175	SN6557RC
II37800AT		K013175	SN6557RC
II37801	SB6525	K013176	SN6567RC
II37801AT		K013176	SN6567RC
II37802	SB6535	K013175	SN6557RC
II37802AT		K013175	SN6557RC
II37803 ¹⁾	SB5003	K004572	SN5006RC
II37803AT ¹⁾		K004572	SN5006RC
II37804 ¹⁾	SB5013	K004573	SN5016RC
II37804AT ¹⁾		K004573	SN5016RC
II37805 ¹⁾	SB5003	K004572	SN5006RC
II37805AT ¹⁾		K004572	SN5006RC
II37806 ¹⁾	SB5013	K004573	SN5016RC
II37806AT ¹⁾		K004573	SN5016RC
II37808	SB7801	K003782	SN7195RC
II37808AT		K003782	SN7195RC

¹⁾ | See page 162 | Siehe Seite 162 | Voir page 162 | Vedere pagina 162

Dis Brake / Caliper Part No.	Dis Brake / Caliper Type No.	Rationalised Caliper Part No.	Rationalised Caliper Type No.
II37809	SB7811	K003781	SN7185RC
II37809AT		K003781	SN7185RC
II37810	SB6529	K003826	SN6565RC
II37810AT		K003826	SN6565RC
II37811	SB6539	K003825	SN6555RC
II37811AT		K003825	SN6555RC
II37812	SB7123	K002963	SB7460RC
II37812AT		K002963	SB7460RC
II37813	SB7133	K002962	SB7450RC
II37813AT		K002962	SB7450RC
II37814	SB7124	K002965	SB7461RC
II37814AT		K002965	SB7461RC
II37815	SB7134	K002964	SB7451RC
II37815AT		K002964	SB7451RC
II37816	SB7125	K002963	SB7460RC
II37816AT		K002963	SB7460RC
II37817	SB7135	K002962	SB7450RC
II37817AT		K002962	SB7450RC
II38038F	SB7803	K003796	SN7199RC
II38039F	SB7813	K003795	SN7189RC
II38039FAT		K003795	SN7189RC
II38340F	SB7127	K002967	SB7462RC
II38340FAT		K002967	SB7462RC
II38341F	SB7137	K002966	SB7452RC
II38341FAT		K002966	SB7452RC
II38342F	SB7128	K003913	SB7463RC
II38343F	SB7138	K003912	SB7453RC
II38350F	SB7724	K003782	SN7195RC
II38350FAT		K003782	SN7195RC
II38351F	SB7734	K003781	SN7185RC
II38352F	SB7800	K003796	SN7199RC
II38352FAT		K003796	SN7199RC
II38353F	SB7810	K003795	SN7189RC
II38353FAT		K003795	SN7189RC
II38363F	SB7806	K003796	SN7199RC
II38364F	SB7816	K003795	SN7189RC
II38367F	SB7765	K003810	SN7216RC
II38368F	SB7775	K003809	SN7206RC
II38630F	SB7807	K002760	SB7415RC
II38631F	SB7817	K002759	SB7405RC
II38634F	SB7809	K002790	SB7431RC
II38635F	SB7819	K002789	SB7421RC

Dis Brake / Caliper Part No.	Dis Brake / Caliper Type No.	Rationalised Caliper Part No.	Rationalised Caliper Type No.
II38648F	SB7140	K002963	SB7460RC
II38648FAT		K002963	SB7460RC
II38649F	SB7150	K002962	SB7450RC
II38649FAT		K002962	SB7450RC
II38724F	SB7648	K003800	SN7211RC
II38725F	SB7658	K003799	SN7201RC
II38726F	SB7649	K003800	SN7211RC
II38726FAT		K003800	SN7211RC
II38727F	SB7659	K003799	SN7201RC
II38727FAT		K003799	SN7201RC
II38730F	SB7766	K002798	SB7432RC
II38731F	SB7776	K002797	SB7422RC
II38810F	SB7800	K003796	SN7199RC
II38810FAT		K003796	SN7199RC
II38811F	SB7810	K003795	SN7189RC
II38816F	SB7820	K003806	SN7214RC
II38817F	SB7830	K003805	SN7204RC
II39000F	SB7766	K002798	SB7432RC
II39000FAT		K002798	SB7432RC
II39001F	SB7776	K002797	SB7422RC
II39001FAT		K002797	SB7422RC
II39002F	SB7144	K002963	SB7460RC
II39003F	SB7154	K002962	SB7450RC
II39003FAT		K002962	SB7450RC
II39006F	SB7146	K002965	SB7461RC
II39006FAT		K002965	SB7461RC
II39007F	SB7156	K002964	SB7451RC
II39007FAT		K002964	SB7451RC
II39030F	SB7148	K002963	SB7460RC
II39031F	SB7158	K002962	SB7450RC
II39032F	SB7149	K002963	SB7460RC
II39033F	SB7159	K002962	SB7450RC
II39034F	SB7825	K003784	SN7196RC
II39035F	SB7835	K003783	SN7186RC
II39036F	SB6540	K003780	SN6563RC
II39036FAT		K003780	SN6563RC
II39037F	SB6550	K003779	SN6573RC
II39037FAT		K003779	SN6573RC
II39038F	SB6540	K003780	SN6563RC
II39039F	SB6550	K003779	SN6573RC
II39044F	SB7762	K003784	SN7196RC
II39044FAT		K003784	SN7196RC

Rationalised Calipers
Vereinheitlichte Zuspansseinheiten

Etriers Rationalisés
Pinze Razionalizzate

Dis Brake / Caliper Part No.	Dis Brake / Caliper Type No.	Rationalised Caliper Part No.	Rationalised Caliper Type No.
II39045F	SB7772	K003783	SN7186RC
II39045FAT		K003783	SN7186RC
II39046F	SB6520	K003780	SN6563RC
II39047F	SB6530	K003779	SN6573RC
II39048F	SB6528	K002923	SB6401RC
II39048FAT		K002923	SB6401RC
II39049F	SB6538	K002924	SB6411RC
II39049FAT		K002924	SB6411RC
II39068F	SB6545	K003826	SN6565RC
II39069F	SB6555	K003825	SN6555RC
II39251F	SB6546	K003826	SN6565RC
II39252F	SB6556	K003825	SN6555RC
II39252FAT		K003825	SN6555RC
II39258F	SB6547	K002919	SB6408RC
II39258FAT		K002919	SB6408RC
II39258FIV		K002919	SB6408RC
II39259F	SB6557	K002920	SB6418RC
II39259FAT		K002920	SB6418RC
II39259FIV		K002920	SB6418RC
II39262F	SB7826	K003810	SN7216RC
II39262FAT		K003810	SN7216RC
II39263F	SB7836	K003809	SN7206RC
II39264F	SB7724	K003782	SN7195RC
II39265F	SB7734	K003781	SN7185RC
II39266F	SB6548	K003780	SN6563RC
II39267F	SB6558	K003779	SN6573RC
II39274F	SB6549	K013176	SN6567RC
II39294F	SB7600	K003784	SN7196RC
II39544F	SB7828	K003806	SN7214RC
II39545F	SB7838	K003805	SN7204RC
II39842	SB7760	K003800	SN7211RC
II39843	SB7770	K003799	SN7201RC
II39848	SB7648	K003800	SN7211RC
II39848AT		K003800	SN7211RC
II39849	SB7658	K003799	SN7201RC
II39849AT		K003799	SN7201RC
II40232F	SB7865	K003796	SN7199RC
II40233F	SB7875	K003795	SN7189RC
K000002	SB7880	K003806	SN7214RC
K000003	SB7890	K003805	SN7204RC
K000005	SB6528	K002923	SB6401RC
K000005AT		K002923	SB6401RC

Dis Brake / Caliper Part No.	Dis Brake / Caliper Type No.	Rationalised Caliper Part No.	Rationalised Caliper Type No.
K000006	SB6538	K002924	SB6411RC
K000006AT		K002924	SB6411RC
K000007	SB7762	K003784	SN7196RC
K000007AT		K003784	SN7196RC
K000008	SB7772	K003783	SN7186RC
K000008AT		K003783	SN7186RC
K000011	SB7881	K003804	SN7332RC
K000012	SB7891	K003803	SN7322RC
K000032		K002963	SB7460RC
K000033		K002962	SB7450RC
K000035	SB7185	K002963	SB7460RC
K000035AT		K002963	SB7460RC
K000036	SB7195	K002962	SB7450RC
K000036AT		K002962	SB7450RC
K000037	SB7186	K002963	SB7460RC
K000038	SB7196	K002962	SB7450RC
K000039	SB7187	K002965	SB7461RC
K000040	SB7197	K002964	SB7451RC
K000041	SB7187	K002965	SB7461RC
K000042	SB7197	K002964	SB7451RC
K000043	SB7883	K003804	SN7332RC
K000044	SB7893	K003803	SN7322RC
K000045	SB7884	K003810	SN7216RC
K000046	SB7894	K003809	SN7206RC
K000051	SB7886	K003796	SN7199RC
K000051AT		K003796	SN7199RC
K000052	SB7896	K003795	SN7189RC
K000052AT		K003795	SN7189RC
K000053	SB7887	K003800	SN7211RC
K000053AT		K003800	SN7211RC
K000054	SB7897	K003799	SN7201RC
K000091	SB7801	K003782	SN7195RC
K000092	SB7811	K003781	SN7185RC
K000095	SB6527	K003780	SN6563RC
K000096	SB6537	K003779	SN6573RC
K000105	SB6548	K003780	SN6563RC
K000106	SB6558	K003779	SN6573RC
K000115	SB6548	K003780	SN6563RC
K000115AT		K003780	SN6563RC
K000116	SB6558	K003779	SN6573RC
K000116AT		K003779	SN6573RC
K000136	SB7900	K003784	SN7196RC

Dis Brake / Caliper Part No.	Dis Brake / Caliper Type No.	Rationalised Caliper Part No.	Rationalised Caliper Type No.
K000136AT		K003784	SN7196RC
K000137	SB7910	K003783	SN7186RC
K000137AT		K003783	SN7186RC
K000138	SB7901	K003782	SN7195RC
K000139	SB7911	K003781	SN7185RC
K000166	SB7188	K002963	SB7460RC
K000167	SB7198	K002962	SB7450RC
K000202	SN7020	K003796	SN7199RC
K000203	SN7030	K003795	SN7189RC
K000204	SN7020	K003796	SN7199RC
K000205	SN7030	K003795	SN7189RC
K000206	SN7022	K003796	SN7199RC
K000207	SN7032	K003795	SN7189RC
K000208	SN7022	K003796	SN7199RC
K000209	SN7032	K003795	SN7189RC
K000210	SB6566	K003780	SN6563RC
K000211	SB6576	K003779	SN6573RC
K000212	SB6566	K013174	SN6580RC
K000213	SB6576	K013173	SN6570RC
K000258	SB7200	K003913	SB7463RC
K000258AT		K003913	SB7463RC
K000258SC		K003913	SB7463RC
K000259	SB7210	K003912	SB7453RC
K000259AT		K003912	SB7453RC
K000259SC		K003912	SB7453RC
K000260	SB7902	K002562	SB7403RC
K000260AT		K002562	SB7403RC
K000260IV		K002562	SB7403RC
K000261	SB7912	K002561	SB7413RC
K000261AT		K002561	SB7413RC
K000261IV		K002561	SB7413RC
K000262	SB7189	K002967	SB7462RC
K000263	SB7199	K002966	SB7452RC
K000266	SN7045	K003804	SN7332RC
K000267	SN7055	K003803	SN7322RC
K000281	SN5001	K013474	SN5021RC
K000282	SN5011	K013473	SN5011RC
K000300	SB6567	K003780	SN6563RC
K000301	SB6577	K003779	SN6573RC
K000302	SN7022	K003798	SN7210RC
K000303	SN7032	K003797	SN7200RC
K000304	SN7022	K003798	SN7210RC

Dis Brake / Caliper Part No.	Dis Brake / Caliper Type No.	Rationalised Caliper Part No.	Rationalised Caliper Type No.
K000305	SN7032	K003797	SN7200RC
K000306	SN7020	K003798	SN7210RC
K000306AT		K003798	SN7210RC
K000307	SN7030	K003797	SN7200RC
K000307AT		K003797	SN7200RC
K000308	SN7020	K003798	SN7210RC
K000309	SN7030	K003797	SN7200RC
K000320	SB7904	K003784	SN7196RC
K000321	SB7914	K003783	SN7186RC
K000322	SB6521	K003780	SN6563RC
K000323	SB6531	K003779	SN6573RC
K000378	SB7607	K003804	SN7332RC
K000379	SB7617	K003803	SN7322RC
K000386	SB7880	K003806	SN7214RC
K000386AT		K003806	SN7214RC
K000387	SB7890	K003805	SN7204RC
K000387AT		K003805	SN7204RC
K000412	SB7906	K002709	SB7411RC
K000412AT		K002709	SB7411RC
K000412IV		K002709	SB7411RC
K000413	SB7916	K002708	SB7401RC
K000413AT		K002708	SB7401RC
K000413IV		K002708	SB7401RC
K000445	SN7029	K003782	SN7195RC
K000446	SN7039	K003781	SN7185RC
K000447	SN7029	K003782	SN7195RC
K000448	SN7039	K003781	SN7185RC
K000449	SN7029	K003782	SN7195RC
K000450	SN7039	K003781	SN7185RC
K000474	SN7066	K004579	SN7251RC
K000475	SN7076	K004578	SN7241RC
K000476	SN7067	K003782	SN7195RC
K000477	SN7077	K003781	SN7185RC
K000485	SB7201	K002963	SB7460RC
K000485AT		K002963	SB7460RC
K000486	SB7211	K002962	SB7450RC
K000486AT		K002962	SB7450RC
K000487	SB7621	K003810	SN7216RC
K000487AT		K003810	SN7216RC
K000488	SB7631	K003809	SN7206RC
K000488AT		K003809	SN7206RC
K000517	SB7903	K003782	SN7195RC

Rationalised Calipers
Vereinheitlichte Zuspansseinheiten

Etriers Rationalisés
Pinze Razionalizzate

Dis Brake / Caliper Part No.	Dis Brake / Caliper Type No.	Rationalised Caliper Part No.	Rationalised Caliper Type No.
K000517AT		K003782	SN7195RC
K000518	SB7913	K003781	SN7185RC
K000518AT		K003781	SN7185RC
K000550	SB7901	K003782	SN7195RC
K000551	SB7911	K003781	SN7185RC
K000552	SB7909	K003804	SN7332RC
K000553	SB7919	K003803	SN7322RC
K000584	SB6582	K002923	SB6401RC
K000584AT		K002923	SB6401RC
K000585	SB6592	K002924	SB6411RC
K000585AT		K002924	SB6411RC
K000605	SN7046	K003810	SN7216RC
K000606	SN7056	K003809	SN7206RC
K000715	SN6508	K003779	SN6573RC
K000716	SN6518	K003780	SN6563RC
K000719	SB7762	K003784	SN7196RC
K000719AT		K003784	SN7196RC
K000720	SB7772	K003783	SN7186RC
K000720AT		K003783	SN7186RC
K000771	SN7047	K003800	SN7211RC
K000772	SN7057	K003799	SN7201RC
K000773	SN7047	K003800	SN7211RC
K000774	SN7057	K003799	SN7201RC
K000775	SN7048	K003795	SN7189RC
K000776	SN7058	K003796	SN7199RC
K000778	SN7049	K003799	SN7201RC
K000779	SN7059	K003800	SN7211RC
K000780	SN7080	K003804	SN7332RC
K000781	SN7090	K003803	SN7322RC
K000782	SN7081	K003800	SN7211RC
K000782AT		K003800	SN7211RC
K000783	SN7091	K003799	SN7201RC
K000783AT		K003799	SN7201RC
K000786	SN7083	K003810	SN7216RC
K000787	SN7093	K003809	SN7206RC
K000790	SN7028	K003782	SN7195RC
K000791	SN7038	K013181	SN7300RC
K000815	SB7766	K002798	SB7432RC
K000815AT		K002798	SB7432RC
K000816	SB7776	K002797	SB7422RC
K000816AT		K002797	SB7422RC
K000822	SB7929	K003782	SN7195RC

Dis Brake / Caliper Part No.	Dis Brake / Caliper Type No.	Rationalised Caliper Part No.	Rationalised Caliper Type No.
K000823	SB7939	K003781	SN7185RC
K000826	SB7940	K003784	SN7196RC
K000827	SB7950	K003783	SN7186RC
K000830	SB7766	K002798	SB7432RC
K000831	SB7776	K002797	SB7422RC
K000849	SN7042	K013161	SN7299RC
K000850	SN7052	K013160	SN7289RC
K000851	SN7066	K004579	SN7251RC
K000852	SN7076	K004578	SN7241RC
K000870	SN7084	K003784	SN7196RC
K000870AT		K003784	SN7196RC
K000871	SN7094	K003783	SN7186RC
K000871AT		K003783	SN7186RC
K000872	SN7085	K003784	SN7196RC
K000873	SN7095	K003783	SN7186RC
K000993	SN7086	K003812	SN7217RC
K000994	SN7096	K003811	SN7207RC
K001038	SN7101	K003782	SN7195RC
K001039	SN7111	K003781	SN7185RC
K001051	SN7102	K003784	SN7196RC
K001051AT		K003784	SN7196RC
K001052	SN7112	K003783	SN7186RC
K001052AT		K003783	SN7186RC
K001054	SB6584	K003780	SN6563RC
K001055	SB6594	K003779	SN6573RC
K001077	SN7104	K003788	SN7198RC
K001078	SN7114	K003787	SN7188RC
K001079	SN6527	K013174	SN6580RC
K001079DC		K013174	SN6580RC
K001080	SN6537	K013173	SN6570RC
K001080DC		K013173	SN6570RC
K001081	SN6527	K003780	SN6563RC
K001082	SN6537	K003779	SN6573RC
K001083	SN6527	K013174	SN6580RC
K001084	SN6537	K013173	SN6570RC
K001085	SN6527	K013174	SN6580RC
K001086	SN6537	K013173	SN6570RC
K001087	SN6528	K013174	SN6580RC
K001088	SN6538	K013173	SN6570RC
K001089	SN6528	K013174	SN6580RC
K001090	SN6538	K013173	SN6570RC
K001091	SN6528	K013174	SN6580RC

Dis Brake / Caliper Part No.	Dis Brake / Caliper Type No.	Rationalised Caliper Part No.	Rationalised Caliper Type No.
K001092	SN6538	K013173	SN6570RC
K001093	SN6528	K013174	SN6580RC
K001094	SN6538	K013173	SN6570RC
K001115	SN7105	K003782	SN7195RC
K001116	SN7115	K003781	SN7185RC
K001117	SN6529	K003780	SN6563RC
K001118	SN6539	K003779	SN6573RC
K001140	SN7106	K003782	SN7195RC
K001141	SN7116	K003781	SN7185RC
K001142	SN7106	K003782	SN7195RC
K001143	SN7116	K003781	SN7185RC
K001164	SN7107	K003810	SN7216RC
K001164AT		K003810	SN7216RC
K001165	SN7117	K003809	SN7206RC
K001165AT		K003809	SN7206RC
K001169	SN7108	K003784	SN7196RC
K001170	SN7118	K003783	SN7186RC
K001175	SN6541	K013177	SN6558RC
K001176	SN6551	K013178	SN6568RC
K001177	SN6541	K013175	SN6557RC
K001177DC		K013175	SN6557RC
K001178	SN6551	K013176	SN6567RC
K001178DC		K013176	SN6567RC
K001216DC		K003800	SN7211RC
K001225	SN7121	K003806	SN7214RC
K001226	SN7131	K003805	SN7204RC
K001228	SB7942	K002965	SB7461RC
K001229	SB7952	K002964	SB7451RC
K001232	SN7122	K003810	SN7216RC
K001233	SN7132	K003809	SN7206RC
K001289	SN7123	K003784	SN7196RC
K001290	SN7133	K003783	SN7186RC
K001291	SN7124	K003782	SN7195RC
K001292	SN7134	K003781	SN7185RC
K001312	SN7125	K003816	SN7219RC
K001313	SN7135	K003815	SN7209RC
K001314	SN7126	K003816	SN7219RC
K001315	SN7136	K003815	SN7209RC
K001316	SN7127	K003812	SN7217RC
K001317	SN7137	K003811	SN7207RC
K001338	SN6542	K003780	SN6563RC
K001339	SN6552	K003779	SN6573RC

Dis Brake / Caliper Part No.	Dis Brake / Caliper Type No.	Rationalised Caliper Part No.	Rationalised Caliper Type No.
K001340	SN6543	K003780	SN6563RC
K001341	SN6553	K003779	SN6573RC
K001362	SB7948	K003800	SN7211RC
K001362AT		K003800	SN7211RC
K001363	SB7958	K003799	SN7201RC
K001363AT		K003799	SN7201RC
K001364	SB7948	K003800	SN7211RC
K001364AT		K003800	SN7211RC
K001365	SB7958	K003799	SN7201RC
K001365AT		K003799	SN7201RC
K001370	SN7129	K013182	SN7310RC
K001371	SN7139	K013181	SN7300RC
K001372	SN7140	K013184	SN7311RC
K001373	SN7150	K013183	SN7301RC
K001374	SN7141	K003784	SN7196RC
K001375	SN7151	K003783	SN7186RC
K001413	SN7142	K003782	SN7195RC
K001414	SN7152	K003781	SN7185RC
K001419	SN7081	K003800	SN7211RC
K001420	SN7091	K003799	SN7201RC
K001421	SN7081	K003800	SN7211RC
K001422	SN7091	K003799	SN7201RC
K001440	SN6545	K003800	SN7211RC
K001441	SN6555	K003799	SN7201RC
K001442	SN6546	K003780	SN6563RC
K001443	SN6556	K003779	SN6573RC
K001444	SN6547	K003780	SN6563RC
K001445	SN6557	K003779	SN6573RC
K001451	SN7143	K003784	SN7196RC
K001452	SN7153	K003783	SN7186RC
K001460	SB7960	K003804	SN7332RC
K001461	SB7970	K003803	SN7322RC
K001475	SN7144	K003800	SN7211RC
K001476	SN7154	K003799	SN7201RC
K001481	SK7026	K012633	SK7042RC
K001482	SK7036	K012634	SK7052RC
K001545	SN6507	K003780	SN6563RC
K001546	SN6517	K003779	SN6573RC
K001589	SB7202	K010810	SB7436RC
K001589SC		K010810	SB7436RC
K001590	SB7212	K010809	SB7426RC
K001590SC		K010809	SB7426RC

Rationalised Calipers
Vereinheitlichte Zuspansseinheiten

Etriers Rationalisés
Pinze Razionalizzate

Dis Brake / Caliper Part No.	Dis Brake / Caliper Type No.	Rationalised Caliper Part No.	Rationalised Caliper Type No.
K001591	SB7189	K002967	SB7462RC
K001591SC		K002967	SB7462RC
K001592	SB7199	K002966	SB7452RC
K001592SC		K002966	SB7452RC
K001593	SB7203	K002967	SB7462RC
K001594	SB7213	K002966	SB7452RC
K001654	SN7041	K003814	SN7218RC
K001654SC		K003814	SN7218RC
K001655	SN7051	K003813	SN7208RC
K001655SC		K003813	SN7208RC
K001660	SN7050	K003803	SN7322RC
K001747	SN5002	K004570	SN5005RC
K001747DC		K004570	SN5005RC
K001748	SN5012	K004571	SN5015RC
K001748DC		K004571	SN5015RC
K001749	SN5002	K004570	SN5005RC
K001750	SN5012	K004571	SN5015RC
K001751	SN5003	K004572	SN5006RC
K001751DC		K004572	SN5006RC
K001752	SN5013	K004573	SN5016RC
K001752DC		K004573	SN5016RC
K001753	SN5003	K004572	SN5006RC
K001754	SN5013	K004573	SN5016RC
K001763	SN6504	K013178	SN6568RC
K001764	SN6514	K013177	SN6558RC
K001765	SN6504	K013178	SN6568RC
K001766	SN6514	K013177	SN6558RC
K001767	SN6504	K013176	SN6567RC
K001768	SN6514	K013175	SN6557RC
K001769	SN6504	K013176	SN6567RC
K001770	SN6514	K013175	SN6557RC
K001908	SK7001	K012633	SK7042RC
K001909	SK7011	K012634	SK7052RC
K001942	SN5001	K005610	SN5023RC
K001943	SN5011	K005611	SN5033RC
K001944	SN5001	K005610	SN5023RC
K001945	SN5011	K005611	SN5033RC
K001949	SB7205	K002963	SB7460RC
K001950	SB7215	K002962	SB7450RC
K001951	SN7146	K003804	SN7332RC
K001952	SN7156	K003803	SN7322RC
K001953	SN7147	K003796	SN7199RC

Dis Brake / Caliper Part No.	Dis Brake / Caliper Type No.	Rationalised Caliper Part No.	Rationalised Caliper Type No.
K001954	SN7157	K003795	SN7189RC
K001955	SN6549	K003780	SN6563RC
K002010	SB7962	K016516	SN7318RC
K002011	SB7972	K016515	SN7308RC
K002012	SB7963	K005482	SB7456RC
K002012AT		K005482	SB7456RC
K002013	SB7973	K005481	SB7466RC
K002013AT		K005481	SB7466RC
K002057	SB7704	K003784	SN7196RC
K002058	SB7714	K003783	SN7186RC
K002059	SN6550	K013178	SN6568RC
K002059DC		K013178	SN6568RC
K002060	SN6560	K013177	SN6558RC
K002060DC		K013177	SN6558RC
K002061	SN6550	K013178	SN6568RC
K002062	SN6560	K013177	SN6558RC
K002063	SN6504	K013176	SN6567RC
K002063DC		K013176	SN6567RC
K002064	SN6514	K013175	SN6557RC
K002064DC		K013175	SN6557RC
K002065	SN6504	K013176	SN6567RC
K002066	SN6514	K013175	SN6557RC
K002099	SN7160	K003810	SN7216RC
K002100	SN7170	K003809	SN7206RC
K002107	SN6551	K003789	SN6554RC
K002108	SN6561	K003790	SN6564RC
K002118	SB7901	K003782	SN7195RC
K002119	SB7911	K003781	SN7185RC
K002142	SB6520	K003780	SN6563RC
K002142AT		K003780	SN6563RC
K002143	SB6530	K003779	SN6573RC
K002143AT		K003779	SN6573RC
K002144	SB7903	K003782	SN7195RC
K002145	SB7913	K003781	SN7185RC
K002167	SN7163	K003782	SN7195RC
K002168	SN7173	K003781	SN7185RC
K002222	SN7165	K013184	SN7311RC
K002223	SN7175	K013183	SN7301RC
K002246	SN7164	K003786	SN7197RC
K002247	SN7174	K003785	SN7187RC
K002306	SB7964	K003784	SN7196RC
K002307	SB7974	K003783	SN7186RC

Dis Brake / Caliper Part No.	Dis Brake / Caliper Type No.	Rationalised Caliper Part No.	Rationalised Caliper Type No.
K002337	SN7022	K003800	SN7211RC
K002338	SN7032	K003799	SN7201RC
K002339	SN7022	K003800	SN7211RC
K002340	SN7032	K003799	SN7201RC
K002341	SN7022	K003796	SN7199RC
K002342	SN7032	K003795	SN7189RC
K002343	SN7022	K003796	SN7199RC
K002344	SN7032	K003795	SN7189RC
K002345	SN7022	K003798	SN7210RC
K002346	SN7032	K003797	SN7200RC
K002347	SN7022	K003798	SN7210RC
K002348	SN7032	K003797	SN7200RC
K002349	SN7021	K003800	SN7211RC
K002350	SN7031	K003799	SN7201RC
K002351	SN7021	K003800	SN7211RC
K002352	SN7031	K003799	SN7201RC
K002353	SN7020	K003798	SN7210RC
K002354	SN7030	K003797	SN7200RC
K002355	SN7020	K003798	SN7210RC
K002355DC		K003798	SN7210RC
K002356	SN7030	K003797	SN7200RC
K002356DC		K003797	SN7200RC
K002357	SN7020	K003796	SN7199RC
K002358	SN7030	K003795	SN7189RC
K002359	SN7020	K003796	SN7199RC
K002360	SN7030	K003795	SN7189RC
K002361	SN7020	K003800	SN7211RC
K002362	SN7030	K003799	SN7201RC
K002363	SN7020	K003800	SN7211RC
K002363DC		K003800	SN7211RC
K002364	SN7030	K003799	SN7201RC
K002364DC		K003799	SN7201RC
K002375	SB7965	K002794	SB7430RC
K002376	SB7975	K002793	SB7420RC
K002444	SN7167	K003808	SN7215RC
K002444AT		K003808	SN7215RC
K002445	SN7177	K003807	SN7205RC
K002445AT		K003807	SN7205RC
K002446	SN7168	K003806	SN7214RC
K002446AT		K003806	SN7214RC
K002447	SN7178	K003805	SN7204RC
K002515	SN6552	K003780	SN6563RC

Dis Brake / Caliper Part No.	Dis Brake / Caliper Type No.	Rationalised Caliper Part No.	Rationalised Caliper Type No.
K002516	SN6562	K003779	SN6573RC
K002517	SN7183	K003786	SN7197RC
K002518	SN7193	K003785	SN7187RC
K002519 ¹⁾	SB5006	K004572	SN5006RC
K002520 ¹⁾	SB5016	K004573	SN5016RC
K002522	SN7169	K003796	SN7199RC
K002523	SN7179	K003795	SN7189RC
K002571	SN7086	K003812	SN7217RC
K002572	SN7096	K003811	SN7207RC
K002575	SN7126	K003816	SN7219RC
K002576	SN7136	K003815	SN7209RC
K002660	SN7102	K003784	SN7196RC
K002661	SN7112	K003783	SN7186RC
K002771	SB7406R	K003805	SN7204RC
K002772	SB7416R	K003806	SN7214RC
K002783	SB7408R	K003809	SN7206RC
K002784	SB7418R	K003810	SN7216RC
K002874	SB6400R	K003779	SN6573RC
K002875	SB6410R	K003780	SN6563RC
K002878	SB6404R	K003825	SN6555RC
K002879	SB6414R	K003826	SN6565RC
K002915	SB6403R	K003779	SN6573RC
K002916	SB6413R	K003780	SN6563RC
K002934	SN6529	K003780	SN6563RC
K002935	SN6539	K003779	SN6573RC
K002968	SB7453R	K003192	SB7455RC
K002969	SB7463R	K003193	SB7465RC
K002983	SN7107	K003810	SN7216RC
K002984	SN7117	K003809	SN7206RC
K003056	SN6545	K003780	SN6563RC
K003057	SN6555	K003779	SN6573RC
K003249AT		K003810	SN7216RC
K003250AT		K003809	SN7206RC
K003301	SN5001	K013473	SN5011RC
K003302	SN5011	K013474	SN5021RC
K003312	SN7166	K003796	SN7199RC
K003313	SN7176	K003795	SN7189RC
K003346	SN7081	K003800	SN7211RC
K003347	SN7091	K003799	SN7201RC
K003348	SN7081	K003800	SN7211RC
K003349	SN7091	K003799	SN7201RC
K003350	SN7081	K003800	SN7211RC

Rationalised Calipers
Vereinheitlichte Zuspansseinheiten

Etriers Rationalisés
Pinze Razionalizzate

Dis Brake / Caliper Part No.	Dis Brake / Caliper Type No.	Rationalised Caliper Part No.	Rationalised Caliper Type No.
K003350AT		K003800	SN7211RC
K003351	SN7091	K003799	SN7201RC
K003351AT		K003799	SN7201RC
K003352	SN7059	K003800	SN7211RC
K003353	SN7049	K003799	SN7201RC
K003386	SB7423R	K003809	SN7206RC
K003387	SB7433R	K003810	SN7216RC
K003400	SK7002	K012633	SK7042RC
K003401	SK7012	K012634	SK7052RC
K003402	SK7003	K012633	SK7042RC
K003403	SK7013	K012634	SK7052RC
K003453	SK7004	K012633	SK7042RC
K003454	SK7014	K012634	SK7052RC
K003455	SB7206	K002963	SB7460RC
K003456	SB7216	K002962	SB7450RC
K003662	SN6507	K003780	SN6563RC
K003662AT		K003780	SN6563RC
K003663	SN6517	K003779	SN6573RC
K003663AT		K003779	SN6573RC
K003664	SN7164	K003786	SN7197RC
K003665	SN7174	K003785	SN7187RC
K003666	SN7102	K003784	SN7196RC
K003667	SN7112	K003783	SN7186RC
K003668	SB6582	K002923	SB6401RC
K003669	SB6592	K002924	SB6411RC
K003670	SN7084	K003784	SN7196RC
K003671	SN7094	K003783	SN7186RC
K003672	SN6529	K003780	SN6563RC
K003673	SN6539	K003779	SN6573RC
K003715	SN6541	K013177	SN6558RC
K003715DC		K013177	SN6558RC
K003716	SN6551	K013178	SN6568RC
K003716DC		K013178	SN6568RC
K003717	SN6541	K013175	SN6557RC
K003717DC		K013175	SN6557RC
K003718	SN6551	K013176	SN6567RC
K003718DC		K013176	SN6567RC
K003791	SN6557R	K013175	SN6557RC
K003792	SN6567R	K013176	SN6567RC
K003793	SN6558R	K013177	SN6558RC
K003794	SN6568R	K013178	SN6568RC
K003801	SN7202R	K013160	SN7289RC

Dis Brake / Caliper Part No.	Dis Brake / Caliper Type No.	Rationalised Caliper Part No.	Rationalised Caliper Type No.
K003802	SN7212R	K013161	SN7299RC
K003830	SN7104	K003812	SN7217RC
K003831	SN7114	K003811	SN7207RC
K003849	SB7208	K005482	SB7456RC
K003850	SB7218	K005481	SB7466RC
K003852	SN7040	K003804	SN7332RC
K003852SC		K003804	SN7332RC
K003853	SN7050	K003803	SN7322RC
K003853SC		K003803	SN7322RC
K003856	SN6569	K013222	SN6605RC
K003857	SN6579	K013221	SN6595RC
K003860	SB7209	K002965	SB7461RC
K003861	SB7219	K002964	SB7451RC
K004161	SN6529	K003780	SN6563RC
K004162	SN6539	K003779	SN6573RC
K004276	SN7022	K003800	SN7211RC
K004277	SN7032	K003799	SN7201RC
K004278	SN7022	K003798	SN7210RC
K004279	SN7032	K003797	SN7200RC
K004481	SB6585	K003826	SN6565RC
K004482	SB6595	K003825	SN6555RC
K004483	SB6586	K003826	SN6565RC
K004484	SB6596	K003825	SN6555RC
K004496	SN7227	K003804	SN7332RC
K004497	SN7237	K003803	SN7322RC
K004526	SN6507	K003780	SN6563RC
K004527	SN6517	K003779	SN6573RC
K004545	SN7228	K010627	SN7275RC
K004546	SN7238	K010626	SN7265RC
K004547	SN7229	K003804	SN7332RC
K004548	SN7239	K003803	SN7322RC
K004549	SN7240	K003812	SN7217RC
K004550	SN7250	K003811	SN7207RC
K004580	SN7242R	K002561	SB7413RC
K004581	SN7252R	K002562	SB7403RC
K004623	SN7042	K013161	SN7299RC
K004624	SN7052	K013160	SN7289RC
K004625	SN7066	K004579	SN7251RC
K004626	SN7076	K004578	SN7241RC
K004674	SK7006	K012633	SK7042RC
K004675	SK7016	K012634	SK7052RC
K004733	SN5007	K004573	SN5016RC

Dis Brake / Caliper Part No.	Dis Brake / Caliper Type No.	Rationalised Caliper Part No.	Rationalised Caliper Type No.
K004734	SN5017	K004572	SN5006RC
K004758	SN6574	K013174	SN6580RC
K004759	SN6584	K013173	SN6570RC
K004804	SN7228	K010627	SN7275RC
K004805	SN7238	K010626	SN7265RC
K004854	SN7229	K003804	SN7332RC
K004855	SN7239	K003803	SN7322RC
K005020	SN7229	K003804	SN7332RC
K005021	SN7239	K003803	SN7322RC
K005037	SN7240	K003812	SN7217RC
K005038	SN7250	K003811	SN7207RC
K005077	SN7041	K003814	SN7218RC
K005078	SN7051	K003813	SN7208RC
K005079	SN7045	K003804	SN7332RC
K005080	SN7055	K003803	SN7322RC
K005504	SB7424R	K016515	SN7308RC
K005505	SB7434R	K016516	SN7318RC
K005713	SB7766	K002798	SB7432RC
K005714	SB7776	K002797	SB7422RC
K005757	SN7247	K003804	SN7332RC
K005758	SN7257	K003803	SN7322RC
K005759	SN7247	K003804	SN7332RC
K005760	SN7257	K003803	SN7322RC
K005968	SN6500	K009162	SN6566RC
K005969	SN6510	K009161	SN6556RC
K005970	SN6509	K009162	SN6566RC
K005971	SN6519	K009161	SN6556RC
K006430	SN7167	K003808	SN7215RC
K006430AT		K003808	SN7215RC
K006431	SN7177	K003807	SN7205RC
K006431AT		K003807	SN7205RC
K006432	SN7168	K003806	SN7214RC
K006432AT		K003806	SN7214RC
K006433	SN7178	K003805	SN7204RC
K006433AT		K003805	SN7204RC
K006539	SB7220	K010054	SB7435RC
K006540	SB7230	K010053	SB7425RC
K006605	SN7248	K003804	SN7332RC
K006606	SN7258	K003803	SN7322RC
K006843	SN6575	K003780	SN6563RC
K006843	SN6575	K013656	SN6572RC
K006844	SN6585	K003779	SN6573RC

Dis Brake / Caliper Part No.	Dis Brake / Caliper Type No.	Rationalised Caliper Part No.	Rationalised Caliper Type No.
K006844	SN6585	K013655	SN6582RC
K006872	SN7249	K003796	SN7199RC
K006873	SN7259	K003795	SN7189RC
K007088	SN7020	K003798	SN7210RC
K007089	SN7030	K003797	SN7200RC
K007090	SN7020	K003798	SN7210RC
K007090DC		K003798	SN7210RC
K007091	SN7030	K003797	SN7200RC
K007091DC		K003797	SN7200RC
K007092	SN7020	K003800	SN7211RC
K007093	SN7030	K003799	SN7201RC
K007094	SN7020	K003798	SN7210RC
K007095	SN7030	K003797	SN7200RC
K007096	SN7020	K003800	SN7211RC
K007097	SN7030	K003799	SN7201RC
K007098	SN7020	K003800	SN7211RC
K007098DC		K003800	SN7211RC
K007099	SN7030	K003799	SN7201RC
K007099DC		K003799	SN7201RC
K007151	SN7022	K003798	SN7210RC
K007152	SN7032	K003797	SN7200RC
K007153	SN7022	K003798	SN7210RC
K007154	SN7032	K003797	SN7200RC
K007156	SN7032	K003799	SN7201RC
K007159	SN7022	K003800	SN7211RC
K007160	SN7032	K003799	SN7201RC
K007187	SN7021	K003800	SN7211RC
K007188	SN7031	K003799	SN7201RC
K007189	SN7021	K003800	SN7211RC
K007190	SN7031	K003799	SN7201RC
K007765	SN7066	K004579	SN7251RC
K007766	SN7076	K004578	SN7241RC
K007767	SN7042	K013161	SN7299RC
K007767IV		K013161	SN7299RC
K007768	SN7052	K013160	SN7289RC
K007768IV		K013160	SN7289RC
K008168	SN7081	K003800	SN7211RC
K008169	SN7091	K003799	SN7201RC
K008170	SN7081	K003800	SN7211RC
K008171	SN7091	K003799	SN7201RC
K008172	SN7081	K003800	SN7211RC
K008172DC		K003800	SN7211RC

Rationalised Calipers
Vereinheitlichte Zuspansseinheiten

Etriers Rationalisés
Pinze Razionalizzate

Dis Brake / Caliper Part No.	Dis Brake / Caliper Type No.	Rationalised Caliper Part No.	Rationalised Caliper Type No.
K008173	SN7091	K003799	SN7201RC
K008173DC		K003799	SN7201RC
K008415	SB7222	K002963	SB7460RC
K008416	SB7232	K002962	SB7450RC
K008649	SB7221	K002967	SB7462RC
K008650	SB7231	K002966	SB7452RC
K008651	SB7189	K002967	SB7462RC
K008652	SB7199	K002966	SB7452RC
K008653	SB7202	K010810	SB7436RC
K008654	SB7212	K010809	SB7426RC
K009083	SN7041	K003814	SN7218RC
K009084	SN7051	K003813	SN7208RC
K009085	SN7040	K003804	SN7332RC
K009086	SN7050	K003803	SN7322RC
K009088	SN7055	K003803	SN7322RC
K009258	SN7260	K003804	SN7332RC
K009259	SN7270	K003803	SN7322RC
K009277	SN7183	K003786	SN7197RC
K009278	SN7193	K003785	SN7187RC
K009279	SN7084	K003784	SN7196RC
K009280	SN7094	K003783	SN7186RC
K009281	SN7164	K003786	SN7197RC
K009282	SN7174	K003785	SN7187RC
K009283	SN7102	K003784	SN7196RC
K009284	SN7112	K003783	SN7186RC
K009744	SK7004	K012633	SK7042RC
K009745	SK7014	K012634	SK7052RC
K009746	SK7001	K012633	SK7042RC
K009747	SK7011	K012634	SK7052RC
K009883	SN6550	K013178	SN6568RC
K009883DC		K013178	SN6568RC
K009884	SN6560	K013177	SN6558RC
K009884DC		K013177	SN6558RC
K009897	SB7202	K010810	SB7436RC
K009897SC		K010809	SB7426RC
K009898	SB7212	K010809	SB7426RC
K009898SC		K010810	SB7436RC
K009899	SB7202	K010810	SB7436RC
K009900	SB7212	K010809	SB7426RC
K009901	SB7221	K002967	SB7462RC
K009902	SB7231	K002966	SB7452RC
K009903	SB7189	K002967	SB7462RC

Dis Brake / Caliper Part No.	Dis Brake / Caliper Type No.	Rationalised Caliper Part No.	Rationalised Caliper Type No.
K009903SC		K002967	SB7462RC
K009904	SB7199	K002966	SB7452RC
K009904SC		K002966	SB7452RC
K009910	SN6550	K013178	SN6568RC
K009911	SN6560	K013177	SN6558RC
K009912	SN6504	K013176	SN6567RC
K009913	SN6514	K013175	SN6557RC
K009914	SN6504	K013176	SN6567RC
K009914DC		K013176	SN6567RC
K009915	SN6514	K013175	SN6557RC
K009915DC		K013175	SN6557RC
K009965	SN7263	K004579	SN7251RC
K009966	SN7273	K004578	SN7241RC
K010114	SN7260	K003804	SN7332RC
K010115	SN7270	K003803	SN7322RC
K010147	SN7021	K003800	SN7211RC
K010148	SN7031	K003799	SN7201RC
K010149	SN7022	K003800	SN7211RC
K010150	SN7032	K003799	SN7201RC
K010151	SN7022	K003798	SN7210RC
K010152	SN7032	K003797	SN7200RC
K010153	SN7086	K003812	SN7217RC
K010154	SN7096	K003811	SN7207RC
K010155	SN7264	K003813	SN7208RC
K010155SC		K003813	SN7208RC
K010156	SN7274	K003814	SN7218RC
K010156SC		K003814	SN7218RC
K010164	SB7185	K002963	SB7460RC
K010165	SB7195	K002962	SB7450RC
K010166	SB7208	K005482	SB7456RC
K010166AT		K005482	SB7456RC
K010167	SB7218	K005481	SB7466RC
K010167AT		K005481	SB7466RC
K010168	SB7225	K002963	SB7460RC
K010169	SB7235	K002962	SB7450RC
K010170	SB7942	K002965	SB7461RC
K010171	SB7952	K002964	SB7451RC
K010172	SB7187	K002965	SB7461RC
K010173	SB7197	K002964	SB7451RC
K010277	SK7007	K012633	SK7042RC
K010277DC		K012633	SK7042RC
K010278	SK7017	K012634	SK7052RC

Dis Brake / Caliper Part No.	Dis Brake / Caliper Type No.	Rationalised Caliper Part No.	Rationalised Caliper Type No.
K010278DC		K012634	SK7052RC
K010650	SB7509	K002965	SB7461RC
K010651	SB7519	K002964	SB7451RC
K010652	SB7201	K002963	SB7460RC
K010653	SB7211	K002962	SB7450RC
K010654	SB7209	K002965	SB7461RC
K010655	SB7219	K002964	SB7451RC
K010656	SB7220	K010054	SB7435RC
K010657	SB7230	K010053	SB7425RC
K010658	SB7222	K002963	SB7460RC
K010658AT		K002963	SB7460RC
K010659	SB7232	K002962	SB7450RC
K010659AT		K002962	SB7450RC
K010694	SN5003	K011125	SN5020RC
K010695	SN5013	K011126	SN5030RC
K010743	SN7322R	K003803	SN7322RC
K010744	SN7332R	K003804	SN7332RC
K010749	SN7160	K003810	SN7216RC
K010750	SN7170	K003809	SN7206RC
K010791	SN5003	K004572	SN5006RC
K010792	SN5013	K004573	SN5016RC
K010793	SN5002	K004570	SN5005RC
K010794	SN5012	K004571	SN5015RC
K010897	SN7021	K003798	SN7210RC
K010898	SN7031	K003797	SN7200RC
K010899	SN7021	K003798	SN7210RC
K010900	SN7031	K003797	SN7200RC
K010901	SN7021	K003798	SN7210RC
K010902	SN7031	K003797	SN7200RC
K011130	SN7266	K003800	SN7211RC
K011131	SN7276	K003799	SN7201RC
K011132	SN7266	K003800	SN7211RC
K011133	SN7276	K003799	SN7201RC
K011134	SN7047	K003800	SN7211RC
K011135	SN7057	K003799	SN7201RC
K011136	SN7047	K003800	SN7211RC
K011137	SN7057	K003799	SN7201RC
K011138	SN7107	K003810	SN7216RC
K011139	SN7117	K003809	SN7206RC
K011140	SN7107	K003810	SN7216RC
K011141	SN7117	K003809	SN7206RC
K011170	SN7085	K003784	SN7196RC

Dis Brake / Caliper Part No.	Dis Brake / Caliper Type No.	Rationalised Caliper Part No.	Rationalised Caliper Type No.
K011171	SN7095	K003783	SN7186RC
K011172	SN7123	K003784	SN7196RC
K011173	SN7133	K003783	SN7186RC
K011174	SN7101	K003782	SN7195RC
K011175	SN7111	K003781	SN7185RC
K011176	SN7067	K003782	SN7195RC
K011177	SN7077	K003781	SN7185RC
K011178	SN5001	K005610	SN5023RC
K011179	SN5011	K005611	SN5033RC
K011180	SN5001	K005610	SN5023RC
K011181	SN5011	K005611	SN5033RC
K011237	SN5001	K005610	SN5023RC
K011238	SN5011	K005611	SN5033RC
K011239	SN5011	K013473	SN5011RC
K011240	SN5001	K013474	SN5021RC
K011257	SN5013	K004573	SN5016RC
K011258	SN5003	K004572	SN5006RC
K011259	SN5013	K004573	SN5016RC
K011259DC		K004573	SN5016RC
K011260	SN5003	K004572	SN5006RC
K011260DC		K004572	SN5006RC
K011261	SN5012	K004571	SN5015RC
K011262	SN5002	K004570	SN5005RC
K011263	SN5012	K004571	SN5015RC
K011263DC		K004571	SN5015RC
K011264	SN5002	K004570	SN5005RC
K011264DC		K004570	SN5005RC
K011294	SN7267	K003810	SN7216RC
K011295	SN7277	K003809	SN7206RC
K011296	SN7268	K003784	SN7196RC
K011297	SN7278	K003783	SN7186RC
K011298	SN7269	K003784	SN7196RC
K011298AT		K003784	SN7196RC
K011299	SN7279	K003783	SN7186RC
K011299AT		K003783	SN7186RC
K011300	SN7280	K003800	SN7211RC
K011301	SN7290	K003799	SN7201RC
K011302	SN7281	K003782	SN7195RC
K011303	SN7291	K003781	SN7185RC
K011304	SN7282	K003782	SN7195RC
K011304AT		K003782	SN7195RC
K011305	SN7292	K003781	SN7185RC

Rationalised Calipers
Vereinheitlichte Zuspansseinheiten

Etriers Rationalisés
Pinze Razionalizzate

Dis Brake / Caliper Part No.	Dis Brake / Caliper Type No.	Rationalised Caliper Part No.	Rationalised Caliper Type No.
K011305AT		K003781	SN7185RC
K011309	SN7283	K004579	SN7251RC
K011310	SN7293	K004578	SN7241RC
K011311	SB7226	K002963	SB7460RC
K011312	SB7236	K002962	SB7450RC
K011391	SN7168	K003806	SN7214RC
K011392	SN7178	K003805	SN7204RC
K011537	SN6577	K003828	SN6620RC
K011538	SN6587	K003827	SN6610RC
K011539	SN6578	K003780	SN6563RC
K011540	SN6588	K003779	SN6573RC
K011541	SN6590	K003780	SN6563RC
K011542	SN6600	K003779	SN6573RC
K011545	SK7028	K012633	SK7042RC
K011546	SK7038	K012634	SK7052RC
K011547	SK7029	K012633	SK7042RC
K011548	SK7039	K012634	SK7052RC
K011549	SN5021	K004571	SN5015RC
K011550	SN5031	K004570	SN5005RC
K011551	SN5022	K011126	SN5030RC
K011552	SN5032	K011125	SN5020RC
K011666	SN7080	K003804	SN7332RC
K011667	SN7090	K003803	SN7322RC
K011668	SN7122	K003810	SN7216RC
K011669	SN7132	K003809	SN7206RC
K011670	SN7160	K003810	SN7216RC
K011670AT		K003810	SN7216RC
K011671	SN7170	K003809	SN7206RC
K011671AT		K003809	SN7206RC
K011672	SN7249	K003796	SN7199RC
K011673	SN7259	K003795	SN7189RC
K011700	SN7284	K003806	SN7214RC
K011701	SN7294	K003805	SN7204RC
K011702	SN7285	K003798	SN7210RC
K011703	SN7295	K003797	SN7200RC
K011796	SN6500	K009162	SN6566RC
K011797	SN6510	K009161	SN6556RC
K011872	SN7087	K003810	SN7216RC
K011873	SN7097	K003809	SN7206RC
K012001	SB7227	K002963	SB7460RC
K012002	SB7237	K002962	SB7450RC
K012003	SB7227	K002963	SB7460RC

Dis Brake / Caliper Part No.	Dis Brake / Caliper Type No.	Rationalised Caliper Part No.	Rationalised Caliper Type No.
K012004	SB7237	K002962	SB7450RC
K012005	SB7228	K014066	SB7239RC
K012006	SB7238	K014065	SB7229RC
K012007	SB7228	K014066	SB7239RC
K012008	SB7238	K014065	SB7229RC
K012009	SN7287	K003806	SN7214RC
K012010	SN7297	K003805	SN7204RC
K012276	SB7220	K010054	SB7435RC
K012276AT		K010054	SB7435RC
K012276SC		K010054	SB7435RC
K012277	SB7230	K010053	SB7425RC
K012277AT		K010053	SB7425RC
K012277SC		K010053	SB7425RC
K012278	SB7222	K002963	SB7460RC
K012278AT		K002963	SB7460RC
K012278SC		K002963	SB7460RC
K012279	SB7232	K002962	SB7450RC
K012279AT		K002962	SB7450RC
K012279SC		K002962	SB7450RC
K012341	SK7041	K012633	SK7042RC
K012342	SK7051	K012634	SK7052RC
K012343	SN7288	K003784	SN7196RC
K012344	SN7298	K003783	SN7186RC
K012345	SN6592	K003780	SN6563RC
K012346	SN6602	K003779	SN6573RC
K012731	SN6541	K013177	SN6558RC
K012732	SN6551	K013178	SN6568RC
K012733	SN6589	K013175	SN6557RC
K012734	SN6599	K013176	SN6567RC
K013152	SN6594	K013656	SN6572RC
K013153	SN6604	K013655	SN6582RC
K013154	SN6594	K013656	SN6572RC
K013155	SN6604	K013655	SN6582RC
K013203	SN6581R	K003779	SN6573RC
K013204	SN6571R	K003780	SN6563RC
K013328	SN7304	K003800	SN7211RC
K013329	SN7314	K003799	SN7201RC
K013576	SN6596	K013656	SN6572RC
K013577	SN6606	K013655	SN6582RC
K013592	SN7108	K003784	SN7196RC
K013593	SN7118	K003783	SN7186RC
K013807	SN7142	K003782	SN7195RC

Dis Brake / Caliper Part No.	Dis Brake / Caliper Type No.	Rationalised Caliper Part No.	Rationalised Caliper Type No.
K013808	SN7152	K003781	SN7185RC
K013818	SN6551	K003789	SN6554RC
K013818IV		K003789	SN6554RC
K013819	SN6561	K003790	SN6564RC
K013819IV		K003790	SN6564RC
K013869	SN6546	K003780	SN6563RC
K013870	SN6556	K003779	SN6573RC
K013871	SN6547	K003780	SN6563RC
K013872	SN6557	K003779	SN6573RC
K013873	SK7002	K012633	SK7042RC
K013874	SK7012	K012634	SK7052RC
K013879	SN7105	K003782	SN7195RC
K013880	SN7115	K003781	SN7185RC
K013883	SN7106	K003782	SN7195RC
K013884	SN7116	K003781	SN7185RC
K013885	SN7129	K013182	SN7310RC
K013886	SN7139	K013181	SN7300RC
K013887	SN7140	K013184	SN7311RC
K013888	SN7150	K013183	SN7301RC
K013889	SN7141	K013184	SN7311RC
K013890	SN7151	K013183	SN7301RC
K013891	SN7163	K003782	SN7195RC
K013892	SN7173	K003781	SN7185RC
K014334	SN7029	K003782	SN7195RC
K014335	SN7039	K003781	SN7185RC
K014336	SN7029	K003782	SN7195RC
K014337	SN7039	K003781	SN7185RC
K014338	SN7029	K003782	SN7195RC
K014339	SN7039	K003781	SN7185RC
K014344	SN7260	K003804	SN7332RC
K014345	SN7270	K003803	SN7322RC
K014513	SN6597	K013656	SN6572RC
K014514	SN6607	K013655	SN6582RC
K014522	SN7307	K010627	SN7275RC
K014523	SN7317	K010626	SN7265RC
K014651	SN7144	K003800	SN7211RC
K014652	SN7154	K003799	SN7201RC
K014653	SN7144	K003800	SN7211RC
K014653AT		K003800	SN7211RC
K014654	SN7154	K003799	SN7201RC
K014654AT		K003799	SN7201RC
K014655	SN7169	K003796	SN7199RC

Dis Brake / Caliper Part No.	Dis Brake / Caliper Type No.	Rationalised Caliper Part No.	Rationalised Caliper Type No.
K014655AT		K003796	SN7199RC
K014656	SN7179	K003795	SN7189RC
K014656AT		K003795	SN7189RC
K014935	SN6507	K003780	SN6563RC
K014936	SN6517	K003779	SN6573RC
K014937	SN6507	K003780	SN6563RC
K014938	SN6517	K003779	SN6573RC
K014939	SN6529	K003780	SN6563RC
K014940	SN6539	K003779	SN6573RC
K014941	SN6552	K003780	SN6563RC
K014942	SN6562	K003779	SN6573RC
K014987	SN7086	K003812	SN7217RC
K014988	SN7096	K003811	SN7207RC
K014989	SN7127	K003812	SN7217RC
K014990	SN7137	K003811	SN7207RC
K014991	SN7086	K003812	SN7217RC
K014992	SN7096	K003811	SN7207RC
K014993	SN7247	K003804	SN7332RC
K014994	SN7257	K003803	SN7322RC
K014995	SN7247	K003804	SN7332RC
K014996	SN7257	K003803	SN7322RC
K014997	SN7086	K003812	SN7217RC
K014998	SN7096	K003811	SN7207RC
K014999	SN7125	K003816	SN7219RC
K015000	SN7135	K003815	SN7209RC
K015001	SN7126	K003816	SN7219RC
K015002	SN7136	K003815	SN7209RC
K015003	SN7126	K003816	SN7219RC
K015004	SN7136	K003815	SN7209RC
K015005	SN7228	K010627	SN7275RC
K015006	SN7238	K010626	SN7265RC
K015007	SN7228	K010627	SN7275RC
K015008	SN7238	K010626	SN7265RC
K015009	SN7240	K003812	SN7217RC
K015010	SN7250	K003811	SN7207RC
K015013	SN7229	K003804	SN7332RC
K015014	SN7239	K003803	SN7322RC
K015015	SN7229	K003804	SN7332RC
K015016	SN7239	K003803	SN7322RC
K015086	SK7009	K012633	SK7042RC
K015087	SK7019	K012634	SK7052RC
K015234	SN7080	K003804	SN7332RC

Rationalised Calipers
Vereinheitlichte Zuspansseinheiten

Etriers Rationalisés
Pinze Razionalizzate

Dis Brake / Caliper Part No.	Dis Brake / Caliper Type No.	Rationalised Caliper Part No.	Rationalised Caliper Type No.
K015234AT		K003804	SN7332RC
K015235	SN7090	K003803	SN7322RC
K015235AT		K003803	SN7322RC
K015425	SN7028	K003782	SN7195RC
K015426	SN7038	K003781	SN7185RC
K015427	SN7028	K003782	SN7195RC
K015428	SN7038	K003781	SN7185RC
K015429	SN7028	K003782	SN7195RC
K015430	SN7038	K003781	SN7185RC
K015557	SN7324	K016516	SN7318RC
K015558	SN7334	K016515	SN7308RC
K015559	SN7323	K003784	SN7196RC
K015560	SN7333	K003783	SN7186RC
K015804DC	SN6550	K013178	SN6568RC
K015805DC	SN6560	K013177	SN6558RC
K015806DC	SN6504	K013176	SN6567RC
K015807DC	SN6514	K013175	SN6557RC
K015972	SN5001	K005610	SN5023RC
K015973	SN5011	K005611	SN5033RC
K016524	SN7309	K026764	SN7376RC
K016524DC		K026764	SN7376RC
K016525	SN7319	K026763	SN7366RC
K016525DC		K026763	SN7366RC
K016526	SN7309	K026764	SN7376RC
K016527	SN7319	K026763	SN7366RC
K016528	SN7309	K026764	SN7376RC
K016529	SN7319	K026763	SN7366RC
K016618	SN5001	K005610	SN5023RC
K016619	SN5011	K005611	SN5033RC
K016620	SN5011	K005611	SN5033RC
K016621	SN5001	K005610	SN5023RC
K016622	SN5001	K013474	SN5021RC
K016623	SN5011	K013473	SN5011RC
K016626	SN5001	K005610	SN5023RC
K016627	SN5011	K005611	SN5033RC
K016811	SN7263	K004579	SN7251RC
K016812	SN7273	K004578	SN7241RC
K016813	SN7169	K003796	SN7199RC
K016814	SN7179	K003795	SN7189RC
K016827	SN7066	K004579	SN7251RC
K016828	SN7076	K004578	SN7241RC
K016829	SN7042	K013161	SN7299RC

Dis Brake / Caliper Part No.	Dis Brake / Caliper Type No.	Rationalised Caliper Part No.	Rationalised Caliper Type No.
K016830	SN7052	K013160	SN7289RC
K017172	SN6500	K009162	SN6566RC
K017173	SN6510	K009161	SN6556RC
K017195	SN7329	K003804	SN7332RC
K017196	SN7339	K003803	SN7322RC
K017395	SN7283	K003796	SN7199RC
K017396	SN7293	K003795	SN7189RC
K017477	SN7340	K016516	SN7318RC
K017478	SN7350	K016515	SN7308RC
K017479	SN7341	K016516	SN7318RC
K017480	SN7351	K016515	SN7308RC
K019013	SN6507	K003780	SN6563RC
K019014	SN6517	K003779	SN6573RC
K019136	SN7042	K013161	SN7299RC
K019137	SN7052	K013160	SN7289RC
K019417	SN7346	K013161	SN7299RC
K019418	SN7356	K013160	SN7289RC
K019562	SN7348	K003804	SN7332RC
K019563	SN7358	K003803	SN7322RC
K019759	SN7347	K003804	SN7332RC
K019760	SN7357	K003803	SN7322RC
K021666	SK7025	K012633	SK7042RC
K021667	SK7035	K012634	SK7052RC
K023210	SB7227	K002963	SB7460RC
K023211	SB7237	K002962	SB7450RC
K023558	SN7361	K003800	SN7211RC
K023559	SN7371	K003799	SN7201RC
K023627	SB7966	K002963	SB7460RC
K023628	SB7976	K002962	SB7450RC
K023629	SN7362	K003796	SN7199RC
K023630	SN7372	K003795	SN7189RC
K023735	SN7067	K003782	SN7195RC
K023736	SN7077	K003781	SN7185RC
K023796	SK7009	K012633	SK7042RC
K023797	SK7019	K012634	SK7052RC
K024731	SN6628	K013176	SN6567RC
K024732	SN6638	K013175	SN6557RC
K024733	SN6629	K013176	SN6567RC
K024734	SN6639	K013175	SN6557RC
K024735	SN6630	K013178	SN6568RC
K024736	SN6640	K013177	SN6558RC
K024737	SN6631	K013178	SN6568RC

Dis Brake / Caliper Part No.	Dis Brake / Caliper Type No.	Rationalised Caliper Part No.	Rationalised Caliper Type No.
K024738	SN6641	K013177	SN6558RC
K025626	SN6551	K003789	SN6554RC
K025627	SN6561	K003790	SN6564RC
K028024	SK7025	K012633	SK7042RC
K028025	SK7035	K012634	SK7052RC
K028143	SN7367	K010627	SN7275RC
K028144	SN7377	K010626	SN7265RC
K029098		K003786	SN7197RC
K029099		K003785	SN7187RC
K029100		K003786	SN7197RC
K029101		K003785	SN7187RC
K031426	SN7041	K003814	SN7218RC
K031427	SN7051	K003813	SN7208RC
K031428	SN7264	K003813	SN7208RC
K031429	SN7274	K003814	SN7218RC
K031430	SN7040	K003804	SN7332RC
K031431	SN7050	K003803	SN7322RC
K031432	SN7260	K003804	SN7332RC
K031433	SN7270	K003803	SN7322RC
K031434	SN7045	K003804	SN7332RC
K031435	SN7055	K003803	SN7322RC
K031436	SB7221	K002967	SB7462RC
K031437	SB7231	K002966	SB7452RC
K031438	SB7189	K002967	SB7462RC
K031439	SB7199	K002966	SB7452RC
K031440	SB7202	K010810	SB7436RC
K031441	SB7212	K010809	SB7426RC
K031442	SB7202	K010810	SB7436RC
K031443	SB7212	K010809	SB7426RC
K032543	SB7220	K010054	SB7435RC
K032544	SB7230	K010053	SB7425RC
K032585	SN6541	K013177	SN6558RC
K032586	SN6551	K013178	SN6568RC
K035432		K003784	SN7196RC
K035433		K003783	SN7186RC
K036798	SN7400	K003788	SN7198RC
K036799	SN7410	K003787	SN7188RC
K039468	SN7264	K003813	SN7208RC
K040911	SN6577	K003828	SN6620RC
K040912	SN6587	K003827	SN6610RC
K041454	SN7405	K003804	SN7332RC
K041455	SN7415	K003803	SN7322RC

Dis Brake / Caliper Part No.	Dis Brake / Caliper Type No.	Rationalised Caliper Part No.	Rationalised Caliper Type No.
K045318	SN7041	K003814	SN7218RC
K045319	SN7051	K003813	SN7208RC
K045322	SN7040	K003804	SN7332RC
K045323	SN7050	K003803	SN7322RC
K045324	SN7045	K003804	SN7332RC
K045325	SN7055	K003803	SN7322RC
K047412	SB7187	K002965	SB7461RC
K047413	SB7197	K002964	SB7451RC
Z0001651	SB7501	K003804	SN7332RC
Z0001652	SB7511	K003803	SN7322RC
Z000276	SB7829	K002760	SB7415RC
Z000277	SB7839	K002759	SB7405RC
Z000652	SB7688	K002786	SB7419RC
Z000652AT		K002786	SB7419RC
Z000653	SB7698	K002785	SB7409RC
Z000653AT		K002785	SB7409RC
Z000723	SN7020	K003800	SN7211RC
Z000723AT		K003800	SN7211RC
Z000724	SN7030	K003799	SN7201RC
Z000724AT		K003799	SN7201RC
Z000725	SN7020	K003800	SN7211RC
Z000726	SN7030	K003799	SN7201RC
Z0009751	SB7859	K003806	SN7214RC
Z0009752	SB7869	K003805	SN7204RC
Z0009801	SB7858	K002798	SB7432RC
Z0009802	SB7868	K002797	SB7422RC
Z000981	SB7824	K002798	SB7432RC
Z000982	SB7834	K002797	SB7422RC
Z0010001	SN7021	K003800	SN7211RC
Z0010002	SN7031	K003799	SN7201RC
Z0010003	SN7021	K003800	SN7211RC
Z0010004	SN7031	K003799	SN7201RC
Z0010291	SN7022	K003800	SN7211RC
Z0010292	SN7032	K003799	SN7201RC
Z0010293	SN7022	K003800	SN7211RC
Z0010294	SN7032	K003799	SN7201RC
Z0010671	SB6561	K003780	SN6563RC
Z0010672	SB6571	K003779	SN6573RC
Z0010911	SN7028	K003782	SN7195RC
Z0010911AT		K003782	SN7195RC
Z0010911DC		K003782	SN7195RC
Z0010912	SN7038	K003781	SN7185RC

Rationalised Calipers
Vereinheitlichte Zuspansseinheiten

Etriers Rationalisés
Pinze Razionalizzate

Dis Brake / Caliper Part No.	Dis Brake / Caliper Type No.	Rationalised Caliper Part No.	Rationalised Caliper Type No.
Z0010912DC		K003781	SN7185RC
Z0010913	SN7028	K003782	SN7195RC
Z0010914	SN7038	K003781	SN7185RC
Z0010961	SB7842	K002965	SB7461RC
Z0010962	SB7852	K002964	SB7451RC
Z0011451	SB6527	K003780	SN6563RC
Z0011452	SB6537	K003779	SN6573RC
Z0011471	SB7767	K003784	SN7196RC
Z0011471AT		K003784	SN7196RC
Z0011472	SB7777	K003783	SN7186RC
Z0011472AT		K003783	SN7186RC
Z0011491	SB7801	K003782	SN7195RC
Z0011491AT		K003782	SN7195RC
Z0011492	SB7811	K003781	SN7185RC
Z0011492AT		K003781	SN7185RC
Z0011541	SB6548	K003780	SN6563RC
Z0011542	SB6558	K003779	SN6573RC
Z0011561	SB6528	K002923	SB6401RC
Z0011561AT		K002923	SB6401RC
Z0011562	SB6538	K002924	SB6411RC
Z0011562AT		K002924	SB6411RC
Z0011581	SB7762	K003784	SN7196RC
Z0011582	SB7772	K003783	SN7186RC
Z0011891	SB6543	K013178	SN6568RC
Z0011892	SB6553	K013177	SN6558RC
Z0013571	SB7888	K003804	SN7332RC
Z0013571AT		K003804	SN7332RC
Z0013572	SB7898	K003803	SN7322RC
Z0013572AT		K003803	SN7322RC
Z0013591	SB7889	K003810	SN7216RC
Z0013591AT		K003810	SN7216RC
Z0013591SAT		K003810	SN7216RC
Z0013592	SB7899	K003809	SN7206RC
Z0013592AT		K003809	SN7206RC
Z0013592SAT		K003809	SN7206RC
Z0013611	SN7040	K003804	SN7332RC
Z0013612	SN7050	K003803	SN7322RC
Z0015241	SB7601	K002709	SB7411RC
Z0015241AT		K002709	SB7411RC
Z0015242	SB7611	K002708	SB7401RC
Z0015242AT		K002708	SB7401RC
Z0015261	SB7602	K002562	SB7403RC

Dis Brake / Caliper Part No.	Dis Brake / Caliper Type No.	Rationalised Caliper Part No.	Rationalised Caliper Type No.
Z0015261AT		K002562	SB7403RC
Z0015262	SB7612	K002561	SB7413RC
Z0015262AT		K002561	SB7413RC
Z0015711	SB7860	K003803	SN7322RC
Z0015712	SB7870	K003804	SN7332RC
Z0015712AT		K003804	SN7332RC
Z0015731	SB7861	K002760	SB7415RC
Z0015732		K002759	SB7405RC
Z0015751	SB7862	K003810	SN7216RC
Z0015752	SB7872	K003809	SN7206RC
Z0016511	SB6527	K003780	SN6563RC
Z0016511AT		K003780	SN6563RC
Z0016512	SB6537	K003779	SN6573RC
Z0016512AT		K003779	SN6573RC
Z0016513AT		K003780	SN6563RC
Z0016514AT		K003779	SN6573RC
Z0016571	SB7679	K002794	SB7430RC
Z0016571AT		K002794	SB7430RC
Z0016572	SB7689	K002793	SB7420RC
Z0016572AT		K002793	SB7420RC
Z0017261	SN7042	K013161	SN7299RC
Z0017262	SN7052	K013160	SN7289RC
Z0017521	SB7800	K003782	SN7195RC
Z0017521AT		K003782	SN7195RC
Z0017522	SB7810	K003781	SN7185RC
Z0017522AT		K003781	SN7185RC
Z0017523	SB7800	K003782	SN7195RC
Z0017523AT		K003782	SN7195RC
Z0017524	SB7810	K003781	SN7185RC
Z0017524AT		K003781	SN7185RC
Z0017671	SB6548	K003780	SN6563RC
Z0017672	SB6558	K003779	SN6573RC
Z0017951	SB7863	K003804	SN7332RC
Z0017952	SB7873	K003803	SN7322RC
Z0017971	SB6563	K003826	SN6565RC
Z0017972	SB6573	K003825	SN6555RC
Z0021001	SB7604	K003804	SN7332RC
Z0021001AT		K003804	SN7332RC
Z0021002	SB7614	K003803	SN7322RC
Z0021002AT		K003803	SN7322RC
Z0021021	SB7607	K003804	SN7332RC
Z0021021AT		K003804	SN7332RC

Dis Brake / Caliper Part No.	Dis Brake / Caliper Type No.	Rationalised Caliper Part No.	Rationalised Caliper Type No.
Z0021022	SB7617	K003803	SN7322RC
Z0021022AT		K003803	SN7322RC
Z0021041	SB7608	K003804	SN7332RC
Z0021041AT		K003804	SN7332RC
Z0021042	SB7618	K003803	SN7322RC
Z0021042AT		K003803	SN7322RC
Z0021043	SB7608	K003804	SN7332RC
Z0021044	SB7618	K003803	SN7322RC
Z0021081	SB7621	K003810	SN7216RC
Z0021082	SB7631	K003809	SN7206RC
Z0021082AT		K003809	SN7206RC
Z0021103	SB7168	K002963	SB7460RC
Z0021103AT		K002963	SB7460RC
Z0021104	SB7178	K002962	SB7450RC
Z0021104AT		K002962	SB7450RC
Z0021121	SB7180	K002965	SB7461RC
Z0021121AT		K002965	SB7461RC
Z0021122	SB7190	K002964	SB7451RC
Z0021122AT		K002964	SB7451RC
Z0021123	SB7180	K002965	SB7461RC
Z0021124	SB7190	K002964	SB7451RC
Z0021141	SB7181	K002963	SB7460RC
Z0021141AT		K002963	SB7460RC
Z0021141SAT		K002963	SB7460RC
Z0021141SC		K002963	SB7460RC
Z0021142	SB7191	K002962	SB7450RC
Z0021142AT		K002962	SB7450RC
Z0021142SAT		K002962	SB7450RC
Z0021142SC		K002962	SB7450RC
Z0021161	SB7623	K003796	SN7199RC
Z0021162	SB7633	K003795	SN7189RC
Z0021181	SB7182	K002967	SB7462RC
Z0021181AT		K002967	SB7462RC
Z0021182	SB7192	K002966	SB7452RC
Z0021182AT		K002966	SB7452RC
Z0021221	SB7184	K002963	SB7460RC
Z0021222	SB7194	K002962	SB7450RC
Z0021241	SB7169	K002965	SB7461RC
Z0021241AT		K002965	SB7461RC
Z0021242	SB7179	K002964	SB7451RC
Z0021242AT		K002964	SB7451RC
Z0021243	SB7169	K002965	SB7461RC

Dis Brake / Caliper Part No.	Dis Brake / Caliper Type No.	Rationalised Caliper Part No.	Rationalised Caliper Type No.
Z0021244	SB7179	K002964	SB7451RC
Z0021261	SB7500	K003810	SN7216RC
Z0021261AT		K003810	SN7216RC
Z0021262	SB7510	K003809	SN7206RC
Z0021262AT		K003809	SN7206RC
Z0021281	SB7508	K002786	SB7419RC
Z0021281AT		K002786	SB7419RC
Z0021282	SB7518	K002785	SB7409RC
Z0021282AT		K002785	SB7409RC
Z0021301	SB7509	K002965	SB7461RC
Z0021302	SB7519	K002964	SB7451RC

	Legend	Legende	Légende	Legenda
D	Outside Diameter	Aussendurchmesser	Diametre extérieur	Diametro esterno
E	Overall width	Gesamtbreite	Largeur totale	Larghezza totale
F	Mounting hole circle diameter	Befestigungsbohrungen, Teilkreisdurchmesser	Diametre trous de fixation	Diametro fori di fissaggio
G	Inside diameter	Innendurchmesser	Diametre intérieur	Diametro interno
H(min)	Thickness minimum	Dicke, min	épaisseur minimum	Spessore minimo
H(new)	Thickness new	Dicke, neu	Nouvelle épaisseur	Spessore nominale
J	Cooling channel width	Breite der Kühlkanäle	Largeur canal de refroidissement	Larghezza canale di raffreddamento
M	Number of mounting holes	Anzahl Befestigungsbohrungen	Nombre de trous de fixation	Numero dei fori di montaggio
	Hole diameter or thread	Durchmesser oder Gewindegröße	Diamètre de l'orifice ou taraudage	Diametro del foro o filettatura
X	With studs	Mit Stehbolzen	Avec goujons	Con colonnette

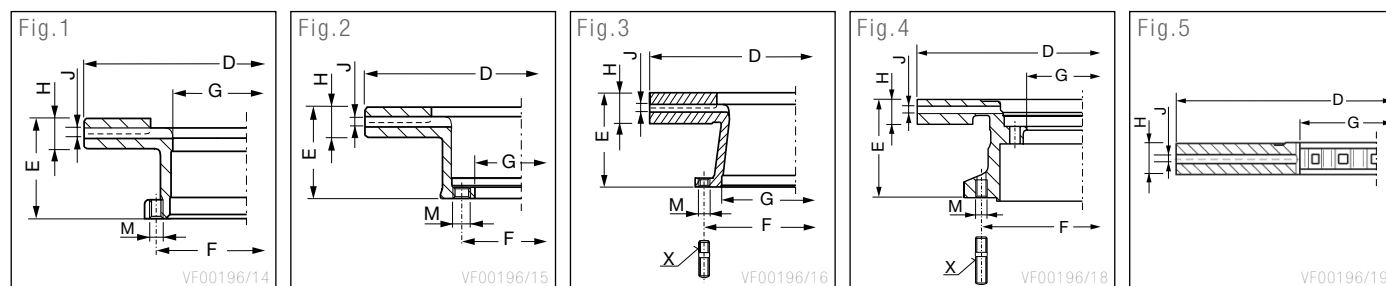

Part Number	Type Number	Fig.	D [mm]	E [mm]	F [mm]	G [mm]	H(new) [mm]	H(min) [mm]	J [mm]	M	X
II16404EVO	-	4	430	136,0	220	190	45,0	37,0	17	10 x M16x1,5	-
II30419	-	4	335	111,0	177	142	34,0	28,0	14	8 x M12x1,5	-
II37191	-	4	430	131	235	198	45	37	12	10 x M16x1,5	-
II371910061	-	4	430	131,0	235	203	45,0	37,0	12	10 x M16x1,5	-
II37415	-	4	430	136,0	220	194	45,0	37,0	12	10 x M16x1,5	-
II376380061	-	4	430	132,5	238	197	45,0	37,0	12	10 x M14x1,5	-
II376530061	-	4	430	131,0	235	200	45,0	38,0	12	10 x M16x1,5	-
II37654	-	4	436	138,5	240	210	45,0	37,0	12	12 x M16x2,0	X
II37783	-	2	430	140,5	168	196	45	37	12	12 x Ø19/3 x M12x1,5	-
II37784	-	2	432	130,0	168	131	45,0	37,0	12	12 x Ø19/3 x M12x1,5	-
II379830061	-	1	430	159,5	335	290	45,0	37,0	12	10 x Ø23	-
II37986	-	4	430	179,7	250	163	45,0	37,0	12	10 x 5/8"-18	-
II37988	-	1	432	135	270	186	45	37	12	10 x M16x1,5	-
II38335F	-	1	430	132,5	238	203	45,0	37,0	12	10 x M14x1,5	-
II38628F	-	4	377	138,5	196	163	45,0	37,0	12	8 x M14x1,5	-
II39023F	-	3	304	128,5	205	120	30,0	27,75	14	6 x Ø18,2	-
II39092F	-	4	290	105,0	170	68	22,0	19,0	-	6 x M18x1,5	X
II39093F	-	2	289	73,5	108	84	22,0	19,0	-	8 x Ø10,55	-
II39096F	-	3	322	134,0	275	136	30,0	27,75	14	8 x Ø20,2	-
II39098F	-	1	430	102,0	195	170	50,0	46,0	12	12 x M16x2,0	-

Part Number	Type Number	Fig.	D [mm]	E [mm]	F [mm]	G [mm]	H(new) [mm]	H(min) [mm]	J [mm]	M	X
II39278F	-	1	430	131	235	169	45	37	12	10 x M16x1,5	-
II39280F	-	2	377	112,0	144	117	45,0	37,0	12	10 x Ø14,75	-
II39284F	-	1	267	105,0	170	58	14,2	12,8	-	6 x M18x1,5	X
II39289F	-	1	438	135,0	235	186	45,0	35,0	12	10 x M16x1,5	-
II39290F	-	1	377	128,0	195	160	45,0	38,0		10 x M14x1,5	-
K000810	-	1	430	131,0	337	208	45,0	37,0	12	10 x M16x1,5	-
K005072	-	4	335	138	275	144,5	34	28	14	8 x Ø22.5/2 x M10x1,5	-
K005594	-	2	335	102,5	120	91	34,0	28,0		10 x Ø14,5	-
K005938	-	2	430	130,0	168	131	45,0	37,0	12	12 x Ø19/3 x M12x1,5	-
K012536	-	1	430	151	249,5	206	45	37	12	10 x M16x1,5	-
K013569	-	2	430	104	165	195	45	37	12	14 x Ø14,75	-
K013575	-	2	374	130,4	144	106	45	37	12	10 x Ø14,5	-
Z000557	-	2	430	104,7	165	135	45,0	37,0	12	14 x Ø14,75	-
Z0009911	-	5	432	-	-		45	37	12	-	-
Z001637	-	2	437	96,5	165	131	45,0	41,0		10 x Ø17,0	-
Z002016	-	2	377	134,0	138	105	45,0	37,0	12	14 x Ø14,4	-
Z002017	-	1	377	138,5	196	166	45,0	37,0	12	8 x Ø14,5	-
Z006407	-	2	430	114,7	165	135	45,0	37,0	12	14 x Ø14,75	-

Legend	Legende	Légende	Legenda
A	Port size	Anschlussgewinde	Raccord
A ₁	Flange	Flansch	Flangia
B	Voltage	Spannung	Tension
C	Normally Open (N/O), Normally Closed (N/C)	Stromlos, pneumatisch offen (N/O); Stromlos, pneumatisch geschlossen (N/C)	Normalment ouvert (N/O), Normalment fermé (N/C)
C ₁	At each electrical pulse, the current delivery port is exhausted and the alternate delivery port is opened	Bei jedem elektr. Impuls alternierende Schaltstellung	À chaque impulsion électrique, l'orifice de sortie est ouverte
D	Type	Typ	Tipo



Part Number	Type Number	Fig.	A	B [M]	C	D
0481500007000	–	1	M12x1,5	24	C ₁	4/2
0481500101000	–	2	M12x1,5	24	C ₁	4/2
0481500102000	–	2	M12x1,5	24	C ₁	4/2
0481500103000	–	2	M12x1,5	24	C ₁	4/2
0481500105000	–	2	M12x1,5	24	C ₁	4/2
0481503011000	–	3	M12x1,5	24	N/C	3/2

Part Number	Type Number	Fig.	A	B [V]	C	D
0481503018000	–	4	M12x1,5	24	N/C	3/2
0481511001000	–	5	M16x1,5	24	N/C	4/2
0481511002000	–	6	M16x1,5	24	N/C	4/2
0481511102100	–	7	M12x1,5	24	N/C	3/2
048151110513V	–	8	M16x1,5	24	N/C	3/2
0481511106100	–	8	M16x1,5	24	N/C	3/2
0486206101100	–	9	1/4"NPT	12	N/C	3/2
04862061022E4	–	9	1/4"NPT	24	N/C	3/2
0486206103100	–	9	M12x1,5	24	N/C	3/2
0486206104000	–	7	M12x1,5	24	N/C	3/2
1111661000	–		M12x1,5	24	N/C	3/2
EDP25AA	–	10	M12x1,5	24	N/C	3/2
EDP25AA/1	–	10	M12x1,5	24	N/C	3/2
EDP26AA	–	11	M12x1,5	24	N/O	3/2
EDP26AA/1	–	11	M12x1,5	24	N/O	3/2
EDP26AAX	–	11	M12x1,5	24	N/O	3/2
K015713N00	–	2	M12x1,5	24	C ₁	4/2
STK6736024	–	12	A ₁	24	N/O-N/C	5/2
II32611	EA1152	13	M12x1,5	24	N/C	3/2
K011708	EDP30A	14	M12x1,5	24	N/C	3/2

Legend	Legende	Légende	Legenda
A	Connection	Anschluss	Connettore
A ₁	Snap-on	Schnappanschluss	A innesto
A ₂	Hose connection Ø8 mm	Schlauchstutzen Ø8 mm	Connettore per tubo flessibile Ø8 mm
A ₃	Hose connection Ø14 mm	Schlauchstutzen Ø14 mm	Connettore per tubo flessibile Ø14 mm
B	For use on Air Dryers	Zur Verwendung am Lufttrockner	Per utilizzo su Essiccatori
C	Without diaphragm	Ohne membrane	Senza membrana
D	With 'O' ring	Mit O-Ring	Con 'O' ring



Part Number	Type Number	Fig.	A	Legend
0484210001000	–	1	M16x1,5	
0484210002000	–	1	M16x1,5	
0484210004000	–	2	A ₃	
0484210005000	–	3	A ₁	
0484210008000	–	4	A ₁	
0484210009000	–	5	A ₁	
0484210010000	–	2	A ₂	
0484210015000	–	6	A ₁	
0484210016000	–	4	A ₁	
0484210017000	–	7	A ₁	B

Part Number	Type Number	Fig.	A	Legend
0484210018000	–	1	M22x1,5	
1188230	–	8	3/8" BSP	
KW4069/1	–	9	1/2" BSP	
SIL68A	–	10	A ₁	
SIL68ASP	–	10	A ₁	
SIL68B	–	11	M22x1,5	
SIL68BK	–	11	M22x1,5	C
I78074	ZB3150	11	M22x1,5	
I92999	ZB3163	10	A ₁	B, D
I929991	ZB3163	10	A ₁	
II41063F	ZB3169	12	A ₁	B

	Page
39.1 Pressure Switches	190
39.2 Stop Lamp Switches	191
	Seite
39.1 Druckschalter, pneumatisch	190
39.2 Bremslichtschalter	191
	Page
39.1 Capteurs de Pression	190
39.2 Contact d'Allumage Stop	191
	Pagina
39.1 Interruttori Pneumatici	190
39.2 Interruttori Luci Stop	191

	Legend	Legende	Légende	Legenda
A	Pneumatic connection	Pneumatischer Anschluss	Raccord pneumatique	Connessione pneumatica
A ₁	External thread	Aussengewinde	Filetage extérieur	Filettatura esterna
A ₂	Internal thread	Innengewinde	Filetage interne	Filettatura interna
B	Electrical connection	Elektrischen Anschlüsse	Connexion électrique	Connettore elettrico
B ₁	M4x0,7 / Double Lucar	M4x0,7 / Zweipolig Lucar	M4x0,7 / Bipolaire	M4x0,7 / Bipolare
B ₂	Single Lucar	Einpolig Lucar	Unipolaire	Unipolare
B ₃	Double Lucar	Zweipolig Lucar	Bipolaire	Bipolare
B ₄	Double Lucar with M28x1,5	Zweipolig Lucar mit M28x1,5	Bipolaire avec M28x1,5	Bipolare con M28x1,5
B ₅	Single pin (Ø12 mm)	Einzelkontaktstift (Ø12 mm)	Une fiche (Ø12 mm)	Pin singolo (Ø12 mm)
B ₆	Double pin (Ø4 mm)	Doppelkontaktstift (Ø4 mm)	Deux fiches (Ø4 mm)	Pin doppio (Ø4 mm)
C	Voltage	Spannung	Tension	Tensione
D	Switching pressure (falling)	Schaltdruck (Druckabfall)	Indication de pression (descendante)	Pressione di contatto (caduta di tensione)
E	Switching pressure (rising)	Schaltdruck (Druckanstieg)	Indication de pression (montante)	Pressione di contatto (incremento)



Part Number	Type Number	Fig.	A ₁	A ₂	B	C Max [V]	D [bar]	E [bar]
267037	–	1	M12x1,5		B ₁	24	5,0	
272295	–	1	M12x1,5		B ₁	24	5,5	
295473	–	1	1/4" NPTF		B ₁	24	4,1	
295475	–	1	1/4" NPTF		B ₁	24	6,0	
295476	–	1	1/4" NPTF		B ₁	24	5,4	
IB8D	–		M20x1,5		B ₅	30	5,0	
IB9CY	–		M20x1,5		B ₂	30	6,4	
IB20BA	–		M20x1,5		B ₄	30	5,5	
IB20CA	–		M20x1,5		B ₄	30	6,4	
IB20DA	–		M20x1,5		B ₄	30	5,0	
IB20EA	–		M20x1,5		B ₄	30	5,8	
INT46E	–		M20x1,5		B ₄	30		5,8
I94846	WE2135	3		M12x1,5	B ₆	24	5,0	
II14936	WE2137	4	M12x1,5		B ₃	24	6,0	
I92570	WE2207	5		M12x1,5	B ₃	30	5,0	

Stop Lamp Switches Bremslichtschalter

Contact d'Allumage Stop Interruttori Luci Stop

	Legend	Legende	Légende	Legenda
A	Pneumatic connection	Pneumatischer Anschluss	Raccord pneumatique	Raccordi pneumatico
A ₁	External thread	Aussengewinde	Filetage extérieur	Filetto esterno
A ₂	Internal thread	Innengewinde	Filetage interne	Filettatura interna
B	Electrical connection	Elektrischen Anschlüsse	Connexion électrique	Connettore elettrico
B ₁	5/32" BSW / Double Lucar	5/32" BSW / Zweipolig Lucar	5/32" BSW / Bipolaire	5/32" BSW / Bipolare
B ₂	8-32 UNC	8-32 UNC	8-32 UNC	8-32 UNC
B ₃	Double Lucar	Zweipolig Lucar	Bipolaire	Bipolare
C	Switching pressure (rising)	Schaltdruck (Druckanstieg)	Indication de pression (montante)	Pressione di contatto (incremento)



Part Number	Type Number	Fig.	A ₁	A ₂	B	C [bar]
274746	–	1	1/4 NPTF		B ₁	0,35
287416	–	2	1/4 NPTF		B ₂	0,28
I71206	WE2131	3		M12x1,5	B ₃	0,30

	Legend	Legende	Légende	Legenda
A	Port size	Anschlussgewinde	Raccord	Raccordi
B	Pressure	Öffnungsdruck	Pression	Pressione



Part Number	Type Number	Fig.	A	B [bar]
109914	–	1	1/2" NPT	17,2
285849	–	1	1/4" NPTF	12,1
1113336000	–		M16x1,5	12,5
KX1729/1	–	2	M16x1,5	9,3
KX1729/2	–	2	M16x1,5	10,3
KX1729/3	–	2	M16x1,5	11,0
KX1729/4	–	2	M16x1,5	14,0
KX1729/5	–	2	M16x1,5	13,0
KX175/1	–	2	1/4" NPTF	11,0
KX175/4	–	2	1/4" NPTF	9,0
KX2073/7	–	3	1/4" NPTF	11,0
KX2073/13	–	3	1/4" NPTF	14,0
K000701	AE7110	4	M10x1,0	4,0
I84406	DR5117	5	M26x1,5	13,0
I84414	DR5118	5	M26x1,5	15,0
I94158	DR5122	5	M26x1,5	9,0
I99812	DR5125	5	M26x1,5	17,0
K040676N00	DR5128		M16x1,5	19,0
I67981	SIV-10K		M22x1,5	1,3

	Page
41.1 Levelling Valves	194
41.2 Adjusting Elements	199
	Seite
41.1 Luftfederungsventile	194
41.2 Stellelemente (Niveauverstellung)	199
	Page
41.1 Valves de Nivellement	194
41.2 Valves d'Arrêt-Réglable	199
	Pagina
41.1 Valvole Livellatrici	194
41.2 Valvole Limitatrici di Corsa – Leva Regolabile	199

Legend	Legende	Légende	Legenda
A1	Supply	Eingang	Alimentazione
A2	Delivery	Ausgang	Uscita
A4	Control	Steuerung	Comando
B	Datum adjustment	Nullpunktverstellung	Spostamento del punto neutro
C	Height limitation	Höhenbegrenzung	Limitazione di corsa
C ₁	Adjustable: 20° to 50°	Einstellbar: 20° – 50°	Regolabile: da 20° a 50°
D	Lever length	Hebellänge	Lunghezza dell'asta
E	Cross throttling feature	Querdrosselung	Strozzamento
E ₁	Cross block	Quersperre	Blocco trasversale
E ₂	With cross throttling	Mit Querdrosselung	Con strozzamento
E ₃	Without cross throttling	Ohne Querdrosselung	Senza strozzamento
F	Lever	Hebel	Leva
F ₁	Round lever	Hebelausführung rund	Posizionamento con leva tonda
F ₂	Flat lever	Hebelausführung flach	Posizionamento con leva piatta
F ₃	Flat or round lever	Hebelausführung flach oder rund	Posizionamento con leva piatta o tonda
F ₄	With ball stud	Mit Kugelbolzen	Con vite sferica
H	Mounting	Einbaulage	Montaggio
H ₁	Right	Rechts	Destra
H ₂	Left	Links	Sinistra
H ₃	Horizontal	Horizontal	Orizzontale
J	Secondary exhaust	Sekundärentlüftung	Scarico supplementare
J ₁	Without secondary exhaust	Ohne Sekundärentlüftung	Senza scarico supplementare
J ₂	With secondary exhaust	Mit Sekundärentlüftung	Con scarico supplementare
K	Flow characteristic	Durchflusskennlinie	Caratteristica di portata
N _n	Normal	Normal	Caratteristica normale
G _n	Throttled	Gedrosselt	Caratteristica con strozzatura
Q _n	Cross throttled	Quer, gedrosselt	Caratteristica con strozzatura incrociata
S _n	Special	Sonderkennlinie	Caratteristica speciale
¹⁾	Push-in	Steckanschluss	A innesto

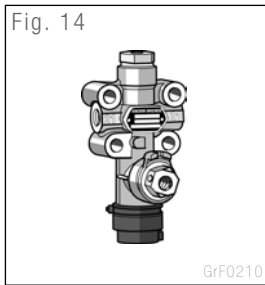
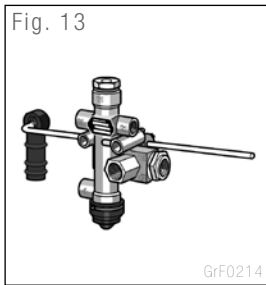
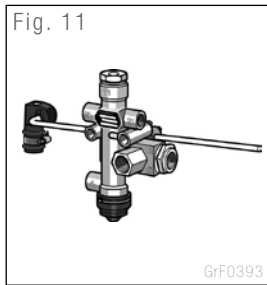
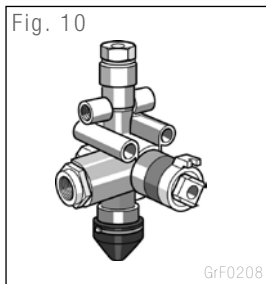
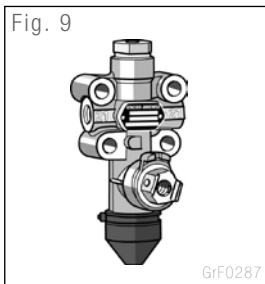
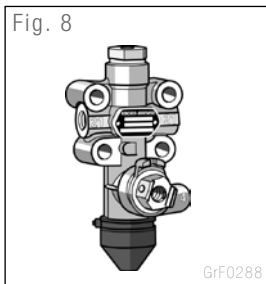
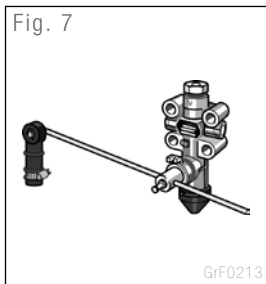
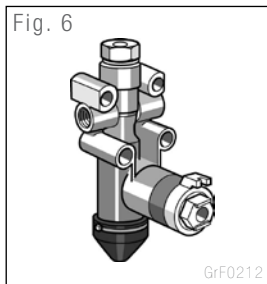
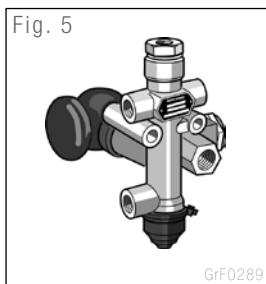
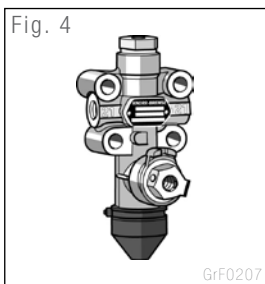

41 (41.1)

Levelling Valves
Luftfederungsventile

Valves de Nivellement
Valvole Livellatrici

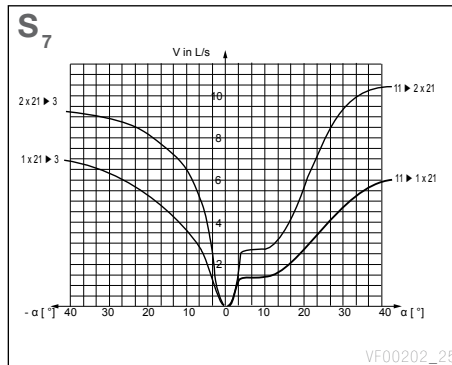
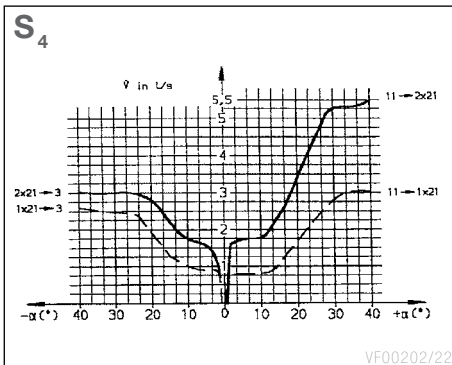
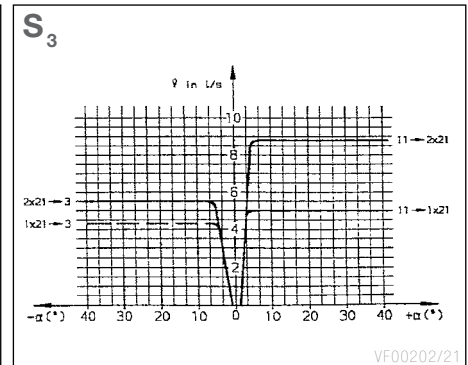
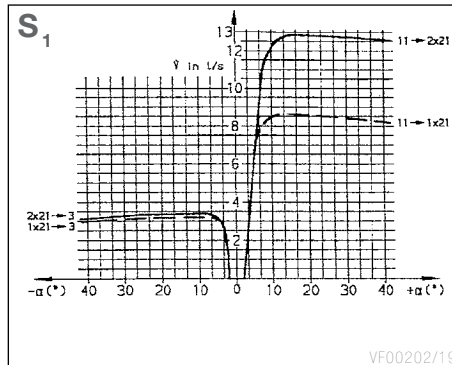
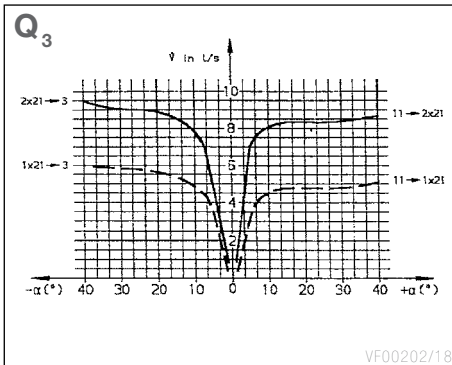
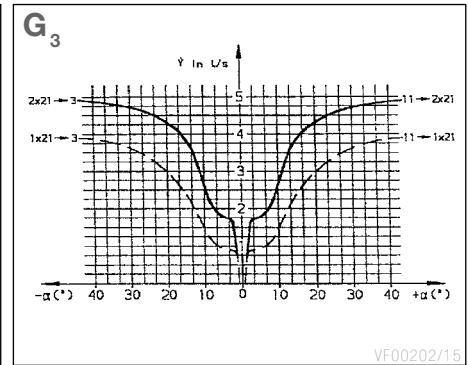
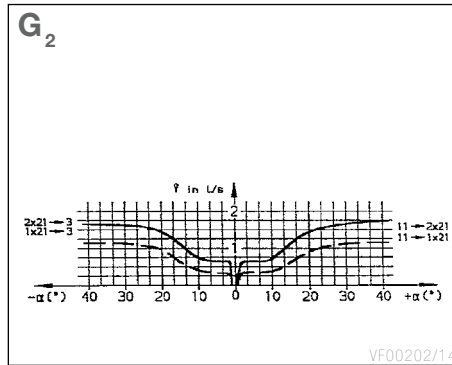
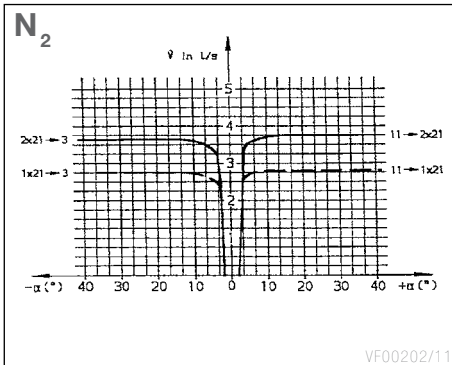

Part Number	Type Number	Fig.	A		B [°]	C [°]	D [mm]	E	F	H	J	K
			1 & 2	4								
0500004201000	–	1	Ø6 mm ¹⁾				200		F ₁			
050000420419Z	–	1	M10x1	–	–	–	200	E ₃	F ₄	H ₃		
0500005001000	–	2	M12x1,5				175	E ₂	F ₄			
0500005002000	–	2	M12x1,5				175	E ₂	F ₄			
0500005006000	–	3	M12x1,5				90	E ₂	F ₂			
0500005007000	–	3	M12x1,5				90	E ₂	F ₂			
0500005011000	–	3	M12x1,5				90	E ₂	F ₂			
0500005012000	–	3	M12x1,5				90	E ₂	F ₂			
0500005017000	–	2	M12x1,5				250	E ₂	F ₂	H ₁		
0500005101000	–	2	M12x1,5				175	E ₁	F ₄			
0500005104000	–	3	M12x1,5				90	E ₁	F ₂			
0500005105000	–	3	M12x1,5				90	E ₁	F ₂			
K003089	–	2	M12x1,5	–	–	–	175	E ₃	F ₂	H ₃		
K003090	–	2	M12x1,5	–	–	–	175	E ₃	F ₂	H ₃		
K003096	–	2	M12x1,5	–	–	–	175	E ₂	F ₂	H ₁ , H ₃		
K005589	–	2	M12x1,5	–	–	–	160	E ₃	F ₂	H ₁		
K005590	–	2	M12x1,5	–	–	–	160	E ₃	F ₂	H ₂		
K005591	–	2	M12x1,5	–	–	–	70	E ₂	F ₂	H ₁		
K005592	–	2	M12x1,5	–	–	–	120	E ₂	F ₂	H ₁		
K005934	–	2	M12x1,5	–	–	–	160	E ₃	F ₂	H ₁		
K005935	–	2	M12x1,5	–	–	–	160	E ₃	F ₂	H ₂		
I80091	SV1294	4	M12x1,5	M12x1,5	–	–	–	E ₃	F ₂		J ₁	N ₂
K002335	SV1294	4	M12x1,5	M12x1,5	–	–	–	E ₃	F ₂		J ₁	N ₂
II32763	SV1303	5	M12&M16x1,5	M12x1,5	17,5	39,5			F ₂		J ₂	S ₃
I85919	SV1304	6	M12x1,5	–	–	–	–		F ₂			S ₁
K024765N00	SV1307	7	M12x1,5		–	–	290		F ₂			G ₂
II36108	SV1318	8	M12x1,5	M12x1,5	26,0		160		F ₂			N ₂
II32764	SV1323	8	M12&M16x1,5	M12x1,5	19,5		–	E ₃	F ₂		J ₁	G ₂
II32765	SV1328	8	M12&M16x1,5						F ₂			G ₂
K002334	SV1351	8	M12x1,5	M12x1,5	19,5				F ₂			N ₂
II30525000	SV1399	8	M12x1,5	M12x1,5	26,0			E ₃	F ₂		J ₁	S ₄
I98290	SV1411	9	M12x1,5	–	–	–		E ₃	F ₁		J ₁	N ₂
K000073	SV1412	9	M12x1,5					E ₃	F ₂		J ₁	S ₄
II16189	SV1425	10	M12&M16x1,5			42,0	195		F ₂	H ₁	J ₂	G ₃
II34910	SV1447	11	M12&M16x1,5	M12x1,5	17,5		300	E ₂	F ₁	H ₂		Q ₃
K024764N00	SV1460	12	M12x1,5		–	–	290	E ₃	F ₃			S ₇
II36115	SV1466	13	M12&M16x1,5			C ₁	290		F ₁		J ₂	S ₇
II36117	SV1467	7	1/4" NPTF			–	290	E ₂	F ₁			G ₂
II36118	SV1468	14	1/4" NPTF			–	290	E ₂	F ₁	H ₃		G ₂
K000069	SV1468	14	1/4" NPTF	–	–	–	–				J ₁	G ₂

41 (41.1)

Levelling Valves
Luftfederungsventile

Valves de Nivellement
Valvole Livellatrici

Part Number	Type Number	Fig.	A		B [°]	C [°]	D [mm]	E	F	H	J	K
			1 & 2	4								
II36121	SV1470	12	M12x1,5		–	–	290	E ₃	F ₁		J ₁	G ₃
II36169	SV1481	12	M12x1,5	–	–	–	160	E ₃	F ₂		J ₁	N ₂
II36171	SV1482	12	M12x1,5	–	–	–	200	E ₃	F ₂		J ₁	N ₂
II36212	SV1483	7	1/4" NPTF	–	–	–	290	E ₂	F ₁			G ₃
K000367	SV1485	15	M12&M16x1,5	–	10,0	25,0	290	E ₃	F ₁			S ₇
K000264	SV1490	16	Ø6 mm ¹⁾	–	–	–	161	E ₃	F ₂	H ₂		
K000661	SV1491	16	Ø6 mm ¹⁾	–	–	–	161	E ₃	F ₂	H ₁		
K001245	SV1493	16	Ø6 mm ¹⁾	–	–	–	161	E ₃	F ₂	H ₁		
K002336	SV1494	14	M12x1,5	–	–	–	–	E ₃				N ₂
K002398	SV1496	16	Ø6 mm ¹⁾	–	–	–	161	E ₃	F ₂	H ₁		

Adjusting Elements
Stellelemente (Niveauverstellung)

Valves d'Arrêt-Réglable
Valvole Limitatrici di Corsa – Leva Regolabile

Legend	Legende	Légende	Legenda
A Port size	Anschlussgewinde	Raccord	Raccordi
P Control pressure	Steuerdruck	Pression de contrôle	Pressione di comando



Part Number	Type Number	Fig.	A	P [bar]
0504003001000	-	1	M10x1,0	5,5 – 12,5

Legend	Legende	Légende	Legenda
A1	Supply	Eingang	Alimentation
A2	Delivery	Ausgang	Sortie
A3	Exhaust	Entlüftung	Echappement
A ₄	With 'Wira' fitting	Mit 'Wira' Verschraubung	Avec Raccord "Wira"
B	Number of levers	Anzahl der Hebel	Nombre de Leviers
C	Number of valve elements	Anzahl der Schaltkreise	Nombre de circuit
E	Electrical connection bayonet	Elektrischer Anschluss Bajonett	Connecteur électrique à baïonnette
F	Test point	Prüfanschluss	Point test
SP	Spring return to 'STOP' feature	Automatischer Rücklauf auf STOP	Retour à la position 'STOP'



Part Number	Type Number	Fig.	A			B	C	Legend
			1	2	3			
II36075	SV3162	1	M16x1,5	M16x1,5		1	1	
II36151	SV3230	2	M22x1,5	M16x1,5		1	1	SP
K002018	SV3240	2	M22x1,5	M16x1,5		1	1	SP
K022847N00	SV3801	3	M22x1,5	M16x1,5		1	1	E, F, SP

	Page
43.1 ELC Compressors	203
43.2 ELC Air Dryers	203
43.3 ELC Valve Blocks	204
43.4 ELC ECUs	205
43.5 Level Sensors	205
	Seite
43.1 ELC-Kompressoren	203
43.2 ELC-Lufttrockner	203
43.3 ELC-Ventilblöcke	204
43.4 ELC-Elektronische Steuergeräte	205
43.5 ELC-Niveaugeber	205
	Page
43.1 Compresseurs ELC	203
43.2 Dessiccateurs ELC	203
43.3 Ensemble Valves ELC	204
43.4 ELC ECUs	205
43.5 Capteurs de Niveau	205
	Pagina
43.1 Compressori ELC	203
43.2 Essiccatori ELC	203
43.3 Moduli ELC	204
43.4 ECU ELC	205
43.5 Sensori di Livello	205

	Legend	Legende	Légende	Legenda
A1	Supply	Eingang	Alimentation	Alimentazione
A2	Delivery	Ausgang	Sortie	Uscita
A3	Exhaust	Entlüftung	Echappement	Scarico
A4	Control	Steuerung	Pilotage	Comando
B	Electrical connection	Elektrischer Anschluss	Connexion électriques	Connessione elettrica
B ₁	Plug connector 280 Metri-Pack	Stecker 280 Metri-Pack	Prise connexion 280Metri-Pack	Connettore a presa 280 Metri-Pack
B ₂	Bayonet, DIN 72585	Bajonett, DIN 72585	Baionette, DIN 72585	Baionetta, DIN 72585
B ₃	Bayonet, Schlemmer	Bajonett, Schlemmer	Baionette, Schlemmer	Baionetta, Schlemmer
B ₄	Connection, 35 pole blade terminal	Stecker 35 polig	Connexion, 35 Pole Blade Terminal	Connettore a pettine, 35 Poli
B ₅	Connection, 3pin 4mm dia, Bayonet 27,4mm dia.	3pin:Ø 4mm; Bajonett: Ø 27,4mm	Connexion, 3 pin dia. 4 mm, Baionnette dia. 27,4 mm	Connessione, 3 pin Ø 4mm, Baionetta Ø 27,4mm
C	Voltage	Spannung	Tension	Tensione
D	Maximum delivery pressure	Maximaler Ausgangsdruck	Pression d'autolimitation	Pressione massima d'uscita
E	Heater voltage	Heizungbetriebsspannung	Voltage de chauffage	Tensione del riscaldatore
F	Cross throttling	Querdrosselung	Etranglement	Strozzatura
G	Truck rear axle	Motorwagen Hinterachse	Essieu Arrière Camion	Asse posteriore motrice
H	Kneeling	Absenkung	Coudé	Ginocchio
H ₁	on front axle	an Vorderachse	sur l'essieu avant	sull'assale anteriore
H ₂	on rear axle	an Hinterachse	sur l'essieu arrière	sull'assale posteriore
J	Application	Anwendung	Application	Applicazione
K	Lever working range	Hebel Arbeitsbereich	Angle de travail	Angolo di lavoro
L	Permissable load	Zulässige Belastung	Charge admise	Carico consentito
1)	Silencer	Schalldämpfer	Silencieux	Silenzio

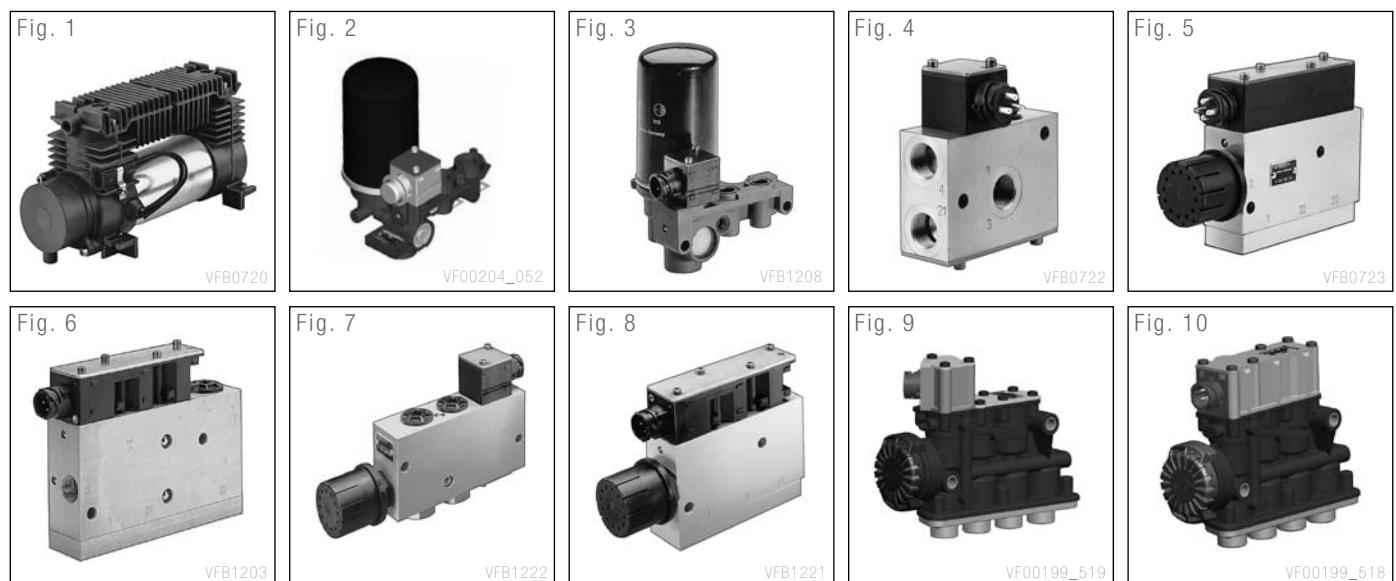

ELC – Electronic Level Control System
ELC – Elektronisches Niveauregelsystem

Système de Contrôle du Niveau par l'électronique (ELC)
Sistema di Controllo Livellamento Elettronico (ELC)



43.1

ELC Compressors
ELC-Kompressoren
Compresseurs ELC
Compressori ELC

Part Number	Type Number	Fig.	A	B	C	D
			2			
			[M]		[V]	[bar]
0504050001000	–	1	M12x1,5	B ₁	12	5,0
0504050007000	–	1	M12x1,5	B ₁	12	12,5
0504050008000	–	1	M12x1,5	B ₁	24	12,5
K001319N00	–	1	M12x1,5	B ₁	12	12,5

43.2

ELC Air Dryers
ELC-Lufttrockner
Dessiccateurs ELC
Essiccatori ELC

Part Number	Type Number	Fig.	A	B	E
			1 & 2		
			[M]		[V]
0501100401170	–	2	M12x1,5	B ₂	12
0501100402170	–	2	M12x1,5	B ₂	24
0501100407100	–	3	M12x1,5	B ₂	12

43 (43.1 – 43.5)

ELC – Electronic Level Control System
ELC – Elektronisches Niveauregelsystem

Système de Contrôle du Niveau par l'électronique (ELC)
Sistema di Controllo Livellamento Elettronico (ELC)

43.3

ELC Valve Blocks

ELC-Ventilblöcke

Ensemble Valves ELC

Moduli ELC

Part Number	Type Number	Fig.	A			B	C [V]	Legend
			1 & 2	3	4			
0501100009000	–	4	M22x1,5	–	M22x1,5	B ₃	24	
0501100011000	–	5	M22x1,5	M22x1,5	–	B ₃	24	
050110001613V	–	6	M16x1,5	M16x1,5	–	B ₂	24	F, H
050110001905T	–	–	M16x1,5	–	–	B ₂	24	F
0501100025000	–	5	M16x1,5	M22x1,5	–	B ₂	24	F, H
0501100027066	–	5	M16x1,5	M22x1,5	–	B ₂	24	
0501100028066	–	6	M16x1,5	M22x1,5	–	B ₂	24	F, H
0501100029000	–	8	M16x1,5	M16x1,5	–	B ₂	24	
0501100031000	–	8	M16x1,5	M16x1,5	–	B ₂	24	
050110003719Z	–	–	M16x1,5	–	M12x1,5	B ₂	24	
0501100038100	–	–	M16x1,5	–	M12x1,5	B ₂	24	
0501100040100	–	8	M16x1,5	M16x1,5	–	B ₂	24	G
0501100041100	–	6	M16x1,5	M16x1,5	–	B ₂	24	F, H
050110005005T	–	8	M16x1,5	M16x1,5	–	B ₂	24	
050110005105T	–	8	M16x1,5	M16x1,5	–	B ₂	24	
K019819N50	–	9	M16x1,5	¹⁾	–	B ₂	24	
K019820N50	–	10	M16x1,5	¹⁾	–	B ₂	24	
K019821N50	–	10	M16x1,5	¹⁾	–	B ₂	24	

ELC – Electronic Level Control System
 ELC – Elektronisches Niveauregelsystem

Système de Contrôle du Niveau par l'électronique (ELC)
 Sistema di Controllo Livellamento Elettronico (ELC)

43.4

ELC ECUs

Elektronische Steuergeräte

ELC ECUs

ECU ELC

Part Number	Type Number	Fig.	B	C [V]	H	J
0504004105000	–	11	B ₄	24		Volvo
0504004106100	–	11	B ₄	24		
0504004109000	–	11	B ₄	24		Scania
0504004114000	–	11	B ₄	24	H ₁	Irisbus
0504004115000	–	11	B ₄	24	H ₂	Irisbus

43.5

Level Sensors

ELC-Niveaugeber

Capteurs de Niveau

Sensori di Livello

Part Number	Type Number	Fig.	B	K [°]
0504002104000	–	12	B ₅	+/-40
0504002111066	–	12	B ₂	+/-40
0504002113100	–	12	B ₅	+/-40
0504002114000	–	12	B ₅	+/-32,5
K013741N00	–	13	B ₂	+/-60

	Legend	Legende	Légende	Legenda
A1	Supply	Eingang	Alimentation	Alimentazione
A2	Delivery	Ausgang	Sortie	Uscita
A4	Control	Steuerung	Pilotage	Comando
B	Voltage	Spannung	Tension	Tensione
R	Auto-raise	Automatisches Achsanheben	Montée automatique	Sollevamento Automatico
S	With solenoid	Mit Magnetventil	Avec électrovalve	Con elettrovalvola
¹⁾	Push-in	Steckanschluss	En appui	A innesto

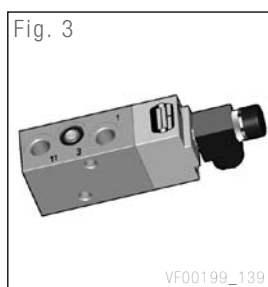
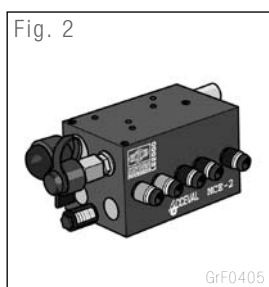

Part Number	Type Number	Fig.	A			B [V]	Legend
			1	2	4		
K022468N00	–	1	M12x1,5	M16x1,5	–	24	S
LS1500	–	2	Ø8 mm ¹⁾	Ø8 mm ¹⁾	Ø8 mm ¹⁾	–	
LS2000	–	2	Ø8 mm ¹⁾	Ø8 mm ¹⁾	Ø8 mm ¹⁾	–	R
K008546	AE1141	3	M16x1,5	M16x1,5	–	24	S
K015384N00	AE1141	4	Ø8 mm ¹⁾	Ø8 mm ¹⁾	–	24	S
K017224N00	AE1141	5	Ø8 mm ¹⁾	Ø8 mm ¹⁾	Ø8 mm ¹⁾	–	
K019882N00	AE1141	4	Ø8 mm ¹⁾	Ø8 mm ¹⁾	–	12	S
K035570N00	AE1141	3	M16x1,5	M16x1,5	M16x1,5	24	S

	Page
45.1 Clutch Servos	208
45.2 Clutch Servos (Kongsberg)	210
45.3 Electronic Clutch Actuators	212
45.4 Master Cylinders	213
45.5 Master Cylinders (Kongsberg)	214
45.6 Slave Cylinders	215
45.7 Clutch Actuating Modules	216
	Seite
45.1 Kupplungskraftverstärker	208
45.2 Kupplungskraftverstärker (Kongsberg)	210
45.3 Elektronischer Kupplungssteller	212
45.4 Geberzylinder	213
45.5 Geberzylinder (Kongsberg)	214
45.6 Nehmerzylinder	215
45.7 Kupplungsbetätigungsmodul	216
	Page
45.1 Servos Débrayage	208
45.2 Servos Débrayage (Kongsberg)	210
45.3 Servo embrayage électronique	212
45.4 Maîtres cylindres	213
45.5 Maîtres cylindres (Kongsberg)	214
45.6 Cylindre de travail	215
45.7 Module d'Actionnement d'Embrayage	216
	Pagina
45.1 Servofrizioni	208
45.2 Servofrizioni (Kongsberg)	210
45.3 Attuatori Frizione Elettronici	212
45.4 Cilindri Maestro	213
45.5 Cilindri Maestro (Kongsberg)	214
45.6 Cilindri Attuatori	215
45.7 Moduli Attuazione Frizione	216

Legend		Legende	Légende	Legenda
A1	Air supply	Pneumatischer Eingang	Alimentation d'air	Alimentazione pneumatica
H1	Hydraulic port	Hydraulischer Anschluss	Raccord hydraulique	Raccordo idraulica
B	Servo piston diameter	Servokolben-Ø	Ø du piston	Ø Stantuffo
B ₁	Diaphragm	Membrane	Membrane	Membrana
C	Piston area	Kolbenwirkfläche	Section du piston	Area pistone
D	Stroke	Hub	Course	Corsa
S	Stroke switch fitted	Mit Hubwarnschalter	Indicateur de fin de course	Con interruttore di fine corsa
M	Mechanical output	Mechanischer Kraftausgang	Sortie Mécanique	Uscita meccanica
O	With control port for SAMT	Mit Steueranschluss für SAMT	Avec orifice de pilotage pour SAMT	Per cambio tipo SAMT
P	Hydraulic output	Hydraulischer Ausgang	Sortie hydraulique	Uscita idraulica

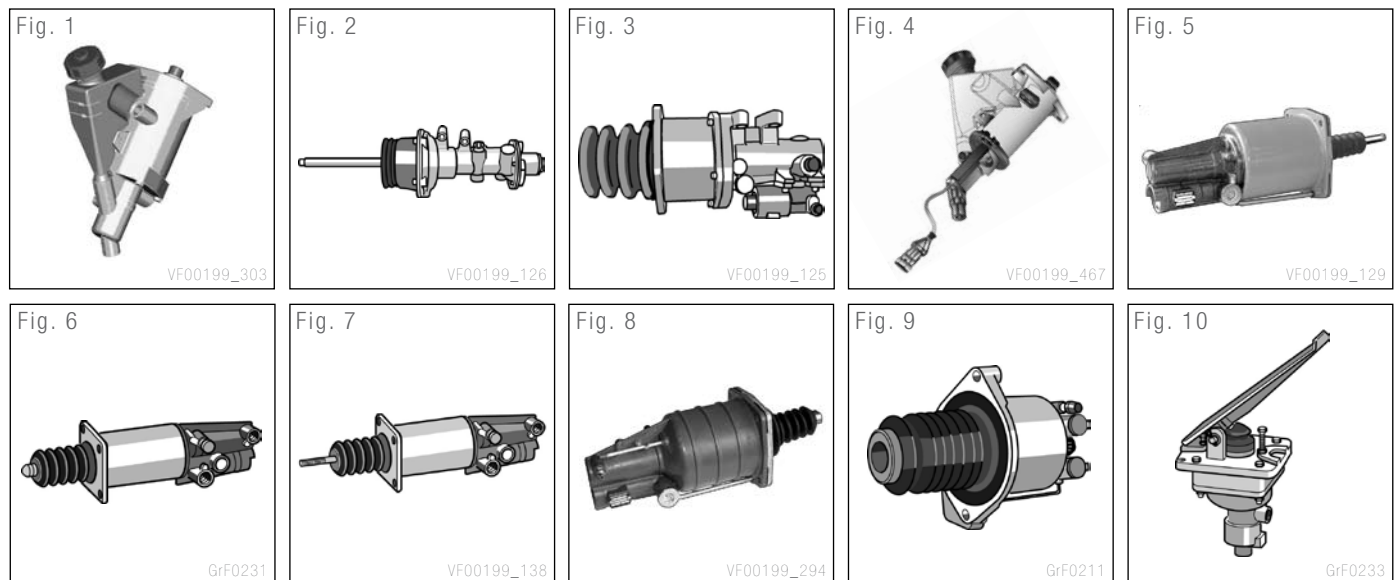

Part Number	Type Number	Fig.	A1	H1	B [mm]	C [cm ²]	D [mm]	S	M	O	P
SM1A	–	1	M12x1,5	M14x1,5	52		38				P
SM2A	–	1	M12x1,5	M14x1,5			38	S			P
1407023C	SF3	2	M14x1,5	M16x1,5	B1		40		M		
1409284C	SF17	2	M14x1,5	M16x1,5	105		52 Max.		M		
1409285C	SF18	2	M14x1,5	M16x1,5	105		52 Max.		M		
1422762C	SF42	3	M16x1,5	M14x1,5	100		72		M		
K044312S01	SM1LA	4	M12x1,5	M14x1,5		5,06	38 Max	S			P
K022028N00	SM1PLB	4	M12x1,5	M14x1,5		5,06	40 Max	S			P
K015237N00	SM1PLD	4	M12x1,5	M14x1,5		5,06	40 Max	S			P
K044874N00	SM2PA	4	M12x1,5	M14x1,5		8,03	38 Max	S			P
K044873N00	SM2PD	4	M12x1,5	M14x1,5		8,03	38 Max	S			P
I92489	VG3213	5	M16x1,5	M14x1,5	100		64		M		
II19612	VG3238	6	M16x1,5	M14x1,5	100		64		M		
II35696	VG3264	6	M16x1,5	M14x1,5	100		80		M		

Part Number	Type Number	Fig.	A1	H1	B [mm]	C [cm ²]	D [mm]	S	M	O	P
II36373	VG3265	7	M16x1,5	M14x1,5	75		84		M		
II36377	VG3267	7	M16x1,5	M14x1,5	75		84		M		
II37933	VG3268	6	M16x1,5	M14x1,5	100		84		M		
II36379	VG3269	6	M16x1,5	M14x1,5	102		78		M		
II40096F	VG3276	6	M22x1,5	M14x1,5	95		40		M		
II40381F	VG3282	6	M16x1,5	M14x1,5	70		40		M		
K000411	VG3283	5	M16x1,5	M14x1,5	100		64		M		
K000511	VG3284	5	M16x1,5	M14x1,5	100		84		M		
K001071	VG3285	6	M16x1,5	M14x1,5	70		40		M		
K002173	VG3286	8	M16x1,5	M14x1,5			78		M		
K004295	VG3287	8	M16x1,5	M14x1,5			78		M		
K004296	VG3288	6	M16x1,5	M14x1,5	100		78		M		
K004297	VG3289	6	M16x1,5	M14x1,5	100		78		M		
II17771	VG3364	9	M16x1,5	M14x1,5	102		70		M		
II37940	VG3365	9	M16x1,5	M14x1,5	102		70		M		
I87819	VG8125	10	M22x1,5	M12x1,0							P

Legend	Legende	Légende	Legenda	
A1	Air supply	Pneumatischer Eingang	Alimentation d'air	Alimentazione pneumatica
H2	Hydraulic delivery	Hydraulischer Ausgang	Sortie Hydraulique	Alimentazione idraulica
H4	Hydraulic control	Hydraulisch Steuerung	Pilotage Hydraulique	Comando idraulico
B	Servo piston diameter	Servokolben-Ø	Ø du piston	Stantuffo Ø
C	Stroke	Hub	Course	Corsa
M	Mechanical Output	Mechanischer Kraftausgang	Sortie Mécanique	Uscita meccanica

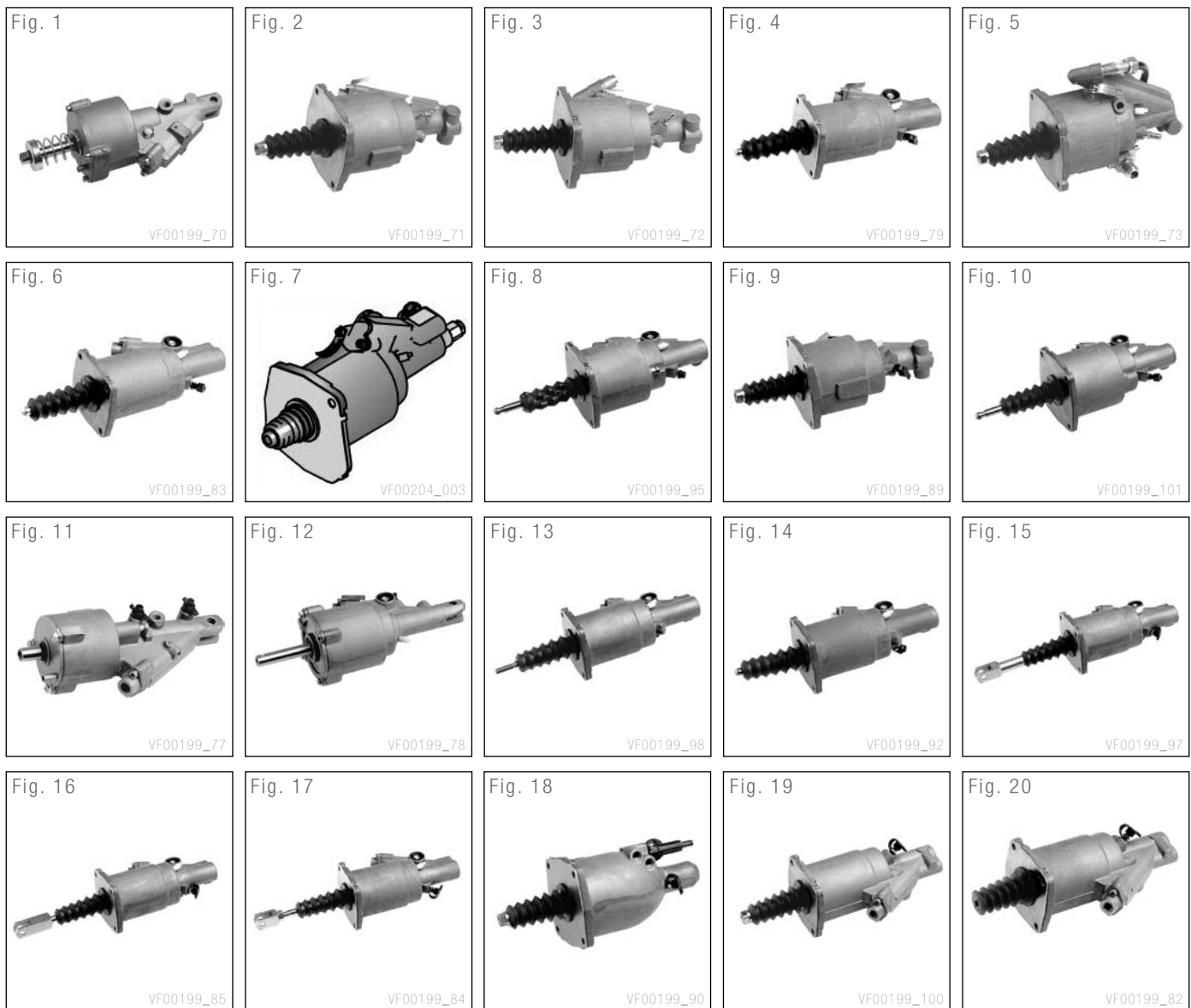

Clutch Servos (Kongsberg)
Kupplungskraftverstärker (Kongsberg)

Servos Débrayage (Kongsberg)
Servofrizioni (Kongsberg)

Part Number	Type Number	Fig.	A1	H2	H4	B [mm]	C [mm]	M
622107AM	–	1	M14x1,5	–	M12x1,5	100	53	M
622109AM	–		M14x1,5	–	M12x1,5	100	53	M
622190AM	–	2	M14x1,5	–	M14x1,5	100	70	M
622199AM	–	3	M22x1,5 Voss 232	–	M14x1,5	100	70	M
622502AM	–	4	M16x1,5	–	M14x1,5	80	85	M
624199AM	–	5	M14x1,5	–	M14x1,5	100	70	M
625290AM	–	6	M16x1,5	–	M14x1,5	80	85	M
625375AM	–	7	M16x1,5	–	Ø12	100	85	M
625524AM	–	9	M16x1,5	–	M14x1,5	100	70	M
625586AM	–	10	M16x1,5	–	M14x1,5	100	85	M
625862AM	–		M16x1,5	–	M14x1,5	100	85	M
626162AM	–	9	M16x1,5	–	M14x1,5	100	70	M
626392AM	–	11	M16x1,5	–	7/16 UNF	80	52	M
626639AM	–	12	M16x1,5	–	M14x1,5	95	72	M
626693AM	–	13	M16x1,5	–	M14x1,5	80	85	M
626853AM	–	14	M16x1,5	–	M14x1,5	80	85	M
627497AM	–	15	M16x1,5	–	M14x1,5	80	85	M
627498AM	–	16	M16x1,5	–	M14x1,5	80	85	M
627499AM	–	17	M16x1,5	–	M14x1,5	80	85	M
627612AM	–	18	M16x1,5	–	M14x1,5	100	70	M
628027AM	–		M22x1,5 Voss 232	–	M14x1,5	100	83	M
628036AM	–		M16x1,5	–	M14x1,5	100	85	M
628258AM	–		M16x1,5	–	M14x1,5	100	85	M
628259AM	–		M16x1,5	–	M14x1,5	100	85	M
628260AM	–		M16x1,5	–	M14x1,5	100	85	M
628275AM	–	6	M16x1,5	–	M14x1,5	100	85	M
628276AM	–	6	M16x1,5	–	M14x1,5	80	85	M
628277AM	–		M16x1,5	–	M14x1,5	80	85	M
628448AM	–		M16x1,5	–	M14x1,5	100	85	M
628450AM	–		M16x1,5	–	M14x1,5	100	85	M
628494AM	–		M16x1,5	–	M14x1,5	100	85	M
629276AM	–		M16x1,5	–	M14x1,5	100	85	M
629277AM	–	19	M16x1,5	–	M14x1,5	100	85	M
629300AM	–		M16x1,5	–	M14x1,5	100	70	M
629479AM	–	20	M16x1,5	–	M14x1,5	80	85	M
629683AM	–		Raufoss 7236	M14x1,5	–	100	26	–
630361AM	–		M22x1,5 Voss 232	–	M14x1,5	100	85	M

	Legend	Legende	Légende	Legenda
A	Air Supply port(s) size	Dimension Anschlüsse 1 (Vorrat)	Dimension Orifice(s) d'alimentation	Dimensione raccordo di alimentazione "1"
B	Connector	Anschlüsse	Connections	Connettore
B ₁	G+H	G+H	G+H	G+H
B ₂	Socket connector Kostal 09 4320 01	Buchse Kostal 09 4320 01	Prise Kostal 09 4320 01	Connettore di riduzione Kostal 09 4320 01
B ₃	AMP 1-967325-1	AMP 1-967325-1	AMP 1-967325-1	AMP 1-967325-1
C	Integrated silencer	Integrierter Schalldämpfer	Avec silencieux intégré	Con silenziatore integrato
D	Pneumatic servo mechanical output	Pneumatikverstärker mechanisch wirkend	Servo débrayage sortie mécanique	Comando pneumatico, uscita meccanica
E	Servo Piston diameter	Durchmesser Servokolben	Ø du piston	Diametro del pistone
F	Stroke	Hub	Course	Corsa
G	Supply pressure	Betriebsdruck – Eingang	Pression d'alimentation	Pressione alimentazione
H	Nominal operating pressure	Arbeitsdruck	Pression de service	Pressione nominale di esercizio
I	Voltage solenoids	Spannung Magnete	Tension	Tensione dei solenoidi
J	Voltage sensor	Spannung Sensor	Tension capteur	Tensione del sensore
K	Piston force	Kolbenkraft	Effort piston	Forza del pistone
L	Piston force at 6 bar	Kolbenkraft bei Arbeitsdruck 6 bar	Effort Piston 6 bar	Forza del pistone a 6 bar



Part Number	Type Number	Fig.	A	B	C	D	E	F	G	H	I	J	K	L
							[mm]	[mm]	Max [bar]	[bar]	Min/max [V]	[V]	Max [kN]	[kN]
048300500405T	–	1	M16x1,5	B ₁	C	D	100	70	12	6	19,5/29	5	8	4
0483005008100	–	2	M16x1,5	B ₂ ,B ₃	C	D	100	70	12	6	19,5/29	5	8	4
0483005011100	–	2	M16x1,5	B ₂ ,B ₃	C	D	100	70	12	6	19,5/29	5	8	4
K013727	–	2	M16x1,5	B ₂ ,B ₃	C	D	100	70	12	6,5	19,7/29	5	8	4
K015875N50 ¹⁾	–	3	M16x1,5	B ₂	C	D	100	70	12	6	19,5/29	5	8	4
K019858	–	2	M16x1,5	B ₂ ,B ₃	C	D	100	70	12	6,5	19,7/29	5	8	4
K024074	–	2	M16x1,5	B ₂ ,B ₃	C	D	100	70	12	6,5	19,7/29	5	8	4

- 1) This product must be calibrated after replacement by using diagnostics (e.g. NEO System Diagnostics, see Section 51.1)
- 1) Dieses Produkt muss nach dem Austausch mit Hilfe von Diagnosesystemen kalibriert werden (z.B. NEO System Diagnose, siehe Abschnitt 51.1)
- 1) Ce produit doit être recalibré après remplacement en utilisant un outil de diagnostic (ex. NEO Systems Diagnostics, voir Section 51.1)
- 1) Dopo la sostituzione questo prodotto deve essere calibrato con uno strumento diagnostico (es: Sistema NEO, vedi sezione 51.1)

Legend	Legende	Légende	Legenda	
A	Reservoir supply port	Vorratsbehälteranschluss	Raccord de réservoir	Raccordo di serbatoio
A ₁	Integral reservoir	Integrierter Vorratsbehälter	Réservoir intégré	Serbatoio integrato
B	Hydraulic delivery	Hydraulischer Ausgang	Sortie Hydraulique	Alimentazione idraulica
C	Piston Ø	Kolben Ø	Ø du piston	Ø Stantuffo
D	Piston area	Kolbenwirkfläche	Section du piston	Area pistone
E	Stroke	Hub	Course	Corsa
F	Stroke switch fitted	Mit Hubwarnschalter	Indicateur de fin de course	Con interruttore di fine corsa
G	Electrical connector	Elektrischer Anschluss	Connecteur électrique	Connessione elettrica
G ₁	AMP 282105-1	AMP 282105-1	AMP 282105-1	AMP 282105-1
G ₂	AMP Serie 150	AMP Serie 150	AMP Serie 150	AMP Serie 150

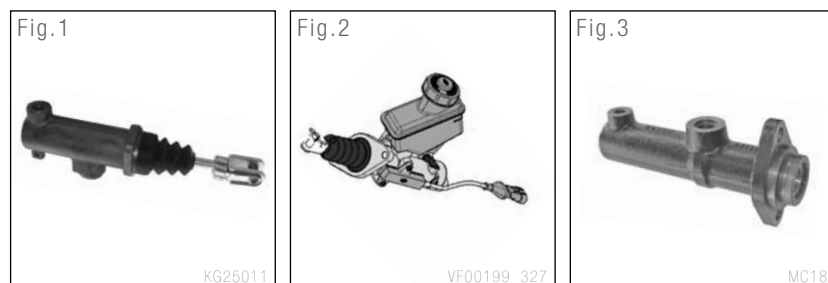

Part Number	Type Number	Fig.	A	B	C [mm]	D [mm ²]	E [mm]	F	G
KG25011.0.1	-	1	Ø 11,3	M14x1,5	25,0		31,0	-	-
K015310	MC1A	2	A ₁	M14x1,5		8,03	42,0	1	G ₁
K013984	MC1D	2	A ₁	M14x1,5		8,03	42,0	2	G ₁
K029301N00	MC2AKR		A ₁	M14x1,5		8,03	42,0	-	-
K029411N00	MC2AR	2	A ₁	M14x1,5		8,03	42,0	1	G ₂
K022011N00	MC2B	2	A ₁	M14x1,5		8,03	42,0	2	G ₁
K023831N00	MC3A	2	A ₁	M14x1,5		5,06	42,0	1	G ₂
1194186	MC18	3	M18x1,5	M12x1,5	28,57		50,3	-	-
758188.01SP	MC19	3	M18x1,5	M12x1,5	31,75		50,3	-	-
1189421SP	MC20	3	M18x1,5	M12x1,5	33,34		50,3	-	-

45 (45.5)

Master Cylinders (Kongsberg)

Geberzylinder (Kongsberg)

Maîtres cylindres (Kongsberg)

Cilindri Maestro (Kongsberg)

	Legend	Legende	Légende	Legenda
H2	Hydraulic delivery	Hydraulischer Ausgang	Sortie Hydraulique	Alimentazione idraulica
A	Servo piston Ø	Kolben Ø	Ø du piston	Ø Stantuffo
B	Stroke	Hub	Course	Corsa



Part Number	Type Number	Fig.	H2	A [mm]	B [mm]
623104AM	–	1	1/2" UNF	26	31
623105AM	–	1	1/2"UNF	28	28
623106AM	–	2	1/2"UNF	26	31
623109AM	–	3	M14x1,5	26	36
623160AM	–	3	M14x1,5	24	36
624503AM	–	4	M12x1,5	26	31
625536AM	–		M12x1,5	28	32
625826AM	–	5	1/2" UNF	26	31
626159AM	–	6	M14x1,5	28	32
626565AM	–	2	M14x1,5	26	31
626760AM	–	7	M14x1,5	26	34
626761AM	–	7	M14x1,5	24	31
626762AM	–	8	M14x1,5	22	36
629298AM	–				

Legend		Legende		Légende		Legenda	
A	Supply	Eingang		Alimentation		Alimentazione	
B	Push rod thread	Kolbenstangengewinde		Tige filetée		Filettatura dell'asta di spinta	
B ₁	Spherical end	Kugelpfanne		Extrémité Sphérique		Con guida a sfera	
C	Stroke	Hub		Course		Corsa	



Part Number	Type Number	Fig.	A	B	C [mm]
K010198	SC2CK	1	M14x1,5	M12x1,25	67
K009936	SC4A	1	M14x1,5	M12x1,25	67
K017419N00	SC5A	2	M14x1,5	B ₁	85
K017436N00	SC6A	2	M14x1,5	B ₁	85

45 (45.7)

Clutch Actuating Modules
Kupplungskraftverstaeker

Servo Embrayage
Moduli Attuazione Frizione

	Legend	Legende	Légende	Legenda
A	Master cylinder	Geberzylinder	Maître cylindre	Cilindri maestro
B	Slave cylinder	Nehmerzylinder	Cylindre de travail	Cilindri attuatori

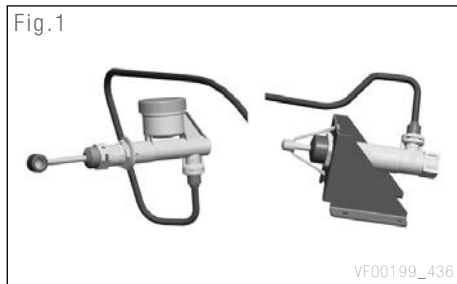

Part Number	Type Number	Fig.	A	B
K009090N00	CAM1AS	1	K009017	K009130
K026949N00	CAM1BS	1	K009017	K027440

	Page
46.1 Gear Change Servo Valves	218
46.2 Gear Change Servos	219
46.3 Gear Lever Actuators (Kongsberg)	220
46.4 Gear Shift Cylinders (Kongsberg)	221
	Seite
46.1 Getriebeschaltventile	218
46.2 Schalthilfe	219
46.3 Schalthebelgeberzylinder (Kongsberg)	220
46.4 Schaltzylinder (Kongsberg)	221
	Page
46.1 Valves de Changement de Vitesse	218
46.2 Servos Changement de Vitesse	219
46.3 Actionneurs de Levier de Vitesse (Kongsberg)	220
46.4 Actionneurs de Selection de Vitesse (Kongsberg)	221
	Pagina
46.1 Valvole Comando Cambio	218
46.2 Servocomando Cambio	219
46.3 Attuatori Leva del Cambio (Kongsberg)	220
46.4 Cilindri Selettore Cambio (Kongsberg)	221

46 (46.1)

Gear Change Servo Valves
Getriebeschaltventile

Valves de Changement de Vitesse
Valvole Comando Cambio

Legend	Legende	Légende	Legenda
A1 Supply	Eingang	Alimentation	Alimentazione
A2 Delivery	Ausgang	Sortie	Uscita

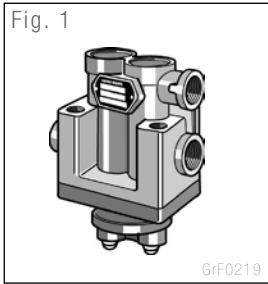

Part Number	Type Number	Fig.	A	
			1	2
AC285B	-	1	M12x1,5	M12x1,5

	Legend	Legende	Légende	Legenda
A	Port size	Anschlussgewinde	Raccord	Raccordi
B	Supply pressure	Betriebsdruck - Eingang	Pression d'alimentation	Pressione alimentazione
C	Operating pressure	Betriebsdruck	Pression de fonctionnement	Pressione di esercizio

Fig. 1

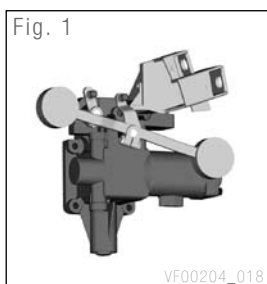

Part Number	Type Number	Fig.	A	B [bar]	C [bar]
GCM1B	–	1	M12x1,5 & M16x1,5	10	4,0 - 6,5
GCM1C	–	1	M12x1,5 & M16x1,5	10	4,0 - 6,5
GCM1E	–	1	M12x1,5 & M16x1,5	10	4,0 - 6,5
K011287	–	1	M12x1,5 & M16x1,5	10	4,0 - 6,5

46 (46.3)

Gear Lever Actuators (Kongsberg)
Schalthebelgeberzylinder (Kongsberg)

Actionneurs de Levier de Vitesse (Kongsberg)
Attuatori Leva del Cambio (Kongsberg)

Legend	Legende	Légende	Legenda	
A	Reservoir supply port	Vorratsbehälteranschluss	Raccord de réservoir	Raccordo di serbatoio
A ₁	Integral reservoir	Integrierter Vorratsbehälter	Réservoir intégré	Serbatoio integrato
B	Number of delivery ports	Anzahl Ausgänge	Numéro des orifices de sortie	Numero di porte
C	Electrical connector	Elektrischer Anschluss	Connecteur électrique	Connessione elettrica
C ₁	DIN 72585	DIN 72585	DIN 72585	DIN 72585

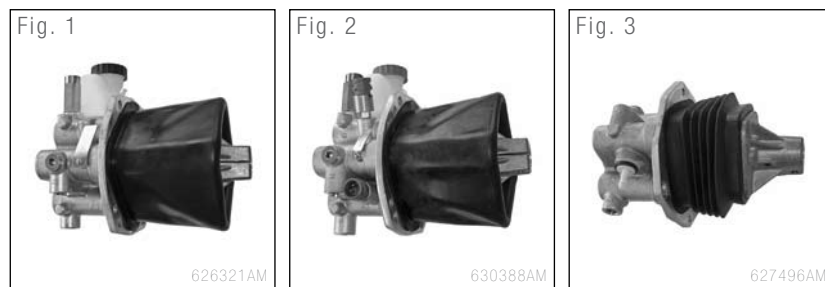

Part Number	Type Number	Fig.	A	B	C
626321AM	–	1	A ₁	4	-
626662AM	–	2	A ₁	4	C ₁
627496AM	–	3	Ø 10,0	4	-
630388AM	–	2	A ₁	4	C ₁

Gear Select Cylinders (Kongsberg)
Schaltzylinder (Kongsberg)

Cylindres de Selection de Vitesse (Kongsberg)
Cilindri Selettore Cambio (Kongsberg)

	Legend	Legende	Légende	Legenda
A	Port size	Anschlussgewinde	Raccord	Raccordi
B	Medium	Betriebsmedium	Moyen	Medio
B ₁	Hydraulic	Hydraulik	Hydraulique	Idraulico
B ₂	Air/hydraulic	Luft/ Hydraulik	Air/hydraulique	Aria/idraulico
C	Electrical connector	Elektrischer Anschluss	Connecteur électrique	Connessione elettrica
C ₁	DIN 72585	DIN 72585	DIN 72585	DIN 72585

Fig. 1



Fig. 2

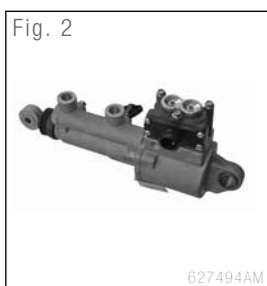
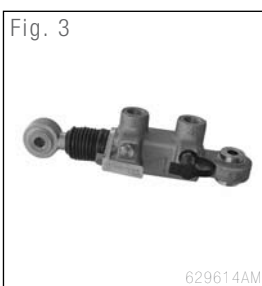

Fig. 3



Part Number	Type Number	Fig.	A	B	C
626597AM	-	1	M16X1,5	B ₁	-
627494AM	-	2	M16X1,5	B ₂	C ₁
629614AM	-	3	M16X1,5	B ₁	-

Legend	Legende	Légende	Legenda
A Supply	Eingang	Alimentation	Alimentazione
B Piston Ø	Kolben-Ø	Ø du piston	Ø Stantuffo
C Push rod thread	Kolbenstangengewinde	Tige filetée	Filettatura dell'asta di spinta
C ₁ Spherical end	Kugelfanne	Extrémité Sphérique	Con guida a sfera
D For vacuum operation	Für Vakuum-Betrieb	Pour fonctionnement sous vide	Per il funzionamento a vuoto
E Stroke	Hub	Course	Corsa



Part Number	Type Number	Fig.	A	B [mm]	C	D	E [mm]
0482005008000	–	1	M12x1,5	30,0	M8x1,25		45
0482005015000	–	2	M12x1,5	30,0	M8x1,25		45
0482005017000	–	3	M12x1,5	30,0	M8x1,25		90
0482005018000	–	4	M12x1,5	30,0	M8x1,25		80
0482006006000	–	5	M12x1,5	35,0	M8x1,25		85
0482006008000	–	5	M12x1,5	35,0	M8x1,25		50
0482006009000	–	6	M12x1,5	35,0	M12x1,5		85
0482006014100	–	7	M12x1,5	35,0	M8x1,25		85
0482018002000	–	5	M12x1,5	35,0	M8x1,25		85
0482020002000	–	8	M10x1,0	18,0	Ø7 mm, C ₁		30
0482020003000	–	8	M10x1,0	18,0	Ø7 mm, C ₁		30
0482020007000	–	9	M12x1,5	22,0	Ø6 mm, C ₁		15
0482020010000	–	9	M12x1,5	22,0	Ø6 mm, C ₁		15
0482024005000	–	10	M10x1,0	28,0	Ø4 mm, C ₁		28
0482102001000	–	11	M12x1,5	60,0	M12x1,5		120
0491060001000	–	12	Ø6 mm	34,5	M6x1,0	D	35
0491060002000	–	12	Ø6 mm	34,5	M6x1,0	D	35
0491060100000	–	13	Ø8 mm	68,5	M8x1,25	D	45
0491060105000	–	14	Ø8 mm	68,5	M8x1,25	D	45
0491060106170	–	13	Ø8 mm	72,0	C ₁	D	48
AC375A	–	15	M10x1,0	18,0	M8x1,25		70
AC398A	–	16	M12x1,5	35,0	M12x1,5		85
AC399A	–	16	M10x1,0	30,0	M8x1,25		40
AC399B	–	16	M10x1,0	30,0	M8x1,25		40
I58893	SZ1115	17	M12x1,5	28,0	M6x1,0		50
I76647	SZ1136	16	M12x1,5	28,0	M8x1,25		48
I83151	SZ1145	16	M12x1,5	28,0	M8x1,25		25
I87236	SZ1152	17	M12x1,5		M6x1,0		32/20
I85564	SZ1159	17	M12x1,5	24,0	M8x1,25		32/50
I90948	SZ1161	16	M12x1,5	28,0	M8x1,25		48
I94326	SZ1166	16	M12x1,5	30,0	M8x1,25		48
II32920	SZ1190	16	M12x1,5	50,0	M10x1,25		48

	Page
48.1 ECU, Wireless Gateway Receivers	225
48.2 Tyre Sensor, Transmitter	226
48.3 External Antenna	226
48.4 Cab Equipment	226
48.5 Tools	227

	Seite
48.1 ECU, Drahtlose Schnittstellen-Empfänger	225
48.2 Drucksensor	226
48.3 Externe Antenne	226
48.4 Fahrerhausausrüstung	226
48.5 Werkzeuge	227

	Page
48.1 ECU, Boitier de Reception Sans Fil	225
48.2 Capteur de Pneu, Emetteur	226
48.3 Antenne Externe	226
48.4 Equipement Cabine	226
48.5 Outils	227

	Pagina
48.1 ECU, Ricevitori Gateway Wireless	225
48.2 Sensore Pneumatico, Trasmittitore	226
48.3 Antenna Esterna	226
48.4 Equipaggiamento Cabina	226
48.5 Strumentazioni	227

Tyre Pressure Monitoring System (TPMS)
Reifendrucküberwachungssystem (TPMS)

Système de Surveillance de la Pression des Pneus
Tyre Pressure Monitoring System (TPMS)

Legend	Legende	Légende	Legenda	
A	Voltage Range	Nennspannung	Plage de Tension	Range di Tensione
B	Pressure Range	Druckmessbereich	Plage de Pression	Range di Pressione
C	Electrical connection	Elektrischer Anschluss	Connexion électrique	Connessione elettrica
C ₁	TYCO AMP Superseal 1473711-1	TYCO AMP Superseal 1473711-1	TYCO AMP Superseal 1473711-1	TYCO AMP Superseal 1473711-1
C ₂	TNC	TNC	TNC	TNC
C ₃	Deutsch DT06-6S	Deutsch DT06-6S	Deutsch DT06-6S	Deutsch DT06-6S
C ₄	Lucar	Lucar	Lucar	Lucar
D	Tool	Einheit	Outil	Strumentazione
D ₁	Maintenance Tool	Konfigurations-Einheit	Outil de Maintenance	Attrezzo di riparazione
D ₂	LF Tool	Service-Einheit	Outil LF	Attrezzo LF
E	Application	Anwendung	Application	Applicazione
E ₁	Truck	Lastkraftwagen	Camion	Camion
E ₂	Bus	Bus	Bus	Bus
E ₃	Trailer	Anhänger	Remorque	Rimorchio

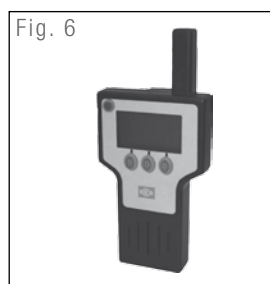
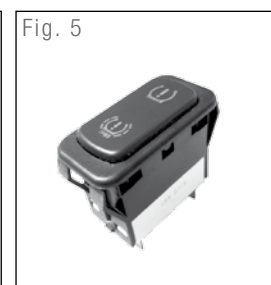
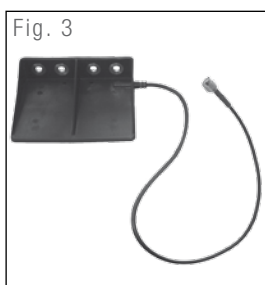

48.1

ECU, Wireless Gateway Receivers

ECU, Drahtlose Schnittstellen-Empfänger

ECU, Boitier de Reception Sans Fil

ECU, Ricevitori Gateway Wireless

Part Number	Type Number	Fig.	A [V]	C	E
201.0013	–	1	9 - 36	C ₁ , C ₂	E ₁ , E ₂
201.0014	–	1	9 - 36	C ₁ , C ₂	E ₃

48 (48.2 - 48.4)

Tyre Pressure Monitoring System (TPMS)
Reifendrucküberwachungssystem (TPMS)

Système de Surveillance de la Pression des Pneus
Tyre Pressure Monitoring System (TPMS)

48.2

Tyre Sensor, Transmitter
Reifendrucksensor, Sender
Capteur de Pneu, Emetteur
Sensore Pneumatico, Trasmittitore

Part Number	Type Number	Fig.	B [bar]	E
201.0007	–	2	0 - 13	E ₁ , E ₂ , E ₃

48.3

External Antenna
Externe Antenne
Antenne Externe
Antenna Esterna

Part Number	Type Number	Fig.	C	E
240.0162	–	3	C ₂	E ₁ , E ₂ , E ₃

48.4

Cab Equipment
Fahrerhausausrüstung
Equipement Cabine
Equipaggiamento Cabina

Part Number	Type Number	Fig.	A [V]	C	E
200.0179	–	4	9 - 36	C ₃	E ₁ , E ₂ , E ₃
256.0035	–	5	9 - 36	C ₄	E ₁ , E ₂

Tyre Pressure Monitoring System (TPMS)
Reifendrucküberwachungssystem (TPMS)

Système de Surveillance de la Pression des Pneus
Tyre Pressure Monitoring System (TPMS)

48.5

Tools

Werkzeuge

Outils

Strumentazioni

Part Number	Type Number	Fig.	D	E
090.0011	–	6	D ₁	E ₁ , E ₂ , E ₃
090.0021	–	7	D ₂	E ₁ , E ₂ , E ₃

Legend	Legende	Légende	Legenda
A Thread size	Anschlussgewinde	Raccord	Filettatura

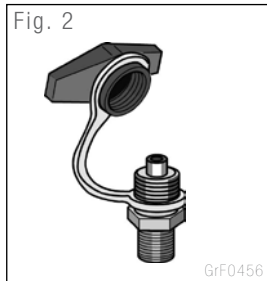



Part Number	Type Number	Fig.	A
0484204001000	-	1	M12x1,5
AC784B	-	2	M16x1,5
KW3405/1	-	2	1/4" NPTF
KW3405/2	-	2	3/8" NPTF
KW4282/2	-	2	M16x1,5

	Page
50.1 NEO System Diagnostics	230
50.2 Air Disc Brake Tool Kits	232
	Seite
50.1 NEO System Diagnose	230
50.2 Werkzeuge für pneumatische Scheibenbremse	232
	Page
50.1 Système de Diagnostic NEO	230
50.2 Kits d'Outil pour Frein à Disque	232
	Pagina
50.1 Sistema Diagnostico NEO	230
50.2 Attrezzature per la Riparazione dei Freni a Disco	232

	Description Beschreibung	Description Descrizione	
The NEO System Diagnostics provides the ultimate in flexibility, allowing entry at any level or upgrade to any level without redundancy of existing diagnostic equipment.	Das NEO System Diagnose bietet äußerste Flexibilität und erlaubt den Einstieg auf jedem Niveau oder die Nachrüstung auf jedes Niveau, ohne dass vorhandene Diagnoseausrüstung veraltet.	Le Système de Diagnostic NEO est d'une grande flexibilité, adaptable ou complémentaire à tout niveau de diagnostic sans redondance avec d'autres équipements existants.	Il Sistema Diagnostico NEO fornisce il massimo in termini di flessibilità nel campo dalle attrezzature diagnostiche, consentendo il collegamento o l'aggiornamento a qualsiasi livello.
To see the range of diagnostic cables and diagnostic software available and for more information on the NEO System Diagnostics contact your local Knorr-Bremse representative.	Wenn Sie die verfügbare Auswahl von Diagnosekabeln und Diagnose-Software und weitere Informationen über das NEO System Diagnose einsehen wollen, wenden Sie sich bitte an eine Knorr-Bremse Niederlassung in Ihrer Nähe.	Pour voir la gamme des câbles et des logiciels de diagnostic disponibles, et pour plus d'information sur le système de Diagnostic NEO, contactez votre représentant local Knorr-Bremse.	Per informazioni sulla gamma di cavi diagnostici e software di diagnostica disponibili e per ulteriori informazioni sul sistema di diagnosi NEO contattate il rappresentante locale Knorr-Bremse.



NEO | green

Part Number	Product Produkt Produit Prodotti	Fig.
K019470N00	NEO green Starter Kit NEO green Starter Kit Kit de Base NEO green NEO green Kit Base	
K025340N00	NEO green Upgrade Kit (upgrade from ECUtalk®) NEO green Upgrade Kit (Ergänzung zu ECUtalk®) Kit adaptable NEO green (complémentaire à ECUtalk®) NEO green Kit d'aggiornamento (da ECUtalk®)	

NEO | orange

Part Number	Product Produkt Produit Prodotti	Fig.
K019471N00	NEO orange Starter Kit NEO orange Starter Kit Kit de Base NEO orange NEO orange Kit Base	

NEO | *blue*

Part Number	Product Produkt Produit Prodotti	Fig.
K019472N00	<p>NEO <i>blue</i> Upgrade Kit (upgrade from NEO <i>orange</i>)</p> <p>NEO <i>blue</i> Upgrade Kit (Ergänzung zu NEO <i>orange</i>)</p> <p>Kit Adaptable NEO <i>blue</i> (Complémentaire à NEO <i>orange</i>)</p> <p>NEO <i>blue</i> Kit d'aggiornamento (aggiornamento dal NEO <i>orange</i>)</p>	
K018605N00	<p>NEO <i>blue</i> Upgrade Kit (upgrade from MTS)</p> <p>NEO <i>blue</i> Upgrade Kit (Ergänzung zu MTS)</p> <p>Kit Adaptable NEO <i>blue</i> (Complémentaire au MTS)</p> <p>NEO <i>blue</i> Kit d'aggiornamento (aggiornamento da MTS)</p>	

NEO | *trailer*

Part Number	Product Produkt Produit Prodotti	Fig.
K019467N00	<p>NEO <i>trailer</i> Starter Kit</p> <p>NEO <i>trailer</i> Starter Kit</p> <p>Kit de Base NEO <i>trailer</i></p> <p>NEO <i>trailer</i> Kit Base</p>	

50 (50.2)

Air Disc Brake Tool Kits

Werkzeuge für pneumatische Scheibenbremse

Kits d'Outil pour Frein à Disque

Attrezzature per la Riparazione dei Freni a Disco

Disc Brakes	Tool Kit/Werkzeuge/ Kits d'Outil/Attrezzature	Part Number		Service Manual/ Serviceanleitung/ Manuel d'Entretien/ Manuale di Servizio
		Alternative/Alternative/ Alternative/Alternativa		
SB5... SB6... SB7...	II37951004 II37951004EN			C16352
SN5...	K004789			Y015044
SN6... SK7... SN7...	K039062K50	K000469 + K017062 + K046291K50 K001288 + K017062 + K046291K50 K005972 + K017062 + K046291K50 K005973 + K017062 + K046291K50 K016947 + K046291K50		Y006471
SL7... SM7...	K039062K50	K016947 + K046291K50		Y081564

K004789



K039062K50



	Page
Index – Products	
Part Number order	234
Type Number order	299
	Seite
Verzeichnis – Produkte	
Nach Teilenummern geordnet	234
Nach Typnummern geordnet	299
	Page
Index – Produits	
Classification par Numéro	234
Classification par Type	299
	Pagina
Indice – Prodotti	
Ordinati per Codice	234
Ordinati per Catalogo	299

	Legend	Legende	Légende	Legenda
1)	No longer in production	Wird nicht mehr hergestellt	Plus produit	Non più in produzione
2)	Currently not available for the Independent Aftermarket	Für den unabhängigen Nachmarkt derzeit nicht erhältlich	Pas disponible pour le marché indépendant	Al momento non disponibile per l'Aftermarket

Products in Part Number order
Produkte, nach Teilenummern geordnet

Classification des Produits par Numero
Prodotti ordinati per Codice

Part Number	Type Number	Replacement/Remplacé par Ersatz / Sostituito da	Page	Part Number	Type Number	Replacement/Remplacé par Ersatz / Sostituito da	Page
0265004011170	–	²⁾	85	0481007029	–	²⁾ 0481007029000	74
0265004012170	–	²⁾	85	0481007029000	–		74
0265004015170	–	²⁾	85	0481007031000	–		74
0265004016170	–	²⁾	85	0481007035	–	²⁾ 0481007035000	74
0265050004	–	¹⁾ 0486000102000	85	0481007035000	–		74
0265050102170	–	²⁾	85	0481007036	–	²⁾ 0481007036000	74
0265050103170	–	²⁾	85	0481007036000	–		74
0265050109031	–		85	0481007039	–	²⁾ 0481007039000	74
0265050110031	–		85	0481007039000	–		74
0265050112000	–		85	0481007043000	–		74
0265050118170	–	²⁾	85	0481007046	–	²⁾ 0481007046000	74
0265050119170	–	²⁾	85	0481007046000	–		74
0265050129	–	¹⁾ 0486000222100	86	0481007047	–	²⁾ 0481007047000	74
0265050132	–	²⁾ 0486000191170	86	0481007047000	–		74
0265050141000	–		85	0481007049	–	²⁾ 0481007049000	74
0265050142000	–		85	0481007049000	–		74
0265050149	–	¹⁾ 0486000135000	86	0481007057	–	²⁾ 0481007057000	74
0265050151	–	¹⁾ 0486000137000	86	0481007057000	–		74
0265150315181	–		81	0481007060	–	²⁾ 0481007060000	74
0265150328000	–		81	0481007060000	–		74
0265151209	–	¹⁾ K004246 (ES1305)	89, 92	0481007501	–	²⁾ 0481007501100	74
0265351101	–	²⁾ K015677N00	83	0481007501100	–		74
0265351102	–	¹⁾ K015676N00	83	0481007503	–	²⁾ 0481007503000	74
0265351104	–	¹⁾ I138659F (BR9163)	83	0481007503000	–		74
0265351107100	–		83	0481009014	–	²⁾ 0481009014000	42
0265351108	–	¹⁾ K015677N00	83	0481009014000	–		42
0265351114	–	¹⁾ K015677N00	83	0481009017	–	²⁾ 0481009017000	42
0265351118	–	²⁾ I117776N00 (BR9154)	83	0481009017000	–		42
0265351122	–	¹⁾ I117776N00 (BR9154)	83	0481009018	–	²⁾ 0481009018000	42
0481007002	–	¹⁾ 0481007023000	74	0481009018000	–		42
0481007005	–	¹⁾ 0481007031000	74	0481009020	–	²⁾ 0481009020000	42
0481007008100	–		74	0481009020000	–		42
0481007009	–	¹⁾ 0481007029000	74	0481009021	–	²⁾ 0481009021000	42
0481007011	–	¹⁾ 0481007023000	74	0481009021000	–		42
0481007012	–	²⁾ 0481007012000	74	0481009022	–	²⁾ 0481009022000	42
0481007012000	–		74	0481009022000	–		42
0481007016	–	²⁾ 0481007016000	74	0481009023	–	²⁾ 0481009023000	42
0481007016000	–		74	0481009023000	–		42
0481007017	–	¹⁾ 0481007049000	74	0481009026	–	²⁾ 0481009026000	42
0481007020	–	²⁾ 0481007031000	74	0481009026000	–		42
0481007021	–	¹⁾ 0481007049000	74	0481009029	–	²⁾ 0481009029000	42
0481007022	–	²⁾ 0481007022000	74	0481009029000	–		42
0481007022000	–		74	0481009032	–	²⁾ 0481009032000	42
0481007023000	–		74	0481009032000	–		42
0481007027	–	²⁾ 0481007027000	74	0481009034	–	²⁾ 0481009034000	42
0481007027000	–		74	0481009034000	–		42
0481007028	–	²⁾ 0481007028000	74	0481009036	–	²⁾ 0481009036000	42
0481007028000	–		74	0481009036000	–		42

Products in Part Number order
Produkte, nach Teilenummern geordnet

Classification des Produits par Numero
Prodotti ordinati per Codice

Part Number	Type Number	Replacement/Remplacé par Ersatz / Sostituito da	Page	Part Number	Type Number	Replacement/Remplacé par Ersatz / Sostituito da	Page
0481009039	-	²⁾ 0481009039000	42	0481019007000	-		31
0481009039000	-		42	0481019008	-	²⁾ 0481019008000	31
0481009040	-	²⁾ 0481009040000	42	0481019008000	-		31
0481009040000	-		42	0481019101	-	²⁾ 0481019101000	27
0481009047	-	²⁾ 0481009047000	42	0481019101000	-		27
0481009047000	-		42	0481026004	-	¹⁾ 0481026006000	60
0481009050	-	²⁾ 0481009050000	42	0481026005	-	²⁾ 0481026005000	60
0481009050000	-		42	0481026005000	-		60
0481009055	-	²⁾ 0481009055000	43	0481026006	-	²⁾ 0481026006000	60
0481009055000	-		43	0481026006000	-		60
0481009056	-	²⁾ 0481009056000	43	0481026008	-	²⁾ 0481026008000	60
0481009056000	-		43	0481026008000	-		60
0481009059	-	²⁾ 0481009059000	43	0481026009	-	²⁾ 0481026021000	60
0481009059000	-		43	0481026010	-	²⁾ 0481026021000	60
0481009061	-	²⁾ 0481009061000	43	0481026012	-	²⁾ 0481026012000	60
0481009061000	-		43	0481026012000	-		60
0481009063	-	²⁾ 0481009063000	43	0481026013	-	²⁾ 0481026013000	60
0481009063000	-		43	0481026013000	-		60
0481009064	-	¹⁾ 0481009029000	42	0481026014	-	¹⁾ 0481026022000	60
0481009065	-	²⁾ 0481009065100	43	0481026015	-	²⁾ 0481026021000	60
0481009065100	-		43	0481026016	-	¹⁾ 0481026021000	60
0481009067	-	²⁾ 0481009067000	43	0481026021	-	²⁾ 0481026021000	60
0481009067000	-		43	0481026021000	-		60
048100906905T	-	²⁾	43	0481026022	-	²⁾ 0481026022000	60
048100907105T	-	²⁾	43	0481026022000	-		60
0481009101	-	¹⁾ 0481009018000	42	0481026023	-	²⁾ 0481026023000	60
048100910222E	-		43	0481026023000	-		60
0481014002	-	¹⁾ I75598 (AE5115)	70	0481026026	-	²⁾ 0481026026000	60
0481014003	-	¹⁾ I75598 (AE5115)	70	0481026026000	-		60
0481015002	-	²⁾ 0481015002000	72	0481026027	-	²⁾ 0481026027000	60
0481015002000	-		72	0481026027000	-		60
0481015003	-	²⁾ 0481009067000	43	04810260302E4	-	²⁾	60
0481015003100	-		72	04810260312E4	-	²⁾	60
0481016101	-	¹⁾ 0481016106000	52	0481026032	-	¹⁾ AC574A	60
0481016106	-	²⁾ 0481016106000	52	0481026301	-	¹⁾ 0481026306000	60
0481016106000	-		52	0481026302	-	²⁾ 0481026302000	60
0481016113	-	²⁾ 0481016113000	52	0481026302000	-		60
0481016113000	-		52	0481026303	-	¹⁾ 0481026307000	60
0481016117	-	²⁾ 0481016117000	52	0481026304	-	²⁾ 0481026307000	60
0481016117000	-		52	0481026305	-	¹⁾ 0481026306000	60
0481016201	-	²⁾ 0481016201000	52	0481026306	-	²⁾ 0481026306000	60
0481016201000	-		52	0481026306000	-		60
0481016209000	-		52	0481026307	-	²⁾ 0481026307000	60
0481016603	-	²⁾ 0481016603000	52	0481026307000	-		60
0481016603000	-		52	0481026505	-	²⁾	60
0481019002	-	²⁾ I94095 (EE1100)	31	0481027104	-	²⁾ 0481027104000	40
0481019003	-	²⁾ 0481019003000	31	0481027104000	-		40
0481019003000	-		31	0481036205	-	¹⁾ 0481036206000	57

Products in Part Number order
Produkte, nach Teilenummern geordnet

Classification des Produits par Numero
Prodotti ordinati per Codice

Part Number	Type Number	Replacement/Remplacé par Ersatz / Sostituito da	Page	Part Number	Type Number	Replacement/Remplacé par Ersatz / Sostituito da	Page
0481036206000	–		57	0481061220000	–		64
0481036207	–	¹⁾ 0481036206000	57	0481061226	–	²⁾ 0481061226000	64
0481039101	–	²⁾ 0481039240000	34	0481061226000	–		64
0481039201	DR3500	²⁾ 0481039201000 (DR3500)	35	0481061230	–	²⁾ 0481061230000	64
0481039201000	DR3500		35	0481061230000	–		64
0481039209000	DR3502		35	0481061231	–	²⁾ 0481061231000	64
0481039210	–	²⁾ 0481039210000	34	0481061231000	–		64
0481039210000	–		34	0481061233	–	²⁾ 0481061233000	64
0481039213	–	²⁾ 0481039213000 (DR3503)	35	0481061233000	–		64
0481039213000	DR3503		35	0481061248	–	²⁾ 0481061248000	64
0481039218000	–		34	0481061248000	–		64
0481039219000	–		34	0481062004	–	¹⁾ 0481062104000	40
0481039221000	–		34	0481062005	–	¹⁾ 0481062308000	40
0481039222000	DR3201		35	0481062008	–	²⁾ 0481062308000	40
0481039234	–	²⁾ 0481039234000	34	0481062011	–	²⁾ 0481062104000	40
0481039234000	–		34	0481062104000	–		40
0481039235000	DR3510		35	0481062105	–	²⁾ 0481062308000	40
0481039240000	–		34	0481062108	–	²⁾ 0481062308000	40
0481039241	–	²⁾ 0481039241000	34	0481062109	–	²⁾ 0481062309000	40
0481039241000	–		34	0481062116170	–	²⁾	40
0481039242000	DR3203		35	0481062308000	–		40
0481039251000	–		34	0481062309000	–		40
0481039252000	DR3218		35	0481062310	–	²⁾ 0481062310000	40
0481039257000	DR3224		35	0481062310000	–		40
0481039258	–	²⁾ 0481039258000 (DR3232)	35	0481062317	–	²⁾ 0481062317000	40
0481039258000	DR3232		35	0481062317000	–		40
0481039266000	–		34	0481062405000	–		40
0481039268100	DR3575		35	0481062412000	–		40
0481042101	–	¹⁾ 0481042201000	34	0481062413	–	²⁾ 0481062413000	40
0481042106	–	¹⁾ 0481042212000	34	0481062413000	–		40
0481042201000	–		34	0481063004	–	²⁾ K000618 (DR4155)	37
0481042208000	–		34	0481063010	–	²⁾ K000630 (DR4256)	38
0481042209000	–		34	0481063013	–	²⁾ K000643 (DR4377)	38
0481042212	–	²⁾ 0481042212000	34	0481063016	–	²⁾ K000616 (DR4153)	37
0481042212000	–		34	0481063031	–	²⁾ K000647 (DR4381)	38
0481042225000	–		34	0481063033	–	¹⁾ 0481064005000	47
0481061005	–	²⁾ 0481061005000	64	0481063037000	–		37
0481061005000	–		64	0481063041	–	²⁾ K000647 (DR4381)	38
0481061010	–	¹⁾ 0481061214000	64	0481064001	–	¹⁾ 0481064007000	47
0481061012	–	¹⁾ 0481061005000	64	0481064005	–	²⁾ 0481064005000	47
0481061020	–	²⁾ 0481061020000	64	0481064005000	–		47
0481061020000	–		64	0481064007	–	²⁾ 0481064007000	47
0481061206	–	¹⁾ 0481061226000	64	0481064007000	–		47
0481061214	–	²⁾ 0481061214000	64	0481064103	–	²⁾ 0481064103000	47
0481061214000	–		64	0481064103000	–		47
0481061219	–	²⁾ 0481061219000	64	0481064105	–	¹⁾ 0481064115000	47
0481061219000	–		64	0481064106000	–		47
0481061220	–	²⁾ 0481061220000	64	0481064107	–	¹⁾ 0481064108000	47

Products in Part Number order
Produkte, nach Teilenummern geordnet

Classification des Produits par Numero
Prodotti ordinati per Codice

Part Number	Type Number	Replacement/Remplacé par Ersatz / Sostituito da	Page	Part Number	Type Number	Replacement/Remplacé par Ersatz / Sostituito da	Page
0481064108000	-		47	0482005017000	-		223
0481064113	-	²⁾ 0481064113000	47	0482005018000	-		223
0481064113000	-		47	0482006006	-	²⁾ 0482006006000	223
0481064115000	-		47	0482006006000	-		223
0481064117000	-		47	0482006008	-	²⁾ 0482006008000	223
0481064205	-	²⁾ 0481064205000	47	0482006008000	-		223
0481064205000	-		47	0482006009	-	²⁾ 0482006009000	223
0481064603	-	²⁾ 0481064603000	47	0482006009000	-		223
0481064603000	-		47	0482006011	-	¹⁾ 0482018002000	223
0481065002000	-		57	0482006014100	-		223
0481065003	-	¹⁾ 0481065004000	57	0482018002	-	²⁾ 0482018002000	223
0481065004	-	²⁾ 0481065004000	57	0482018002000	-		223
0481065004000	-		57	0482020002000	-		223
0481065101	-	²⁾ 0481065101000	58	0482020003	-	²⁾ 0482020003000	223
0481065101000	-		58	0482020003000	-		223
0481065103	-	²⁾ K022166N00	58	0482020007	-	²⁾ 0482020007000	223
0481065103000	-		58	0482020007000	-		223
0481097007	-	²⁾ 0481097007000	57	0482020010	-	²⁾ 0482020010000	223
0481097007000	-		57	0482020010000	-		223
0481500007	-	²⁾ 0481500007000	185	0482023501	-	¹⁾ 0482023504000	131
0481500007000	-		185	0482023504000	-		131
0481500101	-	²⁾ 0481500101000	185	0482023505	-	¹⁾ 0482023504000	131
0481500101000	-		185	0482023610	-	²⁾ 0482023610000	131
0481500102	-	²⁾ 0481500102000	185	0482023610000	-		131
0481500102000	-		185	0482023708170	-	²⁾	131
0481500103	-	²⁾ 0481500103000	185	0482023809170	-	²⁾	131
0481500103000	-		185	0482023810170	-	²⁾	131
0481500105	-	²⁾ 0481500105000	185	0482023907170	-	²⁾	131
0481500105000	-		185	0482023925170	-	²⁾	131
0481503011	-	²⁾ 0481503011000	185	0482023926170	-	²⁾	131
0481503011000	-		185	0482023927	-	²⁾ 0482023927000	131
0481503018	-	²⁾ 0481503018000	186	0482023927000	-		131
0481503018000	-		186	0482024005	-	²⁾ 0482024005000	223
0481511001	-	²⁾ 0481511001000	186	0482024005000	-		223
0481511001000	-		186	0482025302	-	¹⁾ K015592 (BS3528)	134
0481511002	-	²⁾ 0481511002000	186	0482101002	-	¹⁾ 0482102001000	223
0481511002000	-		186	0482102001	-	²⁾ 0482102001000	223
0481511003	-	¹⁾ 0486206101100	186	0482102001000	-		223
0481511102	-	²⁾ 0481511102100	186	0482512215	-	¹⁾ II16852 (BZ9406)	139
0481511102100	-		186	0482513205	-	¹⁾ II18524000 (BY9104)	144
0481511105	-	²⁾ 048151110513V	186	0482513206	-	¹⁾ II18523000 (BY9103)	144
048151110513V	-		186	0482513301	-	¹⁾ II18526000 (BY9154)	144
0481511106	-	²⁾ 0481511106100	186	0482513302	-	¹⁾ II18525000 (BY9153)	144
0481511106100	-		186	0482513303	-	¹⁾ II18526000 (BY9154)	144
0482005008	-	²⁾ 0482005008000	223	0482513304	-	¹⁾ II18525000 (BY9153)	144
0482005008000	-		223	0482513401	-	¹⁾ II16576000 (BY9201)	144
0482005015000	-		223	0482513402	-	¹⁾ II16576000 (BY9201)	144
0482005017	-	²⁾ 0482005017000	223	0482513406	-	¹⁾ II16576000 (BY9201)	144

Products in Part Number order
Produkte, nach Teilenummern geordnet

Classification des Produits par Numero
Prodotti ordinati per Codice

Part Number	Type Number	Replacement/Remplacé par Ersatz / Sostituito da	Page	Part Number	Type Number	Replacement/Remplacé par Ersatz / Sostituito da	Page
0482513407	–	¹⁾ II16575000 (BY9200)	144	0484205006N00	–		101
0482513551	–	²⁾ K019976N00 (BY9282)	144	0484205007	–	²⁾ 048420500705T	101
0482513552	–	²⁾ K019977N00 (BY9283)	144	048420500705T	–		101
0482513556	–	²⁾ K019976N00 (BY9282)	144	0484210001	–	²⁾ 0484210001000	187
0482513557	–	¹⁾ K019977N00 (BY9283)	144	0484210001000	–		187
0482513604	–	¹⁾ K021178N00 (BY9340)	144	0484210002	–	²⁾ 0484210002000	187
0482513605	–	¹⁾ K021179N00 (BY9341)	144	0484210002000	–		187
0482513606	–	²⁾ K003964N00 (BY9322)	144	0484210004	–	²⁾ 0484210004000	187
0482513607	–	²⁾ K004064N00 (BY9323)	144	0484210004000	–		187
0482513610	–	²⁾ K003964N00 (BY9322)	144	0484210005	–	²⁾ 0484210005000	187
0482513611	–	²⁾ K004064N00 (BY9323)	144	0484210005000	–		187
0482513704	–	²⁾ K020814N00 (BY9338)	144	0484210008000	–		187
0482513908	–	²⁾ K020004N00 (BY9466)	144	0484210009000	–		187
0482513909	–	²⁾ K020005N00 (BY9467)	144	0484210010	–	²⁾ 0484210010000	187
0482514207	–	¹⁾ K007642 (BS9296)	148	0484210010000	–		187
0482514310	–	¹⁾ K007646 (BS9395)	148	0484210015	–	²⁾ 0484210015000	187
048300500405T	–	²⁾	212	0484210015000	–		187
0483005007	–	²⁾ K015875N50	212	0484210016000	–		187
0483005008100	–	²⁾	212	0484210017	–	²⁾ 0484210017000	187
0483005011100	–	²⁾	212	0484210017000	–		187
0484102002	–	¹⁾ K004229 (KU4124)	67	0484210018000	–		188
0484102012	–	¹⁾ K004229 (KU4124)	67	0484351005	–	²⁾ 0484351005000	74
0484102016	–	¹⁾ K004229 (KU4124)	67	0484351005000	–		74
0484102026	–	²⁾ K013662 (KU4124)	67	0484351012	–	²⁾ 0484351012000	74
0484102027	–	²⁾ K004152 (KU4128)	67	0484351012000	–		74
0484102028	–	²⁾ K004229 (KU4124)	67	048435101305T	–	²⁾	74
0484102029	–	²⁾ K004152 (KU4128)	67	0484451013	–	²⁾ 0484451013000	26
0484103106	–	²⁾ 0484103106000	66	0484451013000	–		26
0484103106000	–		66	0484451019000	–		26
0484150101	–	¹⁾ II17355 (KU1311)	67	0484460109	–	¹⁾ I92013 (LA6221)	19
0484150102	–	¹⁾ II17354 (KU1310)	67	0484460111	–	¹⁾ II30448 (LA8234)	21
0484150103	–	¹⁾ II17354 (KU1310)	67	0484460116	–	¹⁾ II30448 (LA8234)	21
0484150111	–	¹⁾ II17354 (KU1310)	67	0484460135	–	¹⁾ II19375 (LA8206)	21
0484150112	–	²⁾ 0484150112000	66	0484460138	–	¹⁾ II19375 (LA8206)	21
0484150112000	–		66	0484460150	–	¹⁾ II30447 (LA8233)	21
0484150113	–	¹⁾ II33263 (KU1305)	67	0484460160	–	¹⁾ II19216 (LA8205)	21
0484150114	–	¹⁾ II33262 (KU1304)	66	0484460165	–	²⁾ 0484451019000	26
0484150117	–	¹⁾ 0484150119000	66	0484460165000	–		19
0484150118	–	¹⁾ 0484150120000	66	0484460170000	–		19
0484150119	–	²⁾ 0484150119000	66	0484460171	–	²⁾ 0484460171000	19
0484150119000	–		66	0484460171000	–		19
0484150120	–	²⁾ 0484150120000	66	0484460173	–	¹⁾ II30447 (LA8233)	21
0484150120000	–		66	0484460177	–	²⁾ 0484460177000	19
0484204001	–	²⁾ 0484204001000	228	0484460177000	–		19
0484204001000	–		228	0484460178	–	¹⁾ II30448 (LA8234)	21
0484205003	–	²⁾ 0484205003750	101	0484460179	–	¹⁾ II31475 (LA8254)	21
0484205003750	–		101	0484460183	–	¹⁾ II31119 (LA8253)	21
0484205004N50	–		101	0484460185	–	¹⁾ II19375 (LA8206)	21

Products in Part Number order
Produkte, nach Teilenummern geordnet

Classification des Produits par Numero
Prodotti ordinati per Codice

Part Number	Type Number	Replacement/Remplacé par Ersatz / Sostituito da	Page	Part Number	Type Number	Replacement/Remplacé par Ersatz / Sostituito da	Page
0484460187	-	¹⁾ II19206 (LA8209)	21	0486000121N00	-		85
0484460188	-	¹⁾ II19207 (LA8210)	21	0486000126	-	²⁾ 0486000126100	85
0484460189	-	¹⁾ II19208 (LA8211)	21	0486000126100	-		85
0484460190	-	¹⁾ II19209 (LA8212)	21	0486000128	-	²⁾ 0486000128100	86
0484460191	-	¹⁾ II19204 (LA8207)	21	0486000128100	-		86
0484460192	-	¹⁾ II19205 (LA8208)	21	0486000129	-	²⁾ 0486000129100	86
0484460193	-	¹⁾ II30185 (LA8228)	21	0486000129100	-		86
0484460196000	-		19	0486000130100	-		86
0484460197	-	¹⁾ II30448 (LA8234)	21	0486000132	-	²⁾ 0486000132100	86
0484460198	-	¹⁾ II30185 (LA8228)	21	0486000132100	-		86
0484460202170	-	²⁾	19	0486000133000	-		86
04860000192E4	-		85	0486000134	-	²⁾ 0486000134000	86
0486000039	-	²⁾ 0486000039000	85	0486000134000	-		86
0486000039000	-		85	0486000135000	-		86
0486000040	-	²⁾ 0486000040000	85	0486000136000	-		86
0486000040000	-		85	0486000137000	-		86
0486000041	-	²⁾ 0486000182100	86	0486000180100	-	²⁾	86
0486000042	-	²⁾ 0486000183100	86	0486000181100	-		86
0486000071	-	²⁾ 0486000071000	85	0486000182100	-		86
0486000071000	-		85	0486000183100	-		86
0486000072	-	²⁾ 0486000072000	85	0486000184100	-	²⁾	86
0486000072000	-		85	0486000191170	-	²⁾	86
0486000100	-	²⁾ 0486000100N00	85	0486000222100	-		86
0486000100N00	-		85	0486000237	-	²⁾ 0486000237N00	86
0486000101	-	²⁾ 0486000101N00	85	0486000237N00	-		86
0486000101N00	-		85	0486000238	-	²⁾ 0486000238N00	86
0486000102000	-		85	0486000238N00	-		86
0486000103	-	²⁾ 0486000103N00	85	0486000239	-	²⁾ 0486000239N00	86
0486000103N00	-		85	0486000239N00	-		86
0486000104	-	²⁾ 0486000104N00	85	0486000240	-	²⁾ 0486000240N00	86
0486000104N00	-		85	0486000240N00	-		86
0486000105000	-		85	0486000241	-	²⁾ 0486000241N00	86
0486000106	-	²⁾ 0486000106N00	85	0486000241N00	-		86
0486000106N00	-		85	0486000242	-	²⁾ 0486000242N00	86
0486000107	-	²⁾ 048600010705T	85	0486000242N00	-		86
048600010705T	-	²⁾	85	0486000243	-	²⁾ 0486000243N00	86
0486000108	-	²⁾ 0486000108000	85	0486000243N00	-		86
0486000108000	-		85	0486000244	-	²⁾ 0486000244181	86
0486000109	-	²⁾ 0486000109000	85	0486000244181	-		86
0486000109000	-		85	0486000245181	-		86
0486000114	-	²⁾ 0486000114999	85	0486000246	-	²⁾ 0486000246N00	86
0486000114999	-		85	0486000246N00	-		86
0486000115	-	²⁾ 0486000115999	85	0486000247100	-		86
0486000115999	-		85	0486000250	-	²⁾ 0486000250N00	86
0486000116100	-		85	0486000250N00	-		86
0486000120	-	²⁾ 0486000120N00	85	0486000251	-	²⁾ 0486000251N00	86
0486000120N00	-		85	0486000251N00	-		86
0486000121	-	²⁾ 0486000121N00	85	0486000252	-	²⁾ 0486000252N00	86

Products in Part Number order
Produkte, nach Teilenummern geordnet

Classification des Produits par Numero
Prodotti ordinati per Codice

Part Number	Type Number	Replacement/Remplacé par Ersatz / Sostituito da	Page	Part Number	Type Number	Replacement/Remplacé par Ersatz / Sostituito da	Page
0486000252N00	-		86	04860010432E4	-	²⁾	87
0486000253	-	²⁾ 0486000253N00	86	0486001064100	-		87
0486000253N00	-		86	0486001066100	-		87
0486000254	-	²⁾ 0486000254N00	86	0486001067	-	²⁾ 0486001080000	87
0486000254N00	-		86	0486001067000	-		87
0486000255	-	²⁾ 0486000255N00	86	0486001068	-	²⁾ 0486001080000	87
0486000255N00	-		86	0486001069	-	²⁾ 0486001080000	87
0486000256	-	²⁾ 0486000256N00	86	0486001070	-	²⁾ 0486001080000	87
0486000256N00	-		86	0486001071	-	²⁾ 0486001080000	87
0486000257	-	²⁾ 0486000257N00	86	0486001072170	-	²⁾	87
0486000257N00	-		86	0486001073170	-	²⁾	87
0486000258	-	²⁾ 0486000258N00	86	0486001074170	-	²⁾	87
0486000258N00	-		86	0486001075170	-	²⁾	87
0486000259	-	²⁾ 0486000259N00	86	0486001076100	-		87
0486000259N00	-		86	0486001077100	-		87
0486000260	-	²⁾ 0486000260N00	86	0486001080000	-		87
0486000260N00	-		86	0486001084N01	-	²⁾	87
0486000261	-	²⁾ 0486000261N00	86	0486002001	-	²⁾ 0486002001000	87
0486000261N00	-		86	0486002001000	-		87
0486000263	-	²⁾ 0486000263N00	86	0486002002	-	²⁾ 0486002002000	87
0486000263N00	-		86	0486002002000	-		87
0486000267	-	²⁾ 0486000275000	87	0486002003	-	²⁾ 0486002003N00	87
0486000268	-	²⁾ 0486000275000	87	0486002003N00	-		87
0486000269	-	²⁾ 0486000275000	87	0486002004	-	²⁾ 0486002004N00	87
0486000270	-	²⁾ 0486000275000	87	0486002004N00	-		87
0486000272170	-	²⁾	86	0486002005N08	-	²⁾	87
0486000273100	-		86	0486020002N50	-		101
0486000273N03	-	²⁾	87	0486020003N50	-		101
0486000275000	-		87	04860200062E4	-	²⁾	101
0486000276	-	²⁾ 0486000276N00	87	0486021003N50	-		102
0486000276N00	-		87	04860210062E4	-	²⁾	102
0486000277	-	²⁾ 0486000277N00	87	0486021007N50	-		102
0486000277N00	-		87	0486021008181	-		102
0486000279N09	-	²⁾	87	0486021009	-	²⁾ 04860210122E4	102
0486000282N03	-	²⁾	87	04860210112E4	-	²⁾	102
0486000284N00	-		87	04860210122E4	-	²⁾	102
0486000285N00	-		87	0486104021	-	²⁾ 0486104021100	81
04860010162E4	-	²⁾	87	0486104021100	-		81
0486001017	-	¹⁾ 0486001064100	87	0486104028	-	²⁾ 0486104028100	81
04860010262E4	-		87	0486104028100	-		81
0486001029	-	²⁾ 0486001032100	87	04861040302E4	-		81
0486001030	-	²⁾ 0486001066100	87	0486104032170	-	²⁾	81
0486001032100	-		87	0486104033181	-	²⁾	81
0486001033100	-		87	0486104034	-	²⁾ 0486104034100	81
0486001041	-	²⁾ 0486001041N00	87	0486104034100	-		81
0486001041N00	-		87	0486104036	-	¹⁾ 0486104118100	81
0486001042	-	²⁾ 0486001042N00	87	0486104039100	-		81
0486001042N00	-		87	0486104045100	-		81

Products in Part Number order
Produkte, nach Teilenummern geordnet

Classification des Produits par Numero
Prodotti ordinati per Codice

Part Number	Type Number	Replacement/Remplacé par Ersatz / Sostituito da	Page	Part Number	Type Number	Replacement/Remplacé par Ersatz / Sostituito da	Page
0486104051100	-		81	0486106090N04	-	²⁾	103
0486104056000	-		81	0486106100N04	-	²⁾	103
0486104063170	-		81	0486106101N04	-	²⁾	104
0486104064170	-	²⁾	81	0486106102N07	-	²⁾	104
0486104103	-	²⁾ 0486104104100	81	0486106103N07	-	²⁾	104
0486104104100	-		81	0486106104N05	-	²⁾	104
0486104106	-	²⁾ 0486104106000	81	0486106105N05	-	²⁾	104
0486104106000	-		81	0486106106	-	²⁾ 0486106106N00	104
0486104109100	-		81	0486106106N00	-		104
0486104110100	-		81	0486106107N00	-		104
0486104115100	-		81	0486106108N03	-	²⁾	104
0486104118100	-		81	0486106109N03	-	²⁾	104
0486104120170	-	²⁾	81	0486106110N06	-	²⁾	104
0486104122170	-	²⁾	81	0486106111N06	-	²⁾	104
0486106010	-	¹⁾ 048610602122E	103	0486106112N06	-	²⁾	104
048610602122E	-	²⁾	103	0486106301N04	-	²⁾	104
0486106027	-	¹⁾ 0486106041181	103	0486107002100	-		81
0486106029	-	¹⁾ 0486106042181	103	0486107007100	-		81
0486106041181	-	²⁾	103	0486107008N01	-	²⁾	81
0486106042181	-	²⁾	103	0486107009N01	-	²⁾	81
0486106050	-	²⁾ 0486106104N05	104	0486107011100	-		81
048610605022E	-		103	0486107012N00	-		81
0486106060	-	²⁾ 0486106107N00	104	0486107103100	-		81
0486106063	-	²⁾ 0486106102N07	104	0486107105	-	²⁾ 0486107105100	81
048610606319Z	-		103	0486107105100	-		81
0486106064	-	²⁾ 0486106103N07	104	0486107106170	-	²⁾	81
048610606419Z	-	²⁾	103	0486107107170	-	²⁾	81
0486106065	-	²⁾ 0486106105N05	104	0486107108100	-		81
048610606522E	-		103	0486107111N00	-		81
0486106070	-	²⁾ 0486106082N04	103	0486107112N01	-	²⁾	81
0486106071	-	²⁾ 0486106083N04	103	0486107114	-	²⁾ 04861071172E4	81
0486106073	-	²⁾ 0486106088N03	103	04861071162E4	-		81
0486106079	-	²⁾ 0486106084N06	103	04861071172E4	-		81
0486106080	-	²⁾ 0486106085N06	103	0486107202N09	-	²⁾	81
0486106081	-	²⁾ 0486106112N06	104	0486107302N00	-		81
0486106081N06	-	²⁾	103	0486107311N01	-	²⁾	81
0486106082N04	-	²⁾	103	0486107313N01	-	²⁾	81
0486106083N04	-	²⁾	103	0486107502N00	-		81
0486106084	-	²⁾ 0486106110N06	104	0486107503N00	-		82
0486106084N06	-	²⁾	103	0486107505N00	-		82
0486106085	-	²⁾ 0486106111N06	104	0486107506N00	-		82
0486106085N06	-	²⁾	103	0486107507N06	-	²⁾	82
0486106086	-	²⁾ 0486106089N04	103	0486107509N06	-	²⁾	82
0486106086N04	-	²⁾	103	0486107510N01	-	²⁾	82
0486106087	-	²⁾ 0486106090N04	103	0486107700N03	-	²⁾	82
0486106087N04	-	²⁾	103	0486200002	-	¹⁾ 0486200009000	98
0486106088N03	-	²⁾	103	0486200004N50	-		98
0486106089N04	-	²⁾	103	0486200005	-	²⁾ 0486200004N50	98

Products in Part Number order
Produkte, nach Teilenummern geordnet

Classification des Produits par Numero
Prodotti ordinati per Codice

Part Number	Type Number	Replacement/Remplacé par Ersatz / Sostituito da	Page	Part Number	Type Number	Replacement/Remplacé par Ersatz / Sostituito da	Page
0486200006	–	¹⁾ K039544N50	99	04862061022E4	–	²⁾	186
0486200007	–	²⁾ K039530N50	99	0486206103	–	²⁾ 0486206103100	186
0486200008	–	¹⁾ 0486200009000	98	0486206103100	–		186
0486200009000	–		98	0486206104	–	²⁾ 0486206104000	186
0486200011	–	²⁾ K039544N50	99	0486206104000	–		186
0486200104N50	–		98	0486206105	–	¹⁾ 04862061022E4	186
0486200105	–	²⁾ 0486200104N50	98	0491051001	–	²⁾ 0491051001170	74
0486200202N50	–		98	0491051001170	–	²⁾	74
0486200203	–	²⁾ 0486200202N50	98	0491060001	–	²⁾ 0491060001000	223
0486201001	–	¹⁾ II17776N00 (BR9154)	83	0491060001000	–		223
0486201003	–	¹⁾ II17776N00 (BR9154)	83	0491060002000	–		223
0486201011181	–	²⁾	83	0491060100000	–		223
0486201015	–	¹⁾ II41053F (BR9190)	83	0491060105	–	²⁾ 0491060105000	223
0486201017170	–	²⁾	83	0491060105000	–		223
0486202001	–	²⁾ 0486202001100	93	0491060106170	–	²⁾	223
0486202001100	–		93	0500004201	–	²⁾ 0500004201000	197
0486203012	–	¹⁾ 0486203023N50	96	0500004201000	–		197
0486203013	–	¹⁾ 0486203023N50	96	050000420419Z	–	²⁾	197
0486203016	–	¹⁾ 0486203023N50	96	0500005001	–	¹⁾ 0491060001000	223
0486203023	–	²⁾ 0486203023N50	96	0500005001000	–		197
0486203023N50	–		96	0500005002	–	²⁾ 0500005002000	197
0486203024	–	²⁾ 0486203033N50	96	0500005002000	–		197
0486203025	–	²⁾ 0486203025N50	96	0500005006	–	²⁾ 0500005006000	197
0486203025N50	–		96	0500005006000	–		197
0486203026	–	²⁾ 0486203025N50	96	0500005007	–	²⁾ 0500005007000	197
0486203030N50	–		96	0500005007000	–		197
0486203031	–	²⁾ 0486203030N50	96	0500005011	–	²⁾ 0500005011000	197
0486203032	–	¹⁾ 0486203023N50	96	0500005011000	–		197
0486203033N50	–		96	0500005012000	–		197
0486204017	–	²⁾ 0486204017N50	97	0500005014	–	¹⁾ 0500005007000	197
0486204017N50	–		97	0500005017	–	²⁾ 0500005017000	197
0486204018	–	²⁾ 0486204025N50	97	0500005017000	–		197
0486204019N50	–		97	0500005101	–	²⁾ 0500005101000	197
0486204020	–	²⁾ 0486204019N50	97	0500005101000	–		197
0486204021N50	–		97	0500005104	–	²⁾ 0500005104000	197
0486204023	–	²⁾ 0486204021N50	97	0500005104000	–		197
0486204025N50	–		97	0500005105000	–		197
0486205008	–	¹⁾ 0486205022N50	100	0501100009	–	²⁾ 0501100009000	204
0486205011	–	¹⁾ 0486205022N50	100	0501100009000	–		204
0486205014N50	–		100	0501100011	–	²⁾ 0501100011000	204
0486205015	–	¹⁾ 0486205022N50	100	0501100011000	–		204
0486205016	–	¹⁾ 0486205022N50	100	0501100014	–	¹⁾ 0501100029000	204
0486205017	–	²⁾ 0486205022N50	100	0501100016	–	²⁾ 0501100041100	204
0486205019	–	²⁾ 0486205022N50	100	050110001613V	–	²⁾	204
0486205020	–	²⁾ 0486205014N50	100	0501100019	–	²⁾ 050110001905T	204
0486205022	–	²⁾ 0486205022N50	100	050110001905T	–	²⁾	204
0486205022N50	–		100	0501100020	–	¹⁾ 0501100031000	204
0486206101100	–		186	0501100021	–	¹⁾ 050110005005T	204

Products in Part Number order
Produkte, nach Teilenummern geordnet

Classification des Produits par Numero
Prodotti ordinati per Codice

Part Number	Type Number	Replacement/Remplacé par Ersatz / Sostituito da	Page	Part Number	Type Number	Replacement/Remplacé par Ersatz / Sostituito da	Page
0501100022	-	¹⁾ 050110005105T	204	0504004114	-	²⁾ 0504004114000	205
0501100023	-	¹⁾ 0501100407100	203	0504004114000	-		205
0501100025	-	²⁾ 0501100025000	204	0504004115	-	²⁾ 0504004115000	205
0501100025000	-	²⁾	204	0504004115000	-	²⁾	205
0501100027	-	²⁾ 0501100027066	204	0504050001	-	²⁾ 0504050001000	203
0501100027066	-		204	0504050001000	-		203
0501100028	-	²⁾ 0501100028066	204	0504050003	-	¹⁾ 0504050008000	203
0501100028066	-		204	0504050004	-	¹⁾ 0504050007000	203
0501100029	-	²⁾ 0501100029000	204	0504050005	-	¹⁾ 0504050008000	203
0501100029000	-		204	0504050007000	-		203
0501100031	-	²⁾ 0501100031000	204	0504050008000	-		203
0501100031000	-		204	0504050009	-	²⁾ K001319N00	203
0501100032	-	²⁾ 0501100038100	204	0504050011	-	²⁾ K001319N00	203
0501100035	-	¹⁾ 0501100041100	204	0821302026234	-		60
0501100037	-	²⁾ 0501100038100	204	090.0011	-		227
050110003719Z	-	²⁾	204	090.0021	-		227
0501100038100	-		204	101275	-	²⁾	37
0501100040	-	²⁾ 0501100029000	204	1013393000	-	¹⁾ SEB01158000 (LP4943)	16
0501100040100	-		204	101487	-	²⁾ 107740	62
0501100041	-	²⁾ 0501100041100	204	102044	-	¹⁾ 229813N	62
0501100041100	-		204	103060	-	²⁾	60
0501100042	-	¹⁾ 0501100401170	203	1031187000	-		27
0501100049	-	¹⁾ 0501100401170	203	104228	-	¹⁾ 277516	75
050110005005T	-	²⁾	204	104229	-	¹⁾ 277516	75
050110005105T	-	²⁾	204	104230	-	¹⁾ 277516	75
0501100401170	-	²⁾	203	104231	-	¹⁾ 277516	75
0501100402170	-	²⁾	203	104232	-	¹⁾ 277516	75
0501100403	-	¹⁾ 0501100401170	203	104234	-	¹⁾ 277516	75
0501100404	-	¹⁾ 0501100402170	203	104263	-	²⁾	74
0501100405	-	¹⁾ 0501100407100	203	1043126000	-		52
0501100407	-	²⁾ 0501100407100	203	1043135000	-		52
0501100407100	-		203	1043137000	-		52
0504002104	-	²⁾ 0504002104000	205	1043138000	-		52
0504002104000	-		205	104576	-	¹⁾ 289714	62
0504002110	-	²⁾ 0504002113100	205	1053222000	-		128
0504002111066	-	²⁾	205	1053223000	-		128
0504002112	-	²⁾ K013741N00	205	106191	-	¹⁾ 277516	75
0504002113	-	²⁾ 0504002113100	205	107740	-	²⁾	62
0504002113100	-		205	109159	-	¹⁾ 274746	191
0504002114000	-		205	109173	-	¹⁾ 283321	71
0504003001	-	²⁾ 0504003001000	199	109216	-	¹⁾ 283321	71
0504003001000	-		199	109649	-	²⁾	15
0504004105	-	²⁾ 0504004105000	205	109914	-	²⁾	192
0504004105000	-		205	1101687000	-		63
0504004106	-	²⁾ 0504004106100	205	1111340000	-		43
0504004106100	-		205	1111381000	-		43
0504004109000	-		205	1111384000	-		43
0504004113	-	²⁾ 0504004115000	205	1111414000	-		75

Products in Part Number order
Produkte, nach Teilenummern geordnet

Classification des Produits par Numero
Prodotti ordinati per Codice

Part Number	Type Number	Replacement/Remplacé par Ersatz / Sostituito da	Page	Part Number	Type Number	Replacement/Remplacé par Ersatz / Sostituito da	Page
1111419000	–		71	1186885-03	–	¹⁾ 1189229-01	126
1111423000	–	¹⁾ KX1294/2	62	1186885-04	–	¹⁾ 1189229-01	126
1111430000	–		75	1186885-05	–	¹⁾ 1189229-01	126
1111437000	–		75	1186892	–		62
1111518000	–		37	1186937	–	¹⁾ II30448 (LA8234)	21
1111519000R	–	²⁾	71	1186938	–		57
1111523000	–	¹⁾ KX1294/2	62	1188230	–		188
1111526000	–	¹⁾ KX1294/2	62	1188729	–	¹⁾ 1185145	33
1111529000	–	¹⁾ KX1294/1	62	1188768	–		47
1111661000	–		186	1188791	–	¹⁾ II19375 (LA8206)	21
1111695000	–		31	1188801	–	¹⁾ II30178 (LA8223)	21
1111995000	–		57	1188823	–	²⁾ K028266N00 (DPA6102)	152
1113336000	–		192	1188845	–	²⁾ K028254N00 (DPA6101)	152
1121440000	–	¹⁾ K004231 (KU4124)	67	1188851	–		153
1121441000	–	¹⁾ II17354 (KU1310)	67	1188909	–	¹⁾ AC574AXY	60
1121442000	–	¹⁾ K004230 (KU4128)	67	1188945	–	¹⁾ 274746	191
1121443000	–	¹⁾ II17355 (KU1311)	67	1189067	–	¹⁾ 295517	153
1121530000	–	¹⁾ K004231 (KU4124)	67	1189089	–	¹⁾ II30180 (LA8226)	21
1121531000	–	¹⁾ II17354 (KU1310)	67	1189106	–		15
1121532000	–	¹⁾ K004230 (KU4128)	67	1189107	–		15
1121533000	–	¹⁾ II17355 (KU1311)	67	1189126	–	¹⁾ II30810 (LA8245)	21
1142510000	–	¹⁾ K004231 (KU4124)	67	1189163	–	¹⁾ II30181 (LA8227)	21
1142511000	–	¹⁾ K004230 (KU4128)	67	1189229-01	–		126
1185145	–		33	1189229-04	–	¹⁾	126
1185157	–	²⁾ 272917	153	1189229-05	–	¹⁾	126
1185774	–	¹⁾ II19375 (LA8206)	21	1189239	–	¹⁾ EF141PYX	129
1185782	–	¹⁾ 295476	190	1189393000	–		33
1186540	–	¹⁾ II30448 (LA8234)	21	1189394000	–		33
1186540-1	–	¹⁾ II30810 (LA8245)	21	1189395000	–		33
1186551XU	–	¹⁾ 1194215X50	12	1189396000	–		33
1186591	–	¹⁾ II36935000 (LA6710)	19	1189421SP	MC20		213
1186643	–	¹⁾ 1194221	52	1189471	–	¹⁾ II30182 (LA8224)	21
1186645	–	¹⁾ 1194220000	52	1189483	–		158
1186677	–		52	1189484	–		158
1186699-05	–		126	1189489000	–		33
1186699-06	–	²⁾	126	1189490	–		126
1186715	–	¹⁾ AC574AXY	60	1194016	–		70
1186720	–	²⁾ 1189106	15	1194128	–	¹⁾ II30448 (LA8234)	21
1186721	–	²⁾ 1189107	15	1194130	–		74
1186722SP	–		15	1194135	–	¹⁾ K001126000 (LK4936)	15
1186753XU	–	²⁾ K028253N00 (DPA5001)	152	1194150	–	¹⁾ II30178 (LA8223)	21
1186754XU	–	²⁾ K028254N00 (DPA6101)	152	1194180	–	¹⁾ II30448 (LA8234)	21
1186762	–	¹⁾ 295473	190	1194186	MC18		213
1186765	–	¹⁾ II30448 (LA8234)	21	1194188	–	¹⁾ II30180 (LA8226)	21
1186831	–		70	1194211	–	¹⁾ II30181 (LA8227)	21
1186872	–		158	1194215X50	–		12
1186885-01	–	¹⁾ 1189229-01	126	1194215XU	–	²⁾ 1194215X50	12
1186885-02	–	¹⁾ 1189229-01	126	1194217	–	¹⁾ II30178 (LA8223)	21

Products in Part Number order
Produkte, nach Teilenummern geordnet

Classification des Produits par Numero
Prodotti ordinati per Codice

Part Number	Type Number	Replacement/Remplacé par Ersatz / Sostituito da	Page	Part Number	Type Number	Replacement/Remplacé par Ersatz / Sostituito da	Page
1194220	-	²⁾ 1194220000	52	201.0007	-		226
1194220000	-		52	201.0013	-		225
1194221	-	²⁾	52	201.0013	-		225
1194228	-	¹⁾ II30182 (LA8224)	21	2024GCMSS	-	²⁾ K037983N00 (BX7414)	141
1194233	-	¹⁾ 1194456000	15	205948DK	-		153
1194303	-	¹⁾ 295475	190	217380DB	-	¹⁾ 288323	37
1194309	-	¹⁾ II30180 (LA8226)	21	224417	-	¹⁾ 274997	62
1194339	-		62	2261024304	-	²⁾ II16774	94
1194360	-		158	2264461308	-	²⁾ 205948DK	153
1194361	-		158	2264461308000	-		118
1194362	-		158	2264461310100	-		118
1194363	-		158	2264461324000	-		118
1194379	-		158	2264461327000	-		118
1194390	-		158	2264461331000	-		118
1194403	-	²⁾	52	2264462353000	-		118
1194404	-	²⁾	52	2264462369000	-	²⁾	116
1194406	-	²⁾ K028300N00 (DPA6103)	152	2264462373000	-	²⁾	118
1194415	-	¹⁾ K001126000 (LK4936)	15	2264462397100	-		90, 116
1194421	-	¹⁾ K001127000 (LK4937)	15	2264462398100	-		90, 116
1194456	-	²⁾ 1194456000	15	2264462399	-	²⁾ K022273N00	91
1194456000	-		15	2264462400	-	²⁾ K022274N00	91
1194487	-	¹⁾ K002120000 (LK4952)	15	2267200314	-	¹⁾ II36381 (EZ1022)	94
1194511SP	-		116	2267200318	-	¹⁾ II36381 (EZ1022)	94
1252012010	-	¹⁾ SEB01315	153	226908	-	²⁾ 226908N	29
1252013010	-	¹⁾ SEB01316	153	226908N	-		29
131.776	T4300-I	²⁾	160	228078	-		37
131.777	T4300-D	²⁾	160	228600DK	-	¹⁾ 274746	191
131.790	T3700-I	²⁾ K016152 (T3700-I)	160	228691	-	¹⁾ 274999	62
131.791	T3700-D	²⁾ K016153 (T3700-D)	160	229813	-	²⁾ 229813N	62
1407023	SF3	²⁾ 1407023C (SF3)	208	229813N	-		62
1407023C	SF3		208	229813R	-	²⁾ 229813N	62
1409284	SF17	²⁾ 1409284C (SF17)	208	240.0162	-		226
1409284C	SF17		208	2424GCMLS	-	²⁾ K038537N00 (BX7545)	141
1409285	SF18	²⁾ 1409285C (SF18)	208	2430GCMEXLS	-	²⁾ K037810N00 (BX7542)	141
1409285C	SF18		208	2430GCMLS	-	²⁾ K038535N00 (BX7543)	141
1422762	SF42	²⁾ 1422762C (SF42)	208	256.0035	-		226
1422762C	SF42		208	267026	-		158
1487434015	-	¹⁾ II40100F	30	267027	-		158
1487434016	-	¹⁾ II40100F	30	267037	-		190
1487434901	-	¹⁾ II40100F	30	267083	-		158
1487434903	-	¹⁾ II38749F004 (AE4529)	40	267084	-		158
1497434100	-	¹⁾ II40100F	30	267086	-		153
1497434102	-	¹⁾ II40100F	30	267098	-		33
1497434103	-	¹⁾ II40100F	30	267114	-		60
1497434301	-	¹⁾ II40100F	30	269700	-		153
1497434303	-	¹⁾ II40100F	30	269799	-	¹⁾ 274746	191
1507434000000	-		30	272295	-		190
200.0179	-		226	272827	-	¹⁾ 274746	191

Products in Part Number order
Produkte, nach Teilenummern geordnet

Classification des Produits par Numero
Prodotti ordinati per Codice

Part Number	Type Number	Replacement/Remplacé par Ersatz / Sostituito da	Page	Part Number	Type Number	Replacement/Remplacé par Ersatz / Sostituito da	Page
272862	–		158	295036N	–		71
272863	–		158	295071	–		60
272917	–		153	295078	–	¹⁾ KX2068/5	31
273673	–	¹⁾ 277516	75	295199	–		60
274520	–		153	295295	–		60
274602	–	¹⁾ 274746	191	295305	–	¹⁾ 295295	60
274657	–		158	295312	–	¹⁾ 277516	75
274746	–		191	295334	–		158
274780	–	¹⁾ 295473	190	295341	–	¹⁾ 274746	191
274781	–	¹⁾ 295476	190	295358	–		71
274836	–	¹⁾ 277516	75	295397	–	¹⁾ 277148DK	37
274869	–	¹⁾ 277971DK	37	295473	–		190
274996	–		62	295475	–		190
274997	–		62	295476	–		190
274999	–		62	295477	–	¹⁾ 295473	190
275491DK	–		33	295481	–	¹⁾ 295473	190
275508DK	–		33	295482	–	¹⁾ 295476	190
277144DK	–		43	295492	–	¹⁾ KX2068/2	31
277147DK	–		37	295517	–		153
277148DK	–		37	295518	–		153
277226	–	²⁾ 277147DK	37	295522	–	¹⁾ KX2068/2	31
277227DK	–		37	295525	–	¹⁾ KX2045/11000	43
277486DK	–		33	295528	–		60
277516	–	²⁾	75	295528000	–	²⁾ 295528	60
277971DK	–	²⁾	37	295529	–	¹⁾ 295295	60
280375DK	–		60	295567	–		158
280707	–	¹⁾ 229813N	62	30010077/A	–		126
280737RM	–	²⁾ 280737X50	15	3001-0077/A	–	¹⁾ 30010077/A	126
280737X50	–		15	3030GCMLS	–	²⁾ K038538N00 (BX7618)	141
280737X57	–	²⁾ 280737X50	15	443612061001	–	¹⁾ I94095 (EE1100)	31
280765	–	¹⁾ 229813N	62	443612061003	–	²⁾ I82646 (EE4107)	31
282133	–	²⁾ 277148DK	37	443612074703	–	²⁾ K000055 (AE4463)	40
283321	–	²⁾	71	443612407002	–	¹⁾ I137167 (BR5658)	58
284727	–	²⁾	75	443612407005	–	¹⁾ I137166 (BR5657)	58
285529	–	¹⁾ 285849	192	5004228	–	¹⁾ I137986	183
285531	–	¹⁾ 229813N	62	5011450	–	¹⁾ 289714	62
285849	–	²⁾	192	5014123	–	¹⁾ AC597A	64
286104RM	–	²⁾ 286104X50	15	530003	–	¹⁾ KW3405/1	228
286104X50	–		15	530090	–	¹⁾ 1185145	33
286968X50	–		30	541L9101	–		75
286968XU	–	²⁾ 286968X50	30	622107AM	–		211
287416	–	²⁾	191	622108AM	–	¹⁾ 622199AM	211
288323	–	²⁾	37	622109AM	–		211
288417	–	²⁾ 288417N	63	622190AM	–		211
288417N	–		63	622199AM	–		211
288417R	–	²⁾ 288417N	63	622206AM	–	¹⁾ 626162AM	211
289714	–	²⁾	62	622402AM	–	¹⁾ 625586AM	211
295036	–	²⁾ 295036N	71	622502AM	–		211

Products in Part Number order
Produkte, nach Teilenummern geordnet

Classification des Produits par Numero
Prodotti ordinati per Codice

Part Number	Type Number	Replacement/Remplacé par Ersatz / Sostituito da	Page	Part Number	Type Number	Replacement/Remplacé par Ersatz / Sostituito da	Page
622508AM	-	¹⁾ 628450AM	211	627052AM	-	²⁾ 630361AM	211
623104AM	-		214	627494AM	-		221
623105AM	-		214	627496AM	-		220
623106AM	-		214	627497AM	-		211
623109AM	-		214	627498AM	-		211
623160AM	-		214	627499AM	-		211
623172AM	-	¹⁾ 626761AM	214	627612AM	-		211
624199AM	-		211	627692AM	-	²⁾ 629683AM	211
624445AM	-	¹⁾ 627612AM	211	628027AM	-		211
624503AM	-		214	628036AM	-		211
624652AM	-	¹⁾ 627498AM	211	628258AM	-		211
624692AM	-	¹⁾ 626760AM	214	628259AM	-		211
625290AM	-		211	628260AM	-		211
625291AM	-	¹⁾ 628450AM	211	628275AM	-		211
625359AM	-	¹⁾ 627692AM	211	628276AM	-		211
625375AM	-		211	628277AM	-		211
625385AM	-	¹⁾ 626162AM	211	628448AM	-		211
625436AM	-	²⁾ 628027AM	211	628450AM	-		211
625524AM	-		211	628492AM	-	²⁾ 629276AM	211
625536AM	-		214	628493AM	-	²⁾ 629277AM	211
625586AM	-		211	628494AM	-		211
625597AM	-	¹⁾ 627499AM	211	629276AM	-		211
625826AM	-		214	629277AM	-		211
625862AM	-		211	629298AM	-		214
626104AM	-	¹⁾ 627497AM	211	629300AM	-		211
626159AM	-		214	629479AM	-		211
626162AM	-		211	629614AM	-		221
626196AM	-	²⁾ 625536AM	214	629683AM	-		211
626298AM	-	¹⁾ 626565AM	214	630361AM	-		211
626321AM	-		220	630388AM	-		220
626392AM	-		211	758188.01SP	MC19		213
626393AM	-	¹⁾ 626392AM	211	AC135AYZ	-	²⁾ 0481039219000	34
626397AM	-	²⁾ 629479AM	211	AC135BXZ	-	²⁾ 0481039218000	34
626565AM	-		214	AC135BZ	-	²⁾ 0481039266000	34
626580AM	-	¹⁾ 628275AM	211	AC135HYZ	-	²⁾ 0481042225000	34
626597AM	-		221	AC150C	-	¹⁾ AC156C	43
626639AM	-		211	AC152AA	-		43
626662AM	-		220	AC152DA	-		43
626693AM	-		211	AC152LA	-		43
626708AM	-	¹⁾ 628277AM	211	AC155A	-		43
626760AM	-		214	AC155B	-		43
626761AM	-		214	AC155D	-		43
626762AM	-		214	AC155E	-		43
626783AM	-	¹⁾ 628450AM	211	AC155F	-		43
626784AM	-	²⁾ 628275AM	211	AC156C	-		43
626785AM	-	²⁾ 628276AM	211	AC156D	-		43
626786AM	-	²⁾ 628277AM	211	AC157A	-		43
626853AM	-		211	AC157C	-		43

Products in Part Number order
Produkte, nach Teilenummern geordnet

Classification des Produits par Numero
Prodotti ordinati per Codice

Part Number	Type Number	Replacement/Remplacé par Ersatz / Sostituito da	Page	Part Number	Type Number	Replacement/Remplacé par Ersatz / Sostituito da	Page
AC157CA	-		43	AC597C	-		64
AC157E	-		43	AC597D	-		64
AC157G	-		43	AC598A	-		65
AC157L	-		43	AC598B	-		65
AC157M	-		43	AC598BX	-		65
AC157P	-		43	AC598C	-		65
AC285B	-		218	AC599A	-		65
AC286A	-		78	AC784B	-		228
AC375A	-		223	AC951A	-		27
AC398A	-		223	AS3050A	-		68, 108
AC399A	-		223	BFM121BK	-	¹⁾ K003845000 (BY9233)	142
AC399B	-		223	BFM121BXK	-	¹⁾ K003869000 (BY9238)	142
AC474AA	-	²⁾ K004152 (KU4128)	67	BFM121CK	-	²⁾ K003868000 (BY9237)	142
AC475AA	-	¹⁾ K004229 (KU4124)	67	BFM121CXK	-	¹⁾ K003868000 (BY9237)	142
AC476BA	-	²⁾ II17355 (KU1311)	67	BFM121EK	-	¹⁾ K003847000 (BY9235)	142
AC477BA	-	²⁾ II17354 (KU1310)	67	BFM122BK	-	¹⁾ K003865000 (BY9236)	142
AC480B	-		66	BFM161BY	-	¹⁾ K014026000 (BY9305)	143
AC481B	-		66	CP4A	-		75
AC560AA	-		68	CP4C	-		75
AC560BAK	-		68	CP6A	-		49, 50, 75
AC570A	-	¹⁾ 0481026008000	60	CP6B	-		75
AC570D	-	¹⁾ 0481026013000	60	CP6C	-		75
AC570DX	-	²⁾ 0481026302000	60	CP6D	-		75
AC574A	-		60	CP6E	-		75
AC574AK	-		60	DPM28A	-		52
AC574AX	-		60	DPM29A	-		52
AC574AXY	-		60	DPM40CA	-		52
AC574AY	-		60	DPM60EY	-		53
AC574BYW	-		60	DPM61A	-		53
AC574CXY	-		60	DPM61EY	-		53
AC574HXY	-		60	DPM62A	-		53
AC575A	-		60	DPM62BA	-	²⁾	53
AC576AK	-		60	DPM63AX	-		53
AC577A	-		60	DPM64A	-		53
AC577AA	-		60	DPM65A	-		53
AC577B	-		60	DPM66A	-		53
AC579BK	-	²⁾ K008433 (AC579BK)	61	DPM67A	-		53
AC586AAX	-		60	DPM68A	-		53
AC586AY	-		60	DPM80A	-		53
AC595BB	-	²⁾ AC597B	64	DPM80AX	-		53
AC595CC	-	²⁾ AC597C	64	DPM84AX	-		53
AC595FF	-	²⁾ AC597B	64	DPM84CX	-		53
AC596A	-		64	DPM84CY	-		53
AC596B	-		64	DPM90B	-		53
AC597A	-		64	DPM90BK	-		53
AC597B	-		64	DPM90CK	-		53
AC597BA	-		64	DPM90D	-		53
AC597BZ	-		64	DPM90DA	-		53

Products in Part Number order
Produkte, nach Teilenummern geordnet

Classification des Produits par Numero
Prodotti ordinati per Codice

Part Number	Type Number	Replacement/Remplacé par Ersatz / Sostituito da	Page	Part Number	Type Number	Replacement/Remplacé par Ersatz / Sostituito da	Page
DPM90EY	-		53	EF161DY	-		129
DPM92A	-		53	EF161DYX	-		129
DPM92B	-		53	EF161FY	-		129
DPM92BK	-		53	EF161NYX	-		129
DPM92D	-		53	EF161PYX	-		129
DPM93D	-		53	EF180BY	-		129
DPM94AAX	-		53	EF180FY	-		129
DPM94EY	-		53	EF180NYX	-		129
DPM95AAX	-		53	EF180PYX	-		129
DPM95AK	-		53	EF1AK	-		153
DPM96DAX	-		53	EF201BY	-		129
DPM96EY	-		53	EF201LA	-		129
DPM99A	-		53	EF201LY	-		130
DX60A	-		47	EF221LY	-		130
DX61A	-		47	EF241BY	-		130
DX65A	-	¹⁾ DX65B	47, 49, 50	EF241LY	-		130
DX65B	-		47, 49, 50	EF241MY	-		130
DX65BA	-		47, 50	EF241QA	-		130
DX65C	-		47, 49	EF90YE	-		129
DX70C	-		47	EF90YES	-		129
DX71BX	-		47	EK300010000	EK3000	²⁾ I9702110000 (EK3000)	121
DX71BY	-		47	EK30005000	EK3000	²⁾ I970215000 (EK3000)	121
DX75BAY	-		47	EK300110000	EK3001	²⁾ II1563910000 (EK3001)	121
DX75BX	-		47	EK30011200	EK3001		121
DX80D	-		47	EK300112000	EK3001	²⁾ II1563912000 (EK3001)	121
DX80E	-		47	EK30012500	EK3001		121
DX81E	-		47	EK30013000	EK3001	²⁾ II156393000 (EK3001)	121
DX95BX	-		48	EK30013500	EK3001		121
DX95BY	-		48	EK30014000	EK3001		121
DX95F	-		48	EK30014500	EK3001		121
EDP25AA	-		186	EK30015000	EK3001	²⁾ II156395000 (EK3001)	121
EDP25AA/1	-		186	EK30016000	EK3001	²⁾ II156396000 (EK3001)	121
EDP26AA	-		186	EK3001800	EK3001		121
EDP26AA/1	-		186	EK30018000	EK3001	²⁾ II156398000 (EK3001)	121
EDP26AAX	-		186	EK30018500	EK3001		121
EF105BY	-		129	EK301112000	EK3011	²⁾ II1415612000 (EK3011)	119
EF105FY	-		129	EK30113000	EK3011	²⁾ II141563000 (EK3011)	119
EF120BY	-		129	EK30114000	EK3011	²⁾ II141564000 (EK3011)	119
EF120C	-		129	EK30116000	EK3011	²⁾ II141566000 (EK3011)	119
EF120FY	-		129	EK30118000	EK3011	²⁾ II141568000 (EK3011)	119
EF120L	-		129	ETC1AKN50	-		100
EF120P	-		129	GCM1B	-		219
EF120YES	-		129	GCM1C	-		219
EF141AY	-		129	GCM1E	-		219
EF141FY	-		129	I15658	AE4102	²⁾	71
EF141NYX	-		129	I16438	EE1101		31
EF141PYX	-		129	I17154	AE4103		71
EF161AY	-		129	I183843	LP2983	¹⁾ I83843 (LP2983)	15

Products in Part Number order
Produkte, nach Teilenummern geordnet

Classification des Produits par Numero
Prodotti ordinati per Codice

Part Number	Type Number	Replacement/Remplacé par Ersatz / Sostituito da	Page	Part Number	Type Number	Replacement/Remplacé par Ersatz / Sostituito da	Page
I22144	DB1104		44	I69858	DR4342	¹⁾ K000638 (DR4372)	38
I25011A	–		66	I69860	DR4344	²⁾ K000641 (DR4375)	38
I25351	AE5101		70	I69861	DR4345	²⁾ K000643 (DR4377)	38
I27644	MB1200	¹⁾ I72775 (MB1200)	48	I69864	DR4348	²⁾ K000645 (DR4379)	38
I27926	DR4300	¹⁾ K000639 (DR4373)	38	I69866	DR4350	¹⁾ K000636 (DR4370)	38
I27927	DR4301	¹⁾ K000644 (DR4378)	38	I71205	WE2130	¹⁾ I94846 (WE2135)	190
I27929	DR4304	¹⁾ K000641 (DR4375)	38	I71206	WE2131		191
I28847	DR4102	¹⁾ K000618 (DR4155)	37	I71315	DR4331	¹⁾ K000647 (DR4381)	38
I30064	WHV–9		75	I71420	KU4124	²⁾ K004231 (KU4124)	67
I34991	WE2200	¹⁾ I92570 (WE2207)	190	I71421	KU4128	²⁾ K004230 (KU4128)	67
I37739	–		71	I7178304	DMV18		44
I40405	AE4105		71	I7178305	DMV18		44
I41333	SV1219	¹⁾ I136169 (SV1481)	198	I72775	MB1200		48
I41424	DR4309	¹⁾ K000645 (DR4379)	38	I72796	DB2123	¹⁾ I86159 (DB2123)	63
I54395	DR3200	²⁾ 0481039240000	34	I73591	DB1151	¹⁾ I79644 (DB1151)	44
I55133	DR3201	²⁾ 0481039222000 (DR3201)	35	I73682	AE1114		75
I55704	EE1100	¹⁾ I94095 (EE1100)	31	I74435	AE5117	¹⁾ I75598 (AE5115)	70
I55727	MB4512		48	I74772	EE4103		31
I58101	KU4124	¹⁾ K004231 (KU4124)	67	I74907	MB4630		48
I58893	SZ1115		223	I74908	RE2113		62
I59068	KU4128	¹⁾ K004230 (KU4128)	67	I74963	SZ1130	¹⁾ I90948 (SZ1161)	223
I59070	KU1303		66	I75349	DR4128	²⁾ K000616 (DR4153)	37
I59258	KU1304		66	I75356	DR4352	²⁾ K000651 (DR4385)	38
I59259	KU1305	¹⁾ I133263 (KU1305)	67	I75358	DR4354	²⁾ K000647 (DR4381)	38
I60363	AB2761	¹⁾ 0481061005000	64	I75598	AE5115		70
I61241	DB1114		44	I76192	EE4206	¹⁾ I116095 (EE4206)	32
I61423	BZ3324	²⁾ K045254N00 (BZ3324)	126	I76204	RE1115	²⁾ K008490 (AC574AA)	61
I61707	DB1116		44	I76260	BZ3645		136
I61720	HB1143	¹⁾ I82171N00 (HB1143)	54	I76261	BZ3713		136
I61840	RE2221	¹⁾ I63354 (RE2221)	61	I76269	SV1289	¹⁾ K002335 (SV1294)	197
I63354	RE2221		61	I76270	SV1290	¹⁾ K002335 (SV1294)	197
I66920	AE1111		75	I76271	SV1291	¹⁾ K002335 (SV1294)	197
I67812	KU1311	¹⁾ I117355 (KU1311)	67	I76272	SV1292	¹⁾ K002335 (SV1294)	197
I67813	KU1310	¹⁾ I117354 (KU1310)	67	I76274	SV1294	¹⁾ K002335 (SV1294)	197
I67981	SIV-10K		192	I76624	MB4630	¹⁾ I74907 (MB4630)	48
I68649	DR3216	¹⁾ 0481039258000 (DR3232)	35	I76627	RE1115	¹⁾ K008490 (AC574AA)	61
I69421	AE4156	¹⁾ I81272 (AE4185)	40	I76647	SZ1136		223
I69843	DR4122	²⁾ K000618 (DR4155)	37	I76739	AB2783	¹⁾ 0481061219000	64
I69844	DR4123	²⁾ K000615 (DR4151)	37	I76752	KU1310	¹⁾ I117354 (KU1310)	67
I69846	DR4125	²⁾ K000613 (DR4150)	37	I76753	KU1311	¹⁾ I117355 (KU1311)	67
I69847	DR4126	²⁾ K000619 (DR4156)	37	I76792	RE1110		61
I69848	DR4230	²⁾ K000627 (DR4253)	38	I76938	RE2223	¹⁾ I63354 (RE2221)	61
I69849	DR4231	¹⁾ K014658 (DR4263)	38	I77243	AE4170		40
I69850	DR4232	²⁾ K000630 (DR4256)	38	I77418	AB2778	²⁾ 0481061005000	64
I69853	DR4235	²⁾ K000634 (DR4260)	38	I77420	AB2767	¹⁾ 0481061020000	64
I69854	DR4236	¹⁾ K000624 (DR4250)	38	I77535	LP3832	¹⁾ SEB01151 (LP3860)	13
I69856	DR4340	²⁾ K000639 (DR4373)	38	I77618	AB2795	²⁾ 0481061214000	64
I69857	DR4341	²⁾ K000644 (DR4378)	38	I78042	BZ3117		130

Products in Part Number order
Produkte, nach Teilenummern geordnet

Classification des Produits par Numero
Prodotti ordinati per Codice

Part Number	Type Number	Replacement/Remplacé par Ersatz / Sostituito da	Page	Part Number	Type Number	Replacement/Remplacé par Ersatz / Sostituito da	Page
I78074	ZB3150		188	I85193	HB1242		54
I78418	SV1303	¹⁾ II32763 (SV1303)	197	I85512	AE4162	²⁾	40
I78861	DR3238	¹⁾ 0481039240000	34	I85564	SZ1159		223
I79002	–		72	I85893	EE1106		31
I79054	SV1304	¹⁾ I85919 (SV1304)	197	I85919	SV1304		197
I79056	AB2783	¹⁾ 0481061219000	64	I86030	SV1328	¹⁾ II32765 (SV1328)	197
I79644	DB1151		44	I86154	DB2115		63
I80091	SV1294		197	I86156	DB2118		63
I80267	BZ7420	¹⁾ II37274 (BX9400)	139	I86159	DB2123		63
I80275	AB2793	¹⁾ 0481061220000	64	I86164	LK1311		12
I80864	LK1802		12	I86233	KU4128	¹⁾ K004230 (KU4128)	67
I81272	AE4185		40	I86291	BY3303		130
I82038	BY3251	¹⁾ 0482023504000	131	I86321	BY7151	¹⁾ II18526000 (BY9154)	144
I82046	BY7151	¹⁾ II18526000 (BY9154)	144	I86322	BY7152	¹⁾ II18525000 (BY9153)	144
I82047	BY7203	¹⁾ II16575000 (BY9200)	144	I86323	BY7203	¹⁾ II16575000 (BY9200)	144
I82111	MB4436		48	I86324	BY7214	¹⁾ II16576000 (BY9201)	144
I82171	HB1143	²⁾ I82171N00 (HB1143)	54	I86378	BY3251	¹⁾ 0482023504000	131
I82171N00	HB1143		54	I86647	LA6205	¹⁾ II30443N00 (LA8229)	21
I82177	HB1350		54	I87101	LA6209	¹⁾ II30447 (LA8233)	21
I82259	AE5115	²⁾ I75598 (AE5115)	70	I87236	SZ1152		223
I82291	LA4115		26	I874851	–		48
I82293	LA4117		26	I87501	LA6210		19
I82304	DR3416	¹⁾ 0481042208000	34	I87544	LK1314		12
I82454	BZ6427		140	I87674	AB2816	¹⁾ 0481061230000	64
I82495	DR3200	²⁾ 0481039240000	34	I87819	VG8125		209
I82646	EE4107		31	I88182	LA6212	¹⁾ I92013 (LA6221)	19
I82697000	RE2117	²⁾	62	I88263	BZ5410		136
I82708	DR3503	¹⁾ 0481039213000 (DR3503)	35	I88478	EE4113	¹⁾ I74772 (EE4103)	31
I82813	DR3510	¹⁾ 0481039235000 (DR3510)	35	I88579	SV1351	²⁾ K002334 (SV1351)	197
I82919	AB2797	¹⁾ 0481061220000	64	I88637	BY7115	¹⁾ II18524000 (BY9104)	144
I83151	SZ1145		223	I88827	BZ3253		130
I83347	AB2798	¹⁾ 0481061226000	64	I89256	LA6250	¹⁾ II31112 (LA8250)	21
I83737	BY7109	¹⁾ II18523000 (BY9103)	144	I89258	LA6252	¹⁾ II30179 (LA8225)	21
I83738	BY7152	¹⁾ II18525000 (BY9153)	144	I89259	LA6253	¹⁾ II30185 (LA8228)	21
I83739	BY7214	¹⁾ II16576000 (BY9201)	144	I89326	LA6215	²⁾ II30650N00 (LA8242)	21
I83747	DB1143		44	I89408	AE4405	²⁾ I89408000 (AE4405)	40
I83843	LP2983		15	I89408000	AE4405		40
I84038	LK1309	¹⁾ I87544 (LK1314)	12	I89742	MB4747		48
I84406	DR5117		192	I89776	LA6217	¹⁾ II30810 (LA8245)	21
I84414	DR5118		192	I90186	LA4127		26
I84433	MB4644	¹⁾ 0481064103000	47	I90309	DR3500	²⁾ 0481039201000 (DR3500)	35
I84794	KU1310	¹⁾ II17354 (KU1310)	67	I90311	DR3502	²⁾ 0481039209000 (DR3502)	35
I84795	KU1311	¹⁾ II17355 (KU1311)	67	I90312	DR3503	¹⁾ 0481039213000 (DR3503)	35
I84808	SV1323	¹⁾ II32764 (SV1323)	197	I90314	DR3531	¹⁾ 0481039241000	34
I84828	LA4127	¹⁾ I90186 (LA4127)	26	I90375	LA4116		26
I84866	EE4104		31	I90499	LP4813	²⁾ I90499000 (LP4813)	16
I84927	DB1159		44	I90499000	LP4813		16
I85133	LA6200	¹⁾ II30185 (LA8228)	21	I90499V	LP4813	²⁾ I90499000 (LP4813)	16

Products in Part Number order
Produkte, nach Teilenummern geordnet

Classification des Produits par Numero
Prodotti ordinati per Codice

Part Number	Type Number	Replacement/Remplacé par Ersatz / Sostituito da	Page	Part Number	Type Number	Replacement/Remplacé par Ersatz / Sostituito da	Page
I90521	LK3921	²⁾ K015518 (LP8701)	13	I9770410000	EK3015		119
I90845	BZ7564	¹⁾ II14008 (BZ7564)	139	I977045000	EK3015		119
I90846	BZ7567	¹⁾ II14009 (BZ7567)	139	I97953	DB1147		44
I90912	BZ7570	¹⁾ II17479 (BZ9506)	139	I98189	LA6735	²⁾ K025606 (LA8704)	22
I90948	SZ1161		223	I98290	SV1411		197
I92013	LA6221		19	I98292	SV1412	²⁾ K000073 (SV1412)	197
I92030	HB1258		54	I98498	LK1545		12
I92054	EE4115		32	I98746	HB1267		54
I92081	LA6222	²⁾ II31475 (LA8254)	21	I98796	BY3156	¹⁾ EF105BY	129
I92200	RE2118		62	I98802	BY3404	¹⁾ EF201LY	130
I92485	DR3541	¹⁾ 0481039235000 (DR3510)	35	I98806	BY3454	¹⁾ EF221LY	130
I92489	VG3213		208	I98810	BY3505	¹⁾ EF241LY	130
I92570	WE2207		190	I98916	LA4129		26
I92972	LK1534		12	I98919	LA6248	¹⁾ II19375 (LA8206)	21
I92999	ZB3163		188	I99632	BR4440	²⁾ II36826 (BR4465)	57
I929991	ZB3163		188	I99660	LA2103		29
I93219	AE4254		71	I99719	MB4690	¹⁾ II36174000 (MB4849)	48
I93262	AB2835	¹⁾ 0481061219000	64	I99810	AE4162		40
I93544	AE9125	¹⁾ II32611 (EA1152)	186	I99812	DR5125		192
I94064	LK3927		12	I99961	AE2109		75
I94095	EE1100		31	IB20BA	–		190
I94158	DR5122		192	IB20CA	–		190
I94299	BR5407	²⁾	58	IB20DA	–		190
I94326	SZ1166		223	IB20EA	–		190
I94622	SV1399	¹⁾ II30525000 (SV1399)	197	IB8D	–		190
I94650	LA4135		26	IB9CY	–		190
I94846	WE2135		190	II36055	–	¹⁾ II36055 (AE4264)	78
I97002	–	¹⁾ II16774	94	II14008	BZ7564		139
I97021/10000	EK3000	¹⁾ I9702110000 (EK3000)	121	II14009	BZ7567		139
I97021/12000	EK3000	¹⁾ I9702112000 (EK3000)	121	II14119	MB4694		48
I97021/5000	EK3000	¹⁾ I970215000 (EK3000)	121	II14130	DR3510	¹⁾ 0481039235000 (DR3510)	35
I97021/8000	EK3000	¹⁾ I970218000 (EK3000)	121	II14156/6000	EK3011	¹⁾ II141566000 (EK3011)	119
I9702110000	EK3000		121	II1415612000	EK3011		119
I9702112000	EK3000		121	II141563000	EK3011		119
I9702115000	EK3000		121	II141564000	EK3011		119
I970215000	EK3000		121	II141566000	EK3011		119
I970218000	EK3000		121	II141568000	EK3011		119
I97142	VG3221	²⁾ K002173 (VG3286)	209	II14535	BS3300		133
I97255/12000	EK3010	¹⁾ I9725512000 (EK3010)	119	II14535000	BS3300	²⁾ II14535 (BS3300)	133
I97255/3000	EK3010	¹⁾ I972553000 (EK3010)	119	II14540	BS3450		134
I9725512000	EK3010		119	II14557	BZ9401	¹⁾ II37274 (BX9400)	139
I972553000	EK3010		119	II14559	BZ9403	¹⁾ II37274 (BX9400)	139
I972559000	EK3010		119	II14560	BZ9425	²⁾ II14560000 (BZ9425)	139
I97326	AB2808	¹⁾ 0481061005000	64	II14560000	BZ9425		139
I97492	LP4814	²⁾ I97492000 (LP4814)	16	II14570	LK1813	¹⁾ II18355 (LK1813)	12
I97492000	LP4814		16	II14588	BR5615		58
I97493	LP4815	²⁾ I97493000 (LP4815)	16	II14781	LK3935	¹⁾ II19494 (LK3935)	12
I97493000	LP4815		16	II14936	WE2137		190

Products in Part Number order
Produkte, nach Teilenummern geordnet

Classification des Produits par Numero
Prodotti ordinati per Codice

Part Number	Type Number	Replacement/Remplacé par Ersatz / Sostituito da	Page	Part Number	Type Number	Replacement/Remplacé par Ersatz / Sostituito da	Page
II15224	BZ9408	²⁾ II37274 (BX9400)	139	II16852	BZ9406		139
II15229	BS3350		133	II16854	BZ9404	²⁾ II37274 (BX9400)	139
II15229000	BS3350	²⁾ II15229 (BS3350)	133	II16854000	BZ9404		139
II15235	SB7005	¹⁾ II37791 (SB7789)	165	II16854R	BZ9404	²⁾ II37274 (BX9400)	139
II15334	AB2851	¹⁾ II37151 (AB2851)	65	II16855	BZ9405	²⁾ II16855000 (BZ9405)	139
II15372	BR4441	²⁾ II15372000 (BR4441)	57	II16855000	BZ9405		139
II15372000	BR4441		57	II16855R	BZ9405	²⁾ II37274 (BX9400)	139
II15492	BR9150	²⁾ K015676N00	83	II17092	BZ9502		139
II15498	SB7015	¹⁾ II37792 (SB7799)	165	II17281	SB7505	¹⁾ II37791 (SB7789)	165
II15587	AE4427	²⁾ II15587000 (AE4427)	40	II17282	SB7515	¹⁾ II37792 (SB7799)	165
II15587000	AE4427		40	II17352	BR4452	²⁾ II36828 (BR4467)	57
II15588	AE4428	²⁾ II15588000 (AE4428)	40	II17354	KU1310		67
II15588000	AE4428		40	II17355	KU1311		67
II15615	-	²⁾	17	II17366	LA9000	¹⁾ K024634N00 (LA9034)	22, 24
II15616	-	²⁾	17	II17369	LA9001	¹⁾ K024634N00 (LA9034)	22, 24
II15639/10000	EK3001	¹⁾ II1563910000 (EK3001)	121	II17393	LK1560		12
II15639/8000	EK3001	¹⁾ II156398000 (EK3001)	121	II17395	LP4957	¹⁾ K002975000 (LP4957)	16
II1563910000	EK3001		121	II17468	BY9205		142
II1563912000	EK3001		121	II17479	BZ9506		139
II156393000	EK3001		121	II17755	BY9451		143
II156395000	EK3001		121	II17756	BY9501		143
II156396000	EK3001		121	II17770M1	-	¹⁾ K000511 (VG3284)	209
II156398000	EK3001		121	II17771	VG3364		209
II15687	BR9151	²⁾ K015677N00	83	II17776N00	BR9154		83
II15687R	BR9151	²⁾ K015677N00	83	II17793	-	²⁾ II40100F	30
II15697	LP4823	¹⁾ SEB01782000 (LP4823)	16	II17935	SB7521	¹⁾ II36490 (SB7989)	163
II15697M1	LP4823	¹⁾ SEB01782000 (LP4823)	16	II17936	SB7531	¹⁾ II36491 (SB7999)	163
II15698	LP4930	¹⁾ K000236000 (LP4974)	16	II17937	SB7522	¹⁾ II36490 (SB7989)	163
II15992000	LP4934	²⁾ II30895 (LP4934)	16	II17938	SB7532	¹⁾ II36491 (SB7999)	163
II15993	LP4825	²⁾ II15993000 (LP4825)	16	II18224	BS9398		148
II15993000	LP4825		16	II18355	LK1813		12
II16060	SB7022	¹⁾ II36490 (SB7989)	163	II18503	SV1323	¹⁾ II32764 (SV1323)	197
II16070	SB7032	¹⁾ II36491 (SB7999)	163	II18523	BY9103	²⁾ II18523000 (BY9103)	144
II16095	EE4206		32	II18523000	BY9103		144
II16096	EE4106		31	II18524	BY9104	²⁾ II18524000 (BY9104)	144
II16189	SV1425		197	II18524000	BY9104		144
II16229	BS3350	¹⁾ II15229 (BS3350)	133	II18525	BY9153	²⁾ II18525000 (BY9153)	144
II16278	BR9152	²⁾ K015677N00	83	II18525000	BY9153		144
II16361	MB1226		48	II18526	BY9154	²⁾ II18526000 (BY9154)	144
II16404	-	¹⁾ II37415	183	II18526000	BY9154		144
II16404EVO	-	²⁾	183	II18599	LP4830	¹⁾ SEB01781 (LP4830)	16
II16468	RE1141		61	II18691	BY9504		143
II16575	BY9200	²⁾ II16575000 (BY9200)	144	II18692	BY9452		143
II16575000	BY9200		144	II18784	BR4455		57
II16576	BY9201	²⁾ II16576000 (BY9201)	144	II18785	BR4456		57
II16576000	BY9201		144	II18786	BR4457		57
II16774	-		94	II18822	-	¹⁾ II37191	183
II16784	DR4248	¹⁾ K000626 (DR4252)	38	II18850	BS3451		134

Products in Part Number order
Produkte, nach Teilenummern geordnet

Classification des Produits par Numero
Prodotti ordinati per Codice

Part Number	Type Number	Replacement/Remplacé par Ersatz / Sostituito da	Page	Part Number	Type Number	Replacement/Remplacé par Ersatz / Sostituito da	Page
II18886	BS3452		134	II19451	SB7564	¹⁾	162
II18923	SB7040	¹⁾ II36490 (SB7989)	163	II19452	SB7574	¹⁾ II37792 (SB7799)	165
II18924	SB7050	¹⁾ II36491 (SB7999)	163	II19453	SB6500	¹⁾	162
II18925	SB7541	¹⁾ II36490 (SB7989)	163	II19483	LA8219	²⁾ II19483N00 (LA8219)	21
II18926	SB7551	¹⁾ II36491 (SB7999)	163	II19483N00	LA8219		21
II18927	SB7540	¹⁾ II36490 (SB7989)	163	II19484	LA8220	²⁾ II19484N00 (LA8220)	21
II18928	SB7550	¹⁾ II36491 (SB7999)	163	II19484N00	LA8220		21
II18971	BZ9553	²⁾ II18971000 (BZ9553)	139	II19485	LA8221	²⁾ II19485N00 (LA8221)	21
II18971000	BZ9553		139	II19485N00	LA8221		21
II18972	BZ9554	²⁾ II18972000 (BZ9554)	139	II19486	LA8222	²⁾ II19486N00 (LA8222)	21
II18972000	BZ9554		139	II19486N00	LA8222		21
II19019	BS3507	²⁾ K015585 (BS3507)	134	II19494	LK3935		12
II19020	BZ9510	²⁾ II19020000 (BZ9510)	139	II19495	LK3955	²⁾ II19494 (LK3935)	12
II19020000	BZ9510		139	II19612	VG3238		208
II19088	MB4813	¹⁾ II36364 (MB4813)	48	II19707	SB7624	¹⁾ II37791 (SB7789)	165
II19090	MB4815	²⁾ II36302 (MB4815)	48	II19708	SB7634	¹⁾ II37792 (SB7799)	165
II19204	LA8207		21	II19723	SB7580	¹⁾ II34324 (SB7711)	162
II19205	LA8208		21	II19724	SB7590	¹⁾ II34323 (SB7701)	162
II19206	LA8209		21	II19725	SB7580	¹⁾ II34326 (SB7712)	163
II19207	LA8210		21	II19726	SB7590	¹⁾ II34325 (SB7702)	163
II19208	LA8211		21	II19748	BZ9630		139
II19209	LA8212		21	II19750	BY9260		142
II19216	LA8205		21	II19770	–	²⁾ II40100F	30
II19252	–	²⁾ II37951004EN	232	II19802	AE4262		78
II19253	–	²⁾ II37951004EN	232	II19803	AE4261		78
II19264	BZ9512		139	II30079	BZ9529		139
II19265	BZ9513		139	II30175	SB7588	¹⁾ II34456 (SB7705)	163
II19266	BZ9514		139	II30178	LA8223		21
II19330	LA6268	¹⁾ II19216 (LA8205)	21	II30179	LA8225		21
II19332	LA8001	²⁾ II19332N00 (LA8001)	19	II30180	LA8226		21
II19332N00	LA8001		19	II30181	LA8227		21
II19333	LA8002	²⁾ II19333N00 (LA8002)	19	II30182	LA8224		21
II19333N00	LA8002		19	II30185	LA8228		21
II19334	LA8003	²⁾ II19334N00 (LA8003)	19	II30212	BZ9418	²⁾ II37274 (BX9400)	139
II19334N00	LA8003		19	II30223	ES1080	²⁾	82
II19335	LA8004	²⁾ II19335N00 (LA8004)	19	II30267	DR4341	²⁾ K000644 (DR4378)	38
II19335N00	LA8004		19	II30393	BY9263	²⁾ II30393000 (BY9263)	144
II19337	LA8006	²⁾ II19337N00 (LA8006)	19	II30393000	BY9263		144
II19337N00	LA8006		19	II30400	SB7598	¹⁾ II34457 (SB7715)	163
II19338	LA8007	²⁾	19	II30401	SB7589	¹⁾ II36490 (SB7989)	163
II19342	BZ9417	²⁾ II19342000 (BZ9417)	139	II30402	SB7599	¹⁾ II36491 (SB7999)	163
II19342000	BZ9417		139	II30418	–	¹⁾ K005594	184
II19362	LA8008	²⁾ II19362N00 (LA8008)	19	II30419	–		183
II19362N00	LA8008		19	II30443	LA8229	²⁾ II30443N00 (LA8229)	21
II19367	LA8013	²⁾ II19335N00 (LA8004)	19	II30443N00	LA8229		21
II19369	LA8015	²⁾ II19369N00 (LA8015)	19	II30444	LA8230		21
II19369N00	LA8015		19	II30447	LA8233		21
II19375	LA8206		21	II30448	LA8234		21

Products in Part Number order
Produkte, nach Teilenummern geordnet

Classification des Produits par Numero
Prodotti ordinati per Codice

Part Number	Type Number	Replacement/Remplacé par Ersatz / Sostituito da	Page	Part Number	Type Number	Replacement/Remplacé par Ersatz / Sostituito da	Page
II30449	LA8235	²⁾ II30444 (LA8230)	21	II31407000	BS9404		148
II30455	LA8027		19	II31409	BX9500		139
II30458	LA8028		19	II31475	LA8254		21
II30499	LA8235	¹⁾ II30444 (LA8230)	21	II31480	AE4452	²⁾ II31480000 (AE4452)	40
II30522	BR9231		92	II31480000	AE4452		40
II30525	SV1399	²⁾ II30525000 (SV1399)	197	II31481	LA8259		21
II30525000	SV1399		197	II31482	–	²⁾ II40100F	30
II30527	AE1136		75	II31782	BS3251		133
II30614000	BS3301	²⁾ K004146N00 (BS3301)	133	II31782000	BS3251	¹⁾ II31782 (BS3251)	133
II30616	BS3402	²⁾ K005086 (BS3402)	133	II31783	BS9297		148
II30617	BS3403	²⁾ K005087 (BS3403)	133	II31783000	BS9297	²⁾ II31783 (BS9297)	148
II30650	LA8242	²⁾ II30650N00 (LA8242)	21	II31877	LA8032		19
II30650N00	LA8242		21	II31951	LK3927	²⁾ I94064 (LK3927)	12
II30657	LA8239		21	II31984	SB7102	¹⁾	162
II30676	–	¹⁾ Z002016	184	II31984AT	–	¹⁾	162
II30677	–	¹⁾ Z002017	184	II31984M2	SB7102	¹⁾ II31984 (SB7102)	162
II30692	SB6502	¹⁾	162	II31985	SB7112	¹⁾	162
II30693	SB6512	¹⁾	162	II31985AT	–	¹⁾	162
II30810	LA8245		21	II31985M2	SB7112	¹⁾ II31985 (SB7112)	162
II30848	MB4820	²⁾ II36300 (MB4820)	48	II31997	BZ9317		139
II30849	MB4821	¹⁾ II36299 (MB4821)	48	II32006	BZ9424		139
II30895	LP4934		16	II32124	BZ9442	²⁾ II37274 (BX9400)	139
II30900	LP4961		16	II32128	BZ9646		139
II31017	SB6503	¹⁾	162	II32135	BY9408		143
II31017AT	–	¹⁾	162	II32159	BS9395	²⁾ K007646 (BS9395)	148
II31017M1	SB6503	¹⁾	162	II32160	BS9396	¹⁾ K007647 (BS9396)	148
II31018	SB6513	¹⁾	162	II32161000	BS9507	²⁾ K004046N00 (BS9507)	149
II31018AT	–	¹⁾	162	II32172	BS3522	²⁾ K005212 (BS3522)	134
II31018M1	SB6513	¹⁾	162	II32172N00	BS3522	²⁾ K002722N00 (BS3522)	134
II31019	–	¹⁾ II38335F	183	II32173N00	BS9508	²⁾ K004051000 (BS9508)	149
II31022	SB7041	¹⁾	162	II32174000	BS9509	²⁾ K004053000 (BS9509)	149
II31023	SB7051	¹⁾	162	II32175000	BS9311	²⁾ K002858N00 (BS9311)	148
II31025	–	¹⁾ II37191	183	II32203	SB7681	¹⁾	162
II31026	SB7629	¹⁾ II36490 (SB7989)	163	II32203AT	–	¹⁾	162
II31027	SB7639	¹⁾ II36491 (SB7999)	163	II32204	SB7691	¹⁾	162
II31030	SB7640	¹⁾ II37791 (SB7789)	165	II32204AT	–	¹⁾	162
II31031	SB7650	¹⁾ II37792 (SB7799)	165	II32223	LK3966		13
II31091	BZ9644		139	II32224	LK3515		12
II31098	BS3404		133	II32590	BS9253	¹⁾ K004017N00 (BS9253)	147
II31098000	BS3404	²⁾ II31098 (BS3404)	133	II32597N00	BS3514	²⁾ K002624N00 (BS3514)	134
II31099	BS3453		134	II32598N00	BS3515	²⁾ K002720N00 (BS3515)	134
II31104	BZ9645		139	II32599	BS3516	²⁾ K005211 (BS3516)	134
II31105	BS3511	²⁾ K015586 (BS3511)	134	II32599N00	BS3516	²⁾ K002721N00 (BS3516)	134
II31112	LA8250		21	II32600	BS9305	²⁾ K002855N00 (BS9305)	148
II31119	LA8253		21	II32601	BS9306	²⁾ K002854N00 (BS9306)	148
II31227	BS9397		148	II32604	BS9405	²⁾ K004033N00 (BS9405)	148
II31227000	BS9397	¹⁾ II31227 (BS9397)	148	II32605	BS9406	²⁾ K004034N00 (BS9406)	148
II31407	BS9404	²⁾ II31407000 (BS9404)	148	II32608	BS9500	¹⁾ K004050000 (BS9500)	149

Products in Part Number order
Produkte, nach Teilenummern geordnet

Classification des Produits par Numero
Prodotti ordinati per Codice

Part Number	Type Number	Replacement/Remplacé par Ersatz / Sostituito da	Page	Part Number	Type Number	Replacement/Remplacé par Ersatz / Sostituito da	Page
II32609	BS9504	²⁾ II32609000 (BS9504)	149	II32935	SB7586	¹⁾ II33432 (SB7586)	162
II32609000	BS9504		149	II32936	SB7596	¹⁾ II33433 (SB7596)	162
II32611	EA1152		186	II32941	SB7661	¹⁾ II35957 (SB7729)	163
II32612	BR9156	²⁾ II17776N00 (BR9154)	83	II32942	SB7671	¹⁾ II35958 (SB7739)	163
II32687	LP4964	¹⁾ K002046000 (LP4964)	16	II32963000	BS3250	²⁾ K003968N00 (BS3250)	133
II32688	LP4965	¹⁾ K016615000 (LK4941)	15	II32981AT	–	¹⁾ II33981AT	162
II32697	BS9505	²⁾ II32697000 (BS9505)	149	II32982AT	–	¹⁾ II33982AT	162
II32697000	BS9505		149	II33062000	BS9514	²⁾ K004047N00 (BS9514)	149
II32700	BS9308	²⁾ K002859N00 (BS9308)	148	II33163	LK3965		13
II32701	BS9411	¹⁾ K002861N00 (BS9411)	148	II33164	LP4967	²⁾ II33164000 (LP4967)	16
II32702	BS9412	¹⁾ K002860N00 (BS9412)	148	II33164000	LP4967		16
II32703	BS9502	²⁾ K004052N00 (BS9502)	149	II33164V	LP4967	²⁾ II33164000 (LP4967)	16
II32710	BS3415		133	II33261	AE2110		75
II32723	BS3526	²⁾ K015591 (BS3526)	134	II33262	KU1304		66
II32763	SV1303		197	II33263	KU1305		67
II32764	SV1323		197	II33420	SB7665	¹⁾	162
II32765	SV1328		197	II33421	SB7675	¹⁾	162
II32789	SV1443	²⁾ II36115 (SV1466)	197	II33428	SB6508	¹⁾	162
II32798	SB7648	¹⁾	162	II33429	SB6518	¹⁾	162
II32798AT	–	¹⁾	162	II33430	SB7666	¹⁾	162
II32799	SB7658	¹⁾	162	II33430AT	–	¹⁾	162
II32799AT	–	¹⁾	162	II33430M1	SB7666	¹⁾ II33430 (SB7666)	162
II32799M1	SB7658	¹⁾ II32799 (SB7658)	162	II33431	SB7676	¹⁾	162
II32800	SB7649	¹⁾	162	II33431AT	–	¹⁾	162
II32800AT	–	¹⁾	162	II33431M1	SB7676	¹⁾ II33431 (SB7676)	162
II32800M1	SB7649	¹⁾ II32800 (SB7649)	162	II33432	SB7586	¹⁾	162
II32801	SB7659	¹⁾	162	II33432AT	–	¹⁾	162
II32801AT	–	¹⁾	162	II33432M1	SB7586	¹⁾ II33432 (SB7586)	162
II32801M1	SB7659	¹⁾ II32801 (SB7659)	162	II33433	SB7596	¹⁾	162
II32802	SB7660	¹⁾	162	II33433AT	–	¹⁾	162
II32802AT	–	¹⁾	162	II33433M1	SB7596	¹⁾ II33433 (SB7596)	162
II32803	SB7670	¹⁾	162	II33438	SB7668	¹⁾ II37791 (SB7789)	165
II32803AT	–	¹⁾	162	II33520	BS9193	¹⁾ II37520 (BS9193)	147
II32804	SB6506	¹⁾ II36703 (SB6506)	164	II33631	SB7678	¹⁾ II37792 (SB7799)	165
II32805	SB6516	¹⁾ II36704 (SB6516)	164	II33648	BS9296	¹⁾ K007642 (BS9296)	148
II32806	SB6507	¹⁾	162	II33675	BZ9447	²⁾ II33675000 (BZ9447)	139
II32806AT	–	¹⁾	162	II33675000	BZ9447		139
II32807	SB6517	¹⁾	162	II33679	BS9510	²⁾ K018094N00 (BS9510)	149
II32807AT	–	¹⁾	162	II33679000	BS9510	²⁾ K018094N00 (BS9510)	149
II32809AT	–	¹⁾ II32798AT	162	II33767000	BS9320	²⁾ K002857N00 (BS9320)	148
II32810AT	–	¹⁾ II32803AT	162	II33770000	BS9321	²⁾ K002856N00 (BS9321)	148
II32812	SB7103	¹⁾	162	II33856	AE4611		41
II32812AT	–	¹⁾	162	II33903	BS3528	²⁾ K015592 (BS3528)	134
II32812M2	SB7103	¹⁾ II32812 (SB7103)	162	II33981	SB7682	¹⁾	162
II32813	SB7113	¹⁾	162	II33981AT	–	¹⁾	162
II32813AT	–	¹⁾	162	II33981M1	SB7682	¹⁾ II33981 (SB7682)	162
II32813M2	SB7113	¹⁾ II32813 (SB7113)	162	II33981M2	SB7682	¹⁾ II33981 (SB7682)	162
II32920	SZ1190		223	II33981V1	SB7682	¹⁾	162

Products in Part Number order
Produkte, nach Teilenummern geordnet

Classification des Produits par Numero
Prodotti ordinati per Codice

Part Number	Type Number	Replacement/Remplacé par Ersatz / Sostituito da	Page	Part Number	Type Number	Replacement/Remplacé par Ersatz / Sostituito da	Page
II33981V2	SB7682	¹⁾	162	II34487	SB7721	¹⁾	163
II33982	SB7692	¹⁾	163	II34487AT	–	¹⁾	163
II33982AT	–	¹⁾	163	II34488	SB7731	¹⁾	163
II33982V1	SB7692	¹⁾	163	II34488AT	–	¹⁾	163
II33982V2	SB7692	¹⁾	163	II34498	SB7105	¹⁾	163
II33996	BS9517	¹⁾ II39614F (BS8519)	147	II34592	SB7580	¹⁾ II34323 (SB7701)	162
II33999	BS9354	²⁾ K009968 (BT4800)	150	II34593	SB7590	¹⁾ II34324 (SB7711)	162
II34000	BS9421		148	II34594	SB7707	¹⁾	163
II34017	BY9505		143	II34594AT	–	¹⁾	163
II34069	LK3826		12	II34595	SB7717	¹⁾	163
II34161	SB6520	¹⁾	163	II34595AT	–	¹⁾	163
II34161AT	–	¹⁾	163	II34598	SB7708	¹⁾	163
II34161M1	SB6520	¹⁾ II34161 (SB6520)	162	II34598AT	–	¹⁾	163
II34162	SB6530	¹⁾	163	II34599	SB7718	¹⁾	163
II34162AT	–	¹⁾	163	II34599AT	–	¹⁾	163
II34162M1	SB6530	¹⁾ II34162 (SB6530)	162	II34603	SB7688	¹⁾	163
II34184	BS9355	²⁾ K009969 (BT4801)	150	II34603AT	–	¹⁾	163
II34185	BS9424		148	II34604	SB7698	¹⁾	163
II34198	BS9527	²⁾ K017123N00 (BS9527)	149	II34604AT	–	¹⁾	163
II34323	SB7701	¹⁾	163	II34747	RE2230	¹⁾ AC596A	64
II34323AT	–	²⁾	163	II34820	SB7723	¹⁾	163
II34324	SB7711	¹⁾	163	II34821	SB7733	¹⁾	163
II34324AT	–	²⁾	163	II34840	LP4823	¹⁾ SEB01782000 (LP4823)	16
II34325	SB7702	¹⁾	163	II34841	LP4830	¹⁾ SEB01781 (LP4830)	16
II34325AT	–	¹⁾	163	II34894	SB7665	¹⁾ II33982 (SB7692)	162
II34326	SB7712	¹⁾	163	II34894AT	–	¹⁾ II33982AT	162
II34326AT	–	¹⁾	163	II34895	SB7675	¹⁾ II33981 (SB7682)	162
II34388	BS9520		149	II34895AT	–	¹⁾ II33981AT	162
II34389	BS9458		149	II34898	SB7105	¹⁾	163
II34404	LP4969	²⁾ II34404N00 (LP4969)	16	II34898AT	–	¹⁾	163
II34404N00	LP4969		16	II34899	SB7115	¹⁾	163
II34452	SB7703	¹⁾	163	II34899AT	–	¹⁾	163
II34452AT	–	¹⁾	163	II34910	SV1447		197
II34453	SB7713	¹⁾	163	II34976	LA8040	²⁾ II34976N00 (LA8040)	19
II34453AT	–	¹⁾	163	II34976N00	LA8040		19
II34454	SB7704	¹⁾	163	II34979	–	²⁾ II40100F	30
II34454AT	–	¹⁾	163	II35053	SB7659	¹⁾ II32801 (SB7659)	162
II34455	SB7714	¹⁾	163	II35054	SB7649	¹⁾ II32800 (SB7649)	162
II34455AT	–	¹⁾	163	II35055	SB7670	¹⁾ II32803 (SB7670)	162
II34456	SB7705	¹⁾	163	II35056	SB7660	¹⁾ II32802 (SB7660)	162
II34456AT	–	¹⁾	163	II35057	SB7658	¹⁾ II32799 (SB7658)	162
II34457	SB7715	¹⁾	163	II35058	SB7648	¹⁾ II32798 (SB7648)	162
II34457AT	–	¹⁾	163	II35117	BY9321	²⁾ II35117000 (BY9321)	144
II34458AT	–		163	II35117000	BY9321		144
II34459AT	–		163	II35396	SB7108	¹⁾	163
II34464	SB7709	¹⁾	163	II35396AT	–	¹⁾	163
II34465	SB7719	¹⁾	163	II35397	SB7118	¹⁾	163
II34465AT	–	¹⁾	163	II35397AT	–	¹⁾	163

Products in Part Number order
Produkte, nach Teilenummern geordnet

Classification des Produits par Numero
Prodotti ordinati per Codice

Part Number	Type Number	Replacement/Remplacé par Ersatz / Sostituito da	Page	Part Number	Type Number	Replacement/Remplacé par Ersatz / Sostituito da	Page
II35401	SB7724	¹⁾	163	II36008	AE4506	¹⁾ II38797F (AE4506)	40
II35401AT	–	¹⁾	163	II36011000	AE4603		40
II35402	SB7734	¹⁾	163	II36012000	AE4604		40
II35402AT	–	¹⁾	163	II36017	RE2131		62
II35403	SB7725	¹⁾ II37021 (SB7725)	164	II36018	RE2131	¹⁾ II36017 (RE2131)	62
II35404	SB7735	¹⁾ II37022 (SB7735)	164	II36021	DB2142		63
II35416/3000	EK3003	¹⁾ II354163000 (EK3003)	121	II36022	DB2142	¹⁾ II36021 (DB2142)	63
II35416/6000	EK3003	¹⁾ II354166000 (EK3003)	122	II36045	MB4694		48
II354163000	EK3003		121	II36055	AE4264		78
II354166000	EK3003		122	II36060	MB4763		48
II35434/3000	EZ1020	¹⁾ II354343000 (EZ1020)	94	II36061	AE4265		78
II354343000	EZ1020		94	II36075	SV3162		200
II35462	BR9157		83	II36087	EE4207		32
II35522	LA8269		21	II36099	SV1463	¹⁾ II36115 (SV1466)	197
II35523	LA8270		21	II36100	SV1463	¹⁾ II36115 (SV1466)	197
II35525	AE4459		40	II36108	SV1318		197
II35526	LA8044		19	II36115	SV1466		197
II35530	ZB4511	²⁾ K025294N00 (ZB4721)	24	II36117	SV1467		197
II35530170	ZB4511	²⁾ K025294N00 (ZB4721)	24	II36118	SV1468		197
II35530AT	–	¹⁾ K025294N00 (ZB4721)	24	II36120	MB4847	¹⁾ II36174000 (MB4849)	48
II35531	ZB4512	²⁾ K025294N00 (ZB4721)	24	II36121	SV1470		198
II35531170	ZB4512	²⁾ K025294N00 (ZB4721)	24	II36128	AE4230		77, 108
II35531AT	–	¹⁾ K025294N00 (ZB4721)	24	II36129	AE4247		77, 108
II35540	SB7726	¹⁾	163	II36131	AE4247		77, 108
II35540AT	–	¹⁾	163	II36133	AE4232		78
II35541	SB7736	¹⁾	163	II36134	AE4233		78
II35541AT	–	¹⁾	163	II36142	SV1463	²⁾ II36115 (SV1466)	197
II35564	LP4850	²⁾ II35564000 (LP4850)	16	II36146	DR4135	¹⁾ K000622 (DR4159)	38
II35564000	LP4850		16	II36150	AE4615		41
II35696	VG3264		208	II36151	SV3230		200
II35736	BS9356		148	II36169	SV1481		198
II35736000	BS9356	¹⁾ II35736 (BS9356)	148	II36171	SV1482		198
II35800	SB7724	¹⁾ II39264F (SB7724)	167	II36174	MB4849	²⁾ II36174000 (MB4849)	48
II35801	SB7734	¹⁾ II39265F (SB7734)	167	II36174000	MB4849		48
II35813	SB7649	¹⁾ II38726F (SB7649)	166	II36177	DR4335	¹⁾ K000643 (DR4377)	38
II35813AT	–	¹⁾ II38726FAT	166	II36178	KU1400	¹⁾ K000952 (KU1400)	67
II35814	SB7659	¹⁾ II38727F (SB7659)	166	II36180	KU1410	¹⁾ K000954 (KU1410)	67
II35814AT	–	¹⁾ II38727FAT	166	II36181	KU1411	¹⁾ K000955 (KU1411)	67
II35815	SB7648	¹⁾ II38724F (SB7648)	166	II36184	SV3203	²⁾ K002018 (SV3240)	108, 200
II35816	SB7658	¹⁾ II38725F (SB7658)	166	II36212	SV1483		198
II35957	SB7729		163	II36219	DB2116		63
II35957AT	–	¹⁾	163	II36224	AE1141	¹⁾ K008546 (AE1141)	108, 206
II35958	SB7739		163	II36257	LA8272	²⁾ II36257N00 (LA8272)	22
II35958AT	–	¹⁾	163	II36257N00	LA8272		22
II35964	SB7742	¹⁾	163	II36293	MB4833		48
II35965	SB7752	¹⁾	163	II36296	MB4836		48
II36006	ZB4513	¹⁾ II39866F (ZB4564)	23	II36299	MB4821		48
II36007	LA9004		22, 23	II36300	MB4820		48

Products in Part Number order
Produkte, nach Teilenummern geordnet

Classification des Produits par Numero
Prodotti ordinati per Codice

Part Number	Type Number	Replacement/Remplacé par Ersatz / Sostituito da	Page	Part Number	Type Number	Replacement/Remplacé par Ersatz / Sostituito da	Page
II36302	MB4815		48	II36701	SB6507	¹⁾	164
II36364	MB4813		48	II36701AT	–	¹⁾	164
II36373	VG3265		209	II36702	SB6517	¹⁾	164
II36377	VG3267		209	II36702AT	–	¹⁾	164
II36379	VG3269		209	II36703	SB6506	¹⁾	164
II36381	EZ1022		94	II36703AT	–	¹⁾	164
II36413	ES2005		92	II36704	SB6516	¹⁾	164
II36430	SB7109	¹⁾	163	II36704AT	–	¹⁾	164
II36430AT	–	¹⁾	163	II36705	SB6507	¹⁾	164
II36431	SB7119	¹⁾	163	II36705AT	–	¹⁾	164
II36431AT	–	¹⁾	163	II36706	SB6517	¹⁾	164
II36490	SB7989	¹⁾	163	II36706AT	–	¹⁾	164
II36490AT	–	¹⁾	163	II36724	BY9322	²⁾ K003964N00 (BY9322)	144
II36491	SB7999	¹⁾	163	II36725	BY9323	²⁾ K004064N00 (BY9323)	144
II36491AT	–	¹⁾	163	II36739/7	EK3100	¹⁾ II367397 (EK3100)	116, 124
II36503	SB7120	¹⁾	163	II367397	EK3100		116, 124
II36504	SB7130	¹⁾	163	II36741/12000	EK3110	¹⁾ II3674112000 (EK3110)	116
II36650	AE4605		40	II36741/15000	EK3110	¹⁾ II3674115000 (EK3110)	116
II36681	SB5003	¹⁾	164	II3674112000	EK3110		116
II36681AT	–	¹⁾	164	II3674115000	EK3110		116
II36682	SB5013	¹⁾	164	II36753	EK3800		120
II36682AT	–	¹⁾	164	II36756/3000	EK3130	¹⁾ II367563000 (EK3130)	91, 111, 122
II36683	SB5002	¹⁾	164	II36756/5000	EK3130	¹⁾ II367565000 (EK3130)	91, 111, 122
II36683AT	SB5002	¹⁾	164	II36756/6000	EK3130	¹⁾ II367566000 (EK3130)	91, 111, 122
II36684	SB5012	¹⁾	164	II3675610000	EK3130		91, 111, 122
II36684AT	SB5012	¹⁾	164	II3675612000	EK3130		91, 111
II36685	SB5003	¹⁾	164	II3675615000	EK3130		91, 111, 122
II36685AT	–	¹⁾	164	II367562000	EK3130		91, 111, 122
II36686	SB5013	¹⁾	164	II367563000	EK3130		91, 111, 122
II36686AT	–	¹⁾	164	II367564000	EK3130		91, 111, 122
II36687	SB5002	¹⁾	164	II367565000	EK3130		91, 111, 122
II36688	SB5012	¹⁾	164	II367566000	EK3130		91, 111, 122
II36689	SB7648	¹⁾	164	II367568000	EK3130		91, 111, 122
II36689AT	–		164	II36778	BS3354	²⁾ K003030 (BS3354)	133
II36690	SB7658	¹⁾	164	II36780	BS3458	¹⁾ K003012 (BS3458)	134
II36690AT	–	¹⁾	164	II36781	BS3532	¹⁾ K002420 (BS3532)	134
II36691	SB7649	¹⁾	164	II36805	SB7757	¹⁾	164
II36691AT	–	¹⁾	164	II36805AT	–	¹⁾	164
II36692	SB7659	¹⁾	164	II36818	BR5530		58
II36692AT	–	¹⁾	164	II36826	BR4465		57
II36693	SB7660	¹⁾	164	II36828	BR4467		57
II36693AT	–	¹⁾ K002363DC	172	II36829	BR4468		57
II36694	SB7670	¹⁾	164	II36833	BR5522	¹⁾ II36836 (BR5522)	58
II36694AT	–	¹⁾	164	II36836	BR5522		58
II36699	SB6506	¹⁾	164	II36838	–	¹⁾ II36836 (BR5522)	58
II36699AT	–	¹⁾	164	II36925	LK3980		13
II36700	SB6516	¹⁾	164	II36925000	LK3980	²⁾ II36925 (LK3980)	13
II36700AT	–	¹⁾	164	II36933	LA6734	²⁾ K023357 (LA8702)	22

Products in Part Number order
Produkte, nach Teilenummern geordnet

Classification des Produits par Numero
Prodotti ordinati per Codice

Part Number	Type Number	Replacement/Remplacé par Ersatz / Sostituito da	Page	Part Number	Type Number	Replacement/Remplacé par Ersatz / Sostituito da	Page
II36935	LA6710	²⁾ II36935000 (LA6710)	19	II37062	SB7658	¹⁾	164
II36935000	LA6710		19	II37062AT	–	¹⁾	164
II36936	LA6711	²⁾ II36936000 (LA6711)	19	II37062DC	–	¹⁾	165
II36936000	LA6711		19	II37064	SB7659	¹⁾	165
II36944	BX7523	²⁾ K031739N00 (BX7523)	141	II37064AT	–	¹⁾	165
II36946	BX7525	²⁾ K031740N00 (BX7525)	141	II37068	SB7765	¹⁾ II38367F (SB7765)	166
II36962	BS9433	²⁾ K007661 (BS9433)	148	II37069	SB7775	¹⁾ II38368F (SB7775)	166
II36967	BS3201	²⁾ K008766 (BS3201)	133	II37070	SB7766	¹⁾ II38730F (SB7766)	166
II36969	BS3313	²⁾ K003840 (BS3313)	133	II37071	SB7776	¹⁾ II38731F (SB7776)	166
II36972	BS9434	²⁾ K007662 (BS9434)	148	II37077	SB7760	¹⁾	165
II36972F	BS9434	¹⁾ K007662 (BS9434)	148	II37077AT	–	¹⁾	165
II36999	SB7760	¹⁾	164	II37078	SB7770	¹⁾	165
II36999AT	–	¹⁾	164	II37078AT	–	¹⁾ K003351AT	172
II37000	SB7770	¹⁾	164	II37080	SB7767	¹⁾	165
II37000AT	–	¹⁾	164	II37080AT	–	¹⁾	165
II37001	SB7761	¹⁾	164	II37080M1	SB7767	¹⁾ II37080 (SB7767)	164
II37001AT	–	¹⁾	164	II37081	SB7777	¹⁾	165
II37002	SB7771	¹⁾	164	II37081AT	–	¹⁾	165
II37002AT	–	¹⁾	164	II37081M1	SB7777	¹⁾ II37081 (SB7777)	164
II37006	SB7680	¹⁾	164	II37083N50	EA2000		96
II37006AT	–	¹⁾	164	II37086	BR9180	¹⁾ II17776N00 (BR9154)	83
II37007	SB7690	¹⁾	164	II37090N00	BR9233		92
II37007AT	–	¹⁾	164	II37091	–	²⁾ II37091N00 (BR9234)	89
II37015	SB7703	¹⁾	164	II37091N00	BR9234		89, 93
II37015AT	–	¹⁾	164	II37099	–		153
II37016	SB7713	¹⁾	164	II37127	BS3538		134
II37016AT	–	¹⁾	164	II37133	BS3536	²⁾ K015589 (BS3536)	134
II37017	SB7704	¹⁾	164	II37134	BS3537	²⁾ K015590 (BS3537)	134
II37017AT	–	¹⁾	164	II37138	BS9390	²⁾ II37138000 (BS9390)	148
II37018	SB7714	¹⁾	164	II37138000	BS9390		148
II37018AT	–	¹⁾	164	II37139	BS9391	²⁾ II37139000 (BS9391)	148
II37019	SB7707	¹⁾	164	II37139000	BS9391		148
II37019AT	–	¹⁾	164	II37140	BS3315	²⁾ II37140000 (BS3315)	133
II37020	SB7717	¹⁾	164	II37140000	BS3315		133
II37020AT	–		164	II37145	BY9506		143
II37021	SB7725	¹⁾	164	II37151	AB2851		65
II37022	SB7735	¹⁾	164	II37166	BR5657		58
II37025	SB6525	¹⁾	164	II37167	BR5658		58
II37025AT	–	¹⁾	164	II37181	MB9000	²⁾ II37181N50 (MB9000)	99
II37026	SB6535	¹⁾	164	II37181N50	MB9000		99
II37026AT	–	¹⁾	164	II37191	–		183
II37029	SB7762	¹⁾	164	II371910061	–		183
II37029AT	–	¹⁾	164	II37209	SB7765	¹⁾ II38367F (SB7765)	166
II37030	SB7772	¹⁾	164	II37210	SB7775	¹⁾ II38368F (SB7775)	166
II37030AT	–	¹⁾	164	II37214	LP4974	¹⁾ K000236000 (LP4974)	16
II37061	SB7648	¹⁾	164	II37223	SB6503	¹⁾	165
II37061AT	–	¹⁾	164	II37223AT	–	¹⁾	165
II37061DC	–	¹⁾	164	II37224	SB6513	¹⁾	165

Products in Part Number order
Produkte, nach Teilenummern geordnet

Classification des Produits par Numero
Prodotti ordinati per Codice

Part Number	Type Number	Replacement/Remplacé par Ersatz / Sostituito da	Page	Part Number	Type Number	Replacement/Remplacé par Ersatz / Sostituito da	Page
II37224AT	-	¹⁾	165	II37421	SB7767	¹⁾ Z0011471 (SB7767)	180
II37225	SB6508		165	II37422	SB7777	¹⁾ Z0011472 (SB7777)	180
II37226	SB6518		165	II37423	SB7122	¹⁾	165
II37231	SB7780	¹⁾	165	II37423AT	-	¹⁾	165
II37231AT	-	¹⁾	165	II37423M1	SB7122	¹⁾ II37423 (SB7122)	165
II37232	SB7790	¹⁾	165	II37424	SB7132	¹⁾	165
II37232AT	-	¹⁾ K003250AT	172	II37424AT	-	¹⁾	165
II37236AT	-	¹⁾ K000136AT	167	II37424M1	SB7132	¹⁾ II37424 (SB7132)	165
II37237AT	-	¹⁾ K000137AT	167	II37460	AE4609		41
II37239	SB7726	¹⁾ Z0021043 (SB7608)	181	II37461N50	AE4608		24, 41
II37240	SB7736	¹⁾ Z0021044 (SB7618)	181	II37463	AE4527		24, 40
II37241	-	¹⁾ II37784	183	II37463M2	AE4527	¹⁾ II37463 (AE4527)	24, 40
II37246	SB7782	¹⁾	165	II37464N50	AE4528		23, 24, 40
II37246AT	-	¹⁾	165	II37468	BS9535		149
II37247	SB7792	¹⁾	165	II37520	BS9193		147
II37247AT	-	¹⁾	165	II37638/0061	-	¹⁾ II376380061	183
II37252	SB6527	¹⁾ Z0016511AT	181	II376380061	-		183
II37253	SB6537	¹⁾ Z0016512AT	181	II376530061	-		183
II37253AT	-	¹⁾ Z0016512AT	181	II37654	-		183
II37266	BS9437	²⁾ K004042N00 (BS9437)	149	II37656	-	²⁾ II37986	183
II37267	BS9438	²⁾ K004043N00 (BS9438)	149	II37679	AE4502	¹⁾ K011931 (AE4502)	23, 24, 40
II37274	BX9400		139	II37680	AE4510	²⁾ II37680N50 (AE4510)	23, 24, 40
II37282	BS9534		149	II37680N50	AE4510		23, 24, 40
II37312	BY9411		143	II37686	SB6527	¹⁾	165
II37313	BY9412		143	II37686AT	-	¹⁾	165
II37315	BS3316	²⁾ K015579 (BS3316)	133	II37686M1	SB6527	¹⁾ II37686 (SB6527)	165
II37316	BS3317	²⁾ K015580 (BS3317)	133	II37687	SB6537	¹⁾	165
II37325AT	-	¹⁾ II37025AT	164	II37687AT	-	¹⁾	165
II37380	SB7783	¹⁾	165	II37687M1	SB6537	¹⁾ II37687 (SB6537)	165
II37381	SB7793	¹⁾	165	II37690	SB6528	¹⁾	165
II37390	SB7784	¹⁾	165	II37690AT	-	¹⁾	165
II37390AT	-	¹⁾	165	II37691	SB6538	¹⁾	165
II37391	SB7794	¹⁾	165	II37691AT	-	¹⁾	165
II37391AT	-	¹⁾	165	II37699	SB7757	¹⁾	165
II37392	SB7785	¹⁾	165	II37730	BY3406		130
II37392AT	-	¹⁾	165	II37731	BY3509		130
II37393	SB7795	¹⁾	165	II37747	BS9536	²⁾ II37747000 (BS9536)	149
II37393AT	-	¹⁾	165	II37747000	BS9536		149
II37398	SB7787	¹⁾	165	II37752	LP4984	¹⁾ SEB01783000 (LP4984)	16
II37398AT	-	¹⁾	165	II37760	LP4985	¹⁾ K000229000 (LP4985)	16
II37398M1	SB7787	¹⁾ II37398 (SB7787)	165	II37783	-		183
II37398M2	SB7787	¹⁾ II37398 (SB7787)	165	II37784	-		183
II37399	SB7797	¹⁾	165	II37791	SB7789	¹⁾	165
II37399AT	-	¹⁾	165	II37791AT	-	¹⁾	165
II37399M2	SB7797	¹⁾ II37399 (SB7797)	165	II37792	SB7799	¹⁾	165
II37415	-		183	II37792AT	-	¹⁾	165
II37419	SB7708	¹⁾	165	II37793	SB7800	¹⁾	165
II37420	SB7718	¹⁾	165	II37793AT	-	¹⁾	165

Products in Part Number order
Produkte, nach Teilenummern geordnet

Classification des Produits par Numero
Prodotti ordinati per Codice

Part Number	Type Number	Replacement/Remplacé par Ersatz / Sostituito da	Page	Part Number	Type Number	Replacement/Remplacé par Ersatz / Sostituito da	Page
II37794	SB7810	¹⁾	165	II37921N00	LA8049	²⁾ K020337N00 (LA8075)	20
II37794AT	–	¹⁾	165	II37922	AE4525		40
II37795AT	–	¹⁾ II38810FAT	166	II37924	LA8050		20
II37797	SB6507	¹⁾	165	II37926	LA8011	²⁾ II37926N00 (LA8011)	19
II37797AT	–	¹⁾	165	II37926N00	LA8011		19
II37798	SB6517	¹⁾	165	II37927	LA8016	²⁾ II37927N00 (LA8016)	19
II37798AT	–	¹⁾	165	II37927N00	LA8016		19
II37799	SB6507	¹⁾	165	II37928	LA8041	²⁾ II37928N00 (LA8041)	19
II37799AT	–	¹⁾	165	II37928N00	LA8041		19
II37800	SB6517	¹⁾	165	II37928R	LA8041	²⁾ II37928N00 (LA8041)	19
II37800AT	–	¹⁾	165	II37933	VG3268		209
II37801	SB6525	¹⁾	165	II37940	VG3365		209
II37801AT	–	¹⁾	165	II37951	–	²⁾ II37951004	232
II37802	SB6535	¹⁾	165	II37951004	–		232
II37802AT	–	¹⁾	165	II37951004EN	–		232
II37803	SB5003	¹⁾	165	II37951004EX	ZB9032	²⁾ II37951004EN	232
II37803AT	–	¹⁾	165	II37983/0061	–	¹⁾ II379830061	183
II37804	SB5013	¹⁾	165	II379830061	–		183
II37804AT	–	¹⁾	165	II37986	–		183
II37805	SB5003	¹⁾	165	II379861	–	¹⁾ II37986	183
II37805AT	–	¹⁾	165	II37987	–	²⁾ II37986	183
II37806	SB5013	¹⁾	165	II37988	–		183
II37806AT	–	¹⁾	165	II379881	–	¹⁾ II37988	183
II37808	SB7801	¹⁾	165	II38005F	ZB4545	¹⁾ K000394N00 (ZB4578)	23
II37808AT	–	¹⁾	165	II38036F	SB7108	¹⁾ II37814 (SB7124)	165
II37808M1	SB7801	¹⁾ II37808 (SB7801)	165	II38037F	SB7118	¹⁾ II37815 (SB7134)	165
II37809	SB7811	¹⁾	166	II38038F	SB7803	¹⁾	166
II37809AT	–	¹⁾	166	II38039F	SB7813	¹⁾	166
II37809M1	SB7811	¹⁾ II37809 (SB7811)	165	II38039FAT	–	¹⁾	166
II37810	SB6529	¹⁾	166	II38042F	–	¹⁾ II39036F (SB6540)	166
II37810AT	–	¹⁾	166	II38043F	–	¹⁾ II39037F (SB6550)	166
II37811	SB6539	¹⁾	166	II38046F	SB7801	¹⁾ Z0011491AT	180
II37811AT	–	¹⁾	166	II38047F	SB7811	¹⁾ Z0011492AT	180
II37812	SB7123	¹⁾	166	II38085	BS9541		149
II37812AT	–	¹⁾	166	II38111F	BS3321		133
II37813	SB7133	¹⁾	166	II38116F	BS9462	²⁾ K007659 (BS9462)	149
II37813AT	–	¹⁾	166	II38124F	BS9471		149
II37814	SB7124	¹⁾	166	II38131F	BZ9330		139
II37814AT	–	¹⁾	166	II38302F	LA8104	²⁾ II38302FN00 (LA8104)	20, 24
II37815	SB7134	¹⁾	166	II38302FN00	LA8104		20, 24
II37815AT	–	¹⁾	166	II38303F	LA8105	²⁾ II38303FN00 (LA8105)	20, 24
II37816	SB7125	¹⁾	166	II38303FN00	LA8105		20, 24
II37816AT	–	¹⁾	166	II38304F	LA8106	²⁾ II38304FN00 (LA8106)	20, 24
II37817	SB7135	¹⁾	166	II38304FN00	LA8106		20, 24
II37817AT	–	¹⁾	166	II38305F	LA8107	²⁾ II38305FN00 (LA8107)	20, 24
II37863F	–	¹⁾ K006510N00 (BS2306)	132	II38305FN00	LA8107		20, 24
II37865	BS3424	¹⁾ K006648N00 (BS2429)	132	II38308F	LA9010	²⁾ II38308FN00 (LA9010)	22, 23
II37906	BS9461		149	II38308FN00	LA9010		22, 23

Products in Part Number order
Produkte, nach Teilenummern geordnet

Classification des Produits par Numero
Prodotti ordinati per Codice

Part Number	Type Number	Replacement/Remplacé par Ersatz / Sostituito da	Page	Part Number	Type Number	Replacement/Remplacé par Ersatz / Sostituito da	Page
II38309F	LA9011	²⁾ II38308FN00 (LA9010)	22, 23	II38497F	BS9378		148
II38309FN00	LA9011		22	II38524F	BS7304	²⁾ K026894N00 (BS7304)	151
II38310F	ZB4534	²⁾ II38310FN00 (ZB4534)	23	II38525F	BS7351	²⁾ K026903N00 (BS7351)	151
II38310FN00	ZB4534		23	II38527F	BS3358		133
II38311F	ZB4535	²⁾ II38310FN00 (ZB4534)	23	II38528F	BS3436		134
II38335F	–		183	II38529F	BS3462		134
II38340F	SB7127	¹⁾	166	II38533F	BS9479		149
II38340FAT	–	¹⁾	166	II38547F	BS8506		146
II38340FM1	SB7127	¹⁾ II38340F (SB7127)	166	II38551F	BS9480	¹⁾ K004040N00 (BS9480)	149
II38341F	SB7137	¹⁾	166	II38552F	BS9481	¹⁾ K004041N00 (BS9481)	149
II38341FAT	–	¹⁾	166	II38568F	BS9482	²⁾ K007665 (BS9482)	149
II38341FM1	SB7137	¹⁾ II38341F (SB7137)	166	II38569F	BS9483	²⁾ K007666 (BS9483)	149
II38342F	SB7128	¹⁾	166	II38599F	BS9486		149
II38343F	SB7138	¹⁾	166	II38619F	ZB4544	²⁾ II38619FN00 (ZB4544)	23
II38344F	SB7129	¹⁾ Z0021181 (SB7182)	182	II38619F000	ZB4544	²⁾ II38619FN00 (ZB4544)	23
II38344FAT	–	¹⁾ Z0021181 (SB7182)	182	II38619FN00	ZB4544		23
II38345F	SB7139	¹⁾ Z0021182 (SB7192)	182	II38620F	LA8116	²⁾ II38620FN00 (LA8116)	20, 23
II38345FAT	–	¹⁾ Z0021182 (SB7192)	182	II38620F000	LA8116	²⁾ II38620FN00 (LA8116)	20, 23
II38350F	SB7724	¹⁾	166	II38620FN00	LA8116		20, 23
II38350FAT	–	¹⁾	166	II38628F	–		183
II38351F	SB7734	¹⁾	166	II38630F	SB7807	¹⁾	166
II38352F	SB7800	¹⁾	166	II38630FM1	SB7807	¹⁾ Z000276 (SB7829)	180
II38352FAT	–	¹⁾	166	II38631F	SB7817	¹⁾	166
II38353F	SB7810	¹⁾	166	II38631FM1	SB7807	¹⁾ Z000277 (SB7839)	180
II38353FAT	–	¹⁾	166	II38632F	SB5006	¹⁾ K002520 (SB5016)	172
II38363F	SB7806	¹⁾	166	II38633F	SB5016	¹⁾ K002519 (SB5006)	172
II38363FAT	–	¹⁾ K000051AT	167	II38634F	SB7809	¹⁾	166
II38364F	SB7816	¹⁾	166	II38635F	SB7819	¹⁾	166
II38364FAT	–	¹⁾ K000052AT	167	II38648F	SB7140	¹⁾	166
II38367F	SB7765	¹⁾	166	II38648FAT	–	¹⁾	166
II38367FM1	SB7765	¹⁾ II39544F (SB7828)	167	II38649F	SB7150	¹⁾	166
II38368F	SB7775	¹⁾	166	II38649FAT	–	¹⁾	166
II38408F	BS9476		149	II38659F	BR9163		83
II38413F	BS3434	²⁾ K004485N00 (BS3434)	134	II38660F	BR9164	²⁾	83
II38413FN00	BS3434	²⁾ K004485N00 (BS3434)	134	II38660FM1	–	¹⁾ II38660F (BR9164)	83
II38414F	BS3435	²⁾ K004486N00 (BS3435)	134	II38660FM2	BR9164	¹⁾ II38660F (BR9164)	83
II38414FN00	BS3435	²⁾ K004486N00 (BS3435)	134	II38661F	BR9165	¹⁾ II38660F (BR9164)	83
II38428F	BS9287		148	II38665F	BR9182	²⁾ II17776N00 (BR9154)	83
II38465F	BS9379		148	II38672F	LA8117	²⁾ K000390N00 (LA8130)	20, 23
II38466F	BS3326		133	II38677F	AE4503		24, 40
II38466F000	BS3326	¹⁾ II38466F (BS3326)	133	II38677FM2	AE4503	¹⁾ II38677F (AE4503)	24, 40
II38467F	BS9338		148	II38724F	SB7648	¹⁾	166
II38470F000	BS8500	²⁾ K017119N00 (BS8500)	146	II38725F	SB7658	¹⁾	166
II38471F000	BS8501	²⁾ K017120N00 (BS8501)	146	II38726F	SB7649	¹⁾	166
II38488F	BS9092	²⁾ K007625 (BS9092)	147	II38726FAT	–	¹⁾	166
II38489F	–	¹⁾ K007626 (BS9093)	147	II38727F	SB7659	¹⁾	166
II38496F	BS9377		148	II38727FAT	–	¹⁾	166
II38496F000	BS9377	¹⁾ II38496F (BS9377)	148	II38728F	SB7660	¹⁾ Z0010003 (SN7021)	180

Products in Part Number order
Produkte, nach Teilenummern geordnet

Classification des Produits par Numero
Prodotti ordinati per Codice

Part Number	Type Number	Replacement/Remplacé par Ersatz / Sostituito da	Page
II38729F	SB7670	¹⁾ Z0010004 (SN7031)	180
II38730F	SB7766	¹⁾	166
II38731F	SB7776	¹⁾	166
II38749F	AE4529		23, 24
II38749F004	AE4529		40
II38749F0041	AE4529	¹⁾ II38749F004 (AE4529)	40
II38749FM2	AE4529	¹⁾ II38749F (AE4529)	23, 24
II38775F	LK1565		12
II38779F	LP4993	¹⁾ K001267000 (LK4918)	15
II38785F	LA8118	²⁾ K000391N00 (LA8131)	20, 23
II38785F000	LA8118	¹⁾ K000391N00 (LA8131)	20, 23
II38786F	LA8057	²⁾	20
II38787F	LA8058	²⁾ K016602N00 (LA8074)	20
II38787FN00	LA8058	²⁾ K016602N00 (LA8074)	20
II38789F	–	²⁾ II38789F004	30
II38789F004	–		30
II38797F	AE4506		23, 40
II38798F	LA8060		20
II38800F	LA8119	²⁾ K000392N00 (LA8132)	20, 23
II38801F	AE4612		41
II38802F	AE4613		41
II38802FM1	AE4613	¹⁾ II36150 (AE4615)	41
II38810F	SB7800	¹⁾	166
II38810FAT	–	¹⁾	166
II38811F	SB7810	¹⁾	166
II38811FAT	–	¹⁾ Z0017522AT	181
II38816F	SB7820	¹⁾	166
II38817F	SB7830	¹⁾	166
II38821F	RE3311		61
II38840FM1	SB7761	¹⁾ II37001 (SB7761)	164
II38841FM1	SB7771	¹⁾ II37002 (SB7771)	164
II38922F	BS8516		147
II39000F	SB7766	¹⁾	166
II39000FAT	–	¹⁾	166
II39001F	SB7776	¹⁾	166
II39001FAT	–	¹⁾	166
II39002F	SB7144	¹⁾	166
II39003F	SB7154	¹⁾	166
II39003FAT	–	¹⁾	166
II39006F	SB7146	¹⁾	166
II39006FAT	–	¹⁾	166
II39007F	SB7156	¹⁾	166
II39007FAT	–	¹⁾	166
II39010FN50	AE4526		40
II39023F	–		183
II39029AT	–	¹⁾ II37029AT	164
II39030F	SB7148	¹⁾	166
II39031F	SB7158	¹⁾	166

Part Number	Type Number	Replacement/Remplacé par Ersatz / Sostituito da	Page
II39032F	SB7149	¹⁾	166
II39033F	SB7159	¹⁾	166
II39034F	SB7825		166
II39035F	SB7835		166
II39036F	SB6540		166
II39036FAT	–	²⁾	166
II39037F	SB6550		166
II39037FAT	–	²⁾	166
II39038F	SB6540	¹⁾	166
II39039F	SB6550	¹⁾	166
II39044F	SB7762	¹⁾	166
II39044FAT	–	¹⁾	166
II39045F	SB7772	¹⁾	167
II39045FAT	–	¹⁾	167
II39046F	SB6520	¹⁾	167
II39046FAT	–	¹⁾ K000115AT	167
II39046FM1	SB6520	¹⁾ II39046F (SB6520)	166
II39047F	SB6530	¹⁾	167
II39047FAT	–	¹⁾ K000116AT	167
II39047FM1	SB6530	¹⁾ II39047F (SB6530)	166
II39048F	SB6528	¹⁾	167
II39048FAT	–	¹⁾	167
II39049F	SB6538	¹⁾	167
II39049FAT	–	¹⁾	167
II39050F	RE3312	²⁾ II39050F000 (RE3312)	61
II39050F000	RE3312		61
II39054F	LA8061	²⁾ II39054FN00 (LA8061)	20
II39054FN00	LA8061		20
II39054FR	LA8061	²⁾ II39054FN00 (LA8061)	20
II39068F	SB6545		167
II39069F	SB6555		167
II39077F	LK4918	¹⁾ K001267000 (LK4918)	15
II39092F	–		183
II39093F	–		183
II39096F	–		183
II39098F	–		183
II39140F	AE4615		41
II39151F	LK1566		12
II39193F	BS3207	¹⁾ K008768 (BS3207)	133
II39196F	BS3269	¹⁾ K010290 (BS3269)	133
II39199F	BS3362	¹⁾ K003031 (BS3362)	133
II39201F	BS3441	¹⁾ K003021 (BS3441)	134
II39203	BS3467	¹⁾ K003013 (BS3467)	134
II39203F	BS3467	¹⁾ K003013 (BS3467)	134
II39205F	BS2504	¹⁾ K002556 (BS2504)	132
II39212FN00	BS9374		148
II39213F	BS9373		148
II39213FN00	BS9373	²⁾ II39213F (BS9373)	148

Products in Part Number order
Produkte, nach Teilenummern geordnet

Classification des Produits par Numero
Prodotti ordinati per Codice

Part Number	Type Number	Replacement/Remplacé par Ersatz / Sostituito da	Page	Part Number	Type Number	Replacement/Remplacé par Ersatz / Sostituito da	Page
II39218F	BS3335		133	II39595F	BY9230		142
II39219F	BS8517		147	II39613F	BS9468		149
II39219F000	BS8517	²⁾ II39219F (BS8517)	147	II39614F	BS8519		147
II39220F	BS8518		147	II39666F	BY3408		130
II39229F	BY9328	¹⁾ K014032 (BY9328)	143	II39668F	BS9491	¹⁾ K004031000 (BS9491)	149
II39251F	SB6546		167	II39669F	BS9492	¹⁾ K004032000 (BS9492)	149
II39252F	SB6556		167	II39737F	–	²⁾ II41300F	30
II39252FAT	–	¹⁾	167	II39737FM2	–	¹⁾ II41300F	30
II39258F	SB6547	²⁾	167	II39741F	–	¹⁾ II40100F	30
II39258FAT	–	¹⁾	167	II39748F	LA6273	²⁾ K018578 (LA8546)	22
II39258FIV	–	²⁾	167	II39751F00	LA8271		21
II39258FM1	SB6547	¹⁾ II39258F (SB6547)	166	II39751F000	LA8271	¹⁾ II39751F00 (LA8271)	21
II39258FM2	SB6547	¹⁾ II39258F (SB6547)	166	II39752F00	LA8286		22
II39259F	SB6557	²⁾	167	II39752F000	LA8286	¹⁾ II39752F00 (LA8286)	22
II39259FAT	–	¹⁾	167	II39782	ES2053	²⁾ II397824S3M (ES2053)	112
II39259FIV	–	²⁾	167	II397824S3M	ES2053		112
II39259FM1	SB6557	¹⁾ II39259F (SB6557)	167	II39782F004	ES2053	²⁾ II397824S3M (ES2053)	112
II39259FM2	SB6557	¹⁾ II39259F (SB6557)	167	II39782PG	ES2053		112
II39262F	SB7826	¹⁾	167	II39783F	ES2041	²⁾ II397824S3M (ES2053)	112
II39262FAT	–	¹⁾	167	II39783F004	ES2041	²⁾ II397824S3M (ES2053)	112
II39263F	SB7836	¹⁾	167	II397873	EK3122		119
II39264F	SB7724	¹⁾	167	II397883	EK3123		119
II39265F	SB7734	¹⁾	167	II3979312000	EK3115		116
II39266F	SB6548	¹⁾	167	II39808F	EZ1034		124
II39266FM1	SB6548	¹⁾ II39266F (SB6548)	167	II39809F	EZ1031		124
II39267F	SB6558	¹⁾	167	II39812F	EZ1032		124
II39267FM1	SB6558	¹⁾ II39267F (SB6558)	167	II39813F	EZ1033	¹⁾ Z005464 (EZ1033)	124
II39274F	SB6549	¹⁾	167	II39814F1	EK3127		119
II39278F	–		184	II39842	SB7760	¹⁾	167
II39280F	–		184	II39843	SB7770	¹⁾	167
II39284F	–		184	II39844F	SB7146	¹⁾ Z0021243 (SB7169)	182
II39289F	–		184	II39845F	SB7156	¹⁾ Z0021244 (SB7179)	182
II39290F	–		184	II39846	SB7780	¹⁾ K000786 (SN7083)	169
II39294F	SB7600	¹⁾	167	II39847	SB7790	¹⁾ K000787 (SN7093)	169
II39298F	SB7124	¹⁾ Z0021121 (SB7180)	181	II39848	SB7648	¹⁾	167
II39299F	SB7134	¹⁾ Z0021122 (SB7190)	182	II39848AT	–	¹⁾	167
II39355F	BS7309	²⁾ K026896N00 (BS7309)	151	II39849	SB7658	¹⁾	167
II39358F	BY9272		142	II39849AT	–	¹⁾	167
II39374F	BS3336		133	II39866F	ZB4564		23
II39375F	BS3337		133	II39867F	LA6277		19
II39521F	LK3517		12	II39878F	–	²⁾ II40100F	30
II39523F	LK4927		15	II39929F	BS8520	²⁾ II39929FN00 (BS8520)	147
II39544F	SB7828	¹⁾	167	II39929FN00	BS8520		147
II39544FM1	SB7828	¹⁾ Z0015751 (SB7862)	181	II39930F	BS8521	²⁾ II39930FN00 (BS8521)	147
II39545F	SB7838	¹⁾	167	II39930FN00	BS8521		147
II39545FM1	SB7838	¹⁾ Z0015752 (SB7872)	181	II39933F	BS7312	²⁾ K026898N00 (BS7312)	151
II39575F	BS9488	¹⁾ K007138N00 (BS8460)	146	II39934F	BS7313	²⁾ K026899N00 (BS7313)	151
II39576F	BS9489	¹⁾ K007139N00 (BS8461)	146	II39958F	BS8522	²⁾ II39614F (BS8519)	147

Products in Part Number order
Produkte, nach Teilenummern geordnet

Classification des Produits par Numero
Prodotti ordinati per Codice

Part Number	Type Number	Replacement/Remplacé par Ersatz / Sostituito da	Page	Part Number	Type Number	Replacement/Remplacé par Ersatz / Sostituito da	Page
II40096F	VG3276		209	K000008	SB7772	¹⁾	167
II40100F	–		30	K000008AT	–	¹⁾	167
II40116F	EL1500	²⁾ K020741N50 (EL1100)	25	K000011	SB7881		167
II40117F	EL1501	²⁾ K020742N50 (EL1101)	25	K000012	SB7891		167
II40133F	LA8062		20	K000013	SV1465	¹⁾ K000367 (SV1485)	198
II40232F	SB7865	¹⁾	167	K000014	MB4850		48
II40233F	SB7875	¹⁾	167	K000032	–	¹⁾	167
II40284F	ZB4289	²⁾ II40284F000 (ZB4289)	17	K000033	–	¹⁾	167
II40284F000	ZB4289		17	K000035	SB7185	¹⁾	167
II40309F	BS8312	²⁾	145	K000035AT	–	¹⁾	167
II40310F	BS9497	²⁾	149	K000036	SB7195	¹⁾	167
II40311F	BS9498	²⁾	149	K000036AT	–	¹⁾	167
II40321F	BZ9566		139	K000037	SB7186	¹⁾	167
II40329F	STK5382		136	K000038	SB7196	¹⁾	167
II40381F	VG3282		209	K000039	SB7187	¹⁾	167
II40391F2	EK3108		116	K000040	SB7197	¹⁾	167
II40500F	BS8450		146	K000041	SB7187	¹⁾	167
II40554F	LA8124	²⁾ II40554FN00 (LA8124)	20, 23, 24	K000042	SB7197	¹⁾	167
II40554FN00	LA8124		20, 23, 24	K000043	SB7883	²⁾	167
II40555F	LA8125	²⁾ II40555FN00 (LA8125)	20, 23, 24	K000044	SB7893	²⁾	167
II40555FN00	LA8125		20, 23, 24	K000045	SB7884	¹⁾	167
II40556FN00	LA8126		24	K000046	SB7894	¹⁾	167
II40557F	LA8127	²⁾ II40557FN00 (LA8127)	20, 24	K000051	SB7886	²⁾	167
II40557FN00	LA8127		20, 24	K000051AT	–	¹⁾	167
II40558F	LA8128	²⁾ II40558FN00 (LA8128)	20, 24	K000052	SB7896	²⁾	167
II40558FN00	LA8128		20, 24	K000052AT	–	¹⁾	167
II40559F	LA8129	²⁾ II40559FN00 (LA8129)	20, 24	K000053	SB7887	¹⁾	167
II40559FN00	LA8129		20, 24	K000053AT	–	¹⁾	167
II40864F	BR9159	²⁾ II17776N00 (BR9154)	83	K000054	SB7897	¹⁾	167
II40868F	BR9235		93	K000055	AE4463		40
II40872F	BR9166		83	K000065	LA6252		19
II41053F	BR9190		83	K000067	KU1400	²⁾ K000952 (KU1400)	67
II41063F	ZB3169		188	K000068	KU1410	²⁾ K000954 (KU1410)	67
II41119F	BR9191	²⁾ II17776N00 (BR9154)	83	K000069	SV1468		197
II41221F	ZE4600	²⁾	24	K000073	SV1412		197
II41222FN00	EL9000		19, 24	K000079	KU1412	²⁾ K000956 (KU1412)	67
II41300F	–		30	K000085N50	–	²⁾ K021202N50	96
INT46E	–		190	K000086	–	²⁾ K000086N50	97
K000002	SB7880	¹⁾	167	K000086N50	–		97
K000002AT	–	¹⁾ K000386AT	168	K000088	–	²⁾ K000086N50	97
K000003	SB7890	¹⁾	167	K000091	SB7801	¹⁾	167
K000003AT	–	¹⁾ K000387AT	168	K000092	SB7811	¹⁾	167
K000005	SB6528	¹⁾	167	K000095	SB6527	¹⁾	167
K000005AT	–	¹⁾	167	K000096	SB6537	¹⁾	167
K000006	SB6538	¹⁾	167	K000105	SB6548	¹⁾	167
K000006AT	–	¹⁾	167	K000106	SB6558	¹⁾	167
K000007	SB7762	¹⁾	167	K000115	SB6548	¹⁾	167
K000007AT	–	¹⁾	167	K000115AT	–	¹⁾	167

Products in Part Number order
Produkte, nach Teilenummern geordnet

Classification des Produits par Numero
Prodotti ordinati per Codice

Part Number	Type Number	Replacement/Remplacé par Ersatz / Sostituito da	Page	Part Number	Type Number	Replacement/Remplacé par Ersatz / Sostituito da	Page
K000116	SB6558	¹⁾	167	K000260M1	SB7902	¹⁾ K000260 (SB7902)	168
K000116AT	–	¹⁾	167	K000261	SB7912	²⁾	168
K000136	SB7900	¹⁾	167	K000261AT	–	¹⁾	168
K000136AT	–	¹⁾	168	K000261IV	–	²⁾	168
K000137	SB7910	¹⁾	168	K000261M1	SB7912	¹⁾ K000261 (SB7912)	168
K000137AT	–	¹⁾	168	K000262	SB7189	¹⁾	168
K000138	SB7901	¹⁾	168	K000263	SB7199	¹⁾	168
K000139	SB7911	¹⁾	168	K000264	SV1490		198
K000166	SB7188	¹⁾	168	K000266	SN7045	¹⁾	168
K000167	SB7198	¹⁾	168	K000267	SN7055	¹⁾	168
K000173	KU1411	²⁾ K000955 (KU1411)	67	K000281	SN5001	¹⁾	168
K000174	KU1401	¹⁾ K000953 (KU1401)	67	K000282	SN5011	¹⁾	168
K000202	SN7020	¹⁾	168	K000300	SB6567	¹⁾	168
K000203	SN7030	¹⁾	168	K000301	SB6577	¹⁾	168
K000204	SN7020	¹⁾	168	K000302	SN7022	¹⁾	168
K000205	SN7030	¹⁾	168	K000303	SN7032	¹⁾	168
K000206	SN7022	¹⁾	168	K000304	SN7022	¹⁾	168
K000207	SN7032	¹⁾	168	K000305	SN7032	¹⁾	168
K000208	SN7022	¹⁾	168	K000306	SN7020	¹⁾	168
K000209	SN7032	¹⁾	168	K000306AT	–	¹⁾	168
K000210	SB6566	¹⁾	168	K000307	SN7030	¹⁾	168
K000210AT	–	¹⁾ K001080DC	169	K000307AT	–	¹⁾	168
K000211	SB6576	¹⁾	168	K000308	SN7020	¹⁾	168
K000211AT	–	¹⁾ K001079DC	169	K000308AT	–	¹⁾ K000306AT	168
K000212	SB6566	¹⁾	168	K000309	SN7030	¹⁾	168
K000213	SB6576	¹⁾	168	K000309AT	–	¹⁾ K000307AT	168
K000229	LP4985	²⁾ K000229000 (LP4985)	16	K000310	SB7648	¹⁾ K000306 (SN7020)	168
K000229000	LP4985		16	K000311	SB7658	¹⁾ K000307 (SN7030)	168
K000230	LK4918	¹⁾ K001267000 (LK4918)	15	K000312	SB7648	¹⁾ K000308 (SN7020)	168
K000231	LK4919	¹⁾ K002029000 (LK4919)	15	K000313	SB7658	¹⁾ K000309 (SN7030)	168
K000232	LK4920	¹⁾ K002032000 (LK4920)	15	K000314	SB7649	¹⁾ K000302 (SN7022)	168
K000233	LK4921	²⁾ K001268000 (LK4921)	15	K000315	SB7659	¹⁾ K000303 (SN7032)	168
K000235	LP4992	¹⁾ K002031000 (LP4992)	16	K000316	SB7649	¹⁾ K000304 (SN7022)	168
K000236	LP4974	²⁾ K000236000 (LP4974)	16	K000317	SB7659	¹⁾ K000305 (SN7032)	168
K000236000	LP4974		16	K000320	SB7904	¹⁾	168
K000237	LP4960	²⁾ K000237000 (LP4960)	16	K000321	SB7914	¹⁾	168
K000237000	LP4960		16	K000322	SB6521	¹⁾	168
K000258	SB7200	¹⁾	168	K000323	SB6531	¹⁾	168
K000258AT	–	¹⁾	168	K000336	LA8289		22
K000258SAT	–	¹⁾ K000258SC	168	K000367	SV1485		198
K000258SC	–	¹⁾	168	K000368	–	¹⁾ Z000723AT	180
K000259	SB7210	¹⁾	168	K000369	–	¹⁾ Z000724AT	180
K000259AT	–	¹⁾	168	K000378	SB7607	¹⁾	168
K000259SAT	–	¹⁾ K000259SC	168	K000379	SB7617	¹⁾	168
K000259SC	–	¹⁾	168	K000386	SB7880	¹⁾	168
K000260	SB7902	²⁾	168	K000386AT	–	¹⁾	168
K000260AT	–	¹⁾	168	K000387	SB7890	¹⁾	168
K000260IV	–	²⁾	168	K000387AT	–	¹⁾	168

Products in Part Number order
Produkte, nach Teilenummern geordnet

Classification des Produits par Numero
Prodotti ordinati per Codice

Part Number	Type Number	Replacement/Remplacé par Ersatz / Sostituito da	Page	Part Number	Type Number	Replacement/Remplacé par Ersatz / Sostituito da	Page
K000390	LA8130	²⁾ K000390N00 (LA8130)	20, 23	K000550	SB7901	¹⁾	169
K000390N00	LA8130		20, 23	K000551	SB7911	¹⁾	169
K000391	LA8131	²⁾ K000391N00 (LA8131)	20, 23	K000552	SB7909	¹⁾	169
K000391N00	LA8131		20, 23	K000553	SB7919	¹⁾	169
K000392	LA8132	²⁾ K000392N00 (LA8132)	20, 23	K000584	SB6582	¹⁾	169
K000392N00	LA8132		20, 23	K000584AT	–	¹⁾	169
K000394	ZB4578	²⁾ K000394N00 (ZB4578)	23	K000585	SB6592	¹⁾	169
K000394N00	ZB4578		23	K000585AT	–	¹⁾	169
K000395	ZB4579	²⁾ K000395N00 (ZB4579)	23	K000605	SN7046	²⁾	169
K000395N00	ZB4579		23	K000606	SN7056	²⁾	169
K000396	ZB4580	²⁾ K000396N00 (ZB4580)	23	K000613	DR4150		37
K000396N00	ZB4580		23	K000615	DR4151		37
K000411	VG3283		209	K000616	DR4153		37
K000412	SB7906		168	K000618	DR4155		37
K000412AT	–	¹⁾	168	K000619	DR4156		37
K000412IV	–	²⁾	168	K000622	DR4159		38
K000413	SB7916		168	K000624	DR4250		38
K000413AT	–	¹⁾	168	K000626	DR4252		38
K000413IV	–	²⁾	168	K000627	DR4253		38
K000445	SN7029	¹⁾	168	K000630	DR4256		38
K000446	SN7039	¹⁾	168	K000632	DR4258		38
K000447	SN7029	¹⁾	168	K000634	DR4260		38
K000448	SN7039	¹⁾	168	K000636	DR4370		38
K000449	SN7029	¹⁾	168	K000638	DR4372		38
K000450	SN7039	¹⁾	168	K000639	DR4373		38
K000469	–	¹⁾	232	K000641	DR4375		38
K000474	SN7066	¹⁾	168	K000642	DR4376		38
K000475	SN7076	¹⁾	168	K000643	DR4377		38
K000476	SN7067	¹⁾	168	K000644	DR4378		38
K000477	SN7077	¹⁾	168	K000645	DR4379		38
K000479	LA8008		19	K000647	DR4381		38
K000485	SB7201	¹⁾	168	K000649	DR4383		38
K000485AT	–	¹⁾	168	K000651	DR4385		38
K000486	SB7211	¹⁾	168	K000661	SV1491		198
K000486AT	–	¹⁾	168	K000699	BS8452		146
K000487	SB7621	¹⁾	168	K000700	BS8453		146
K000487AT	–	¹⁾	168	K000701	AE7110		192
K000488	SB7631	¹⁾	168	K000715	SN6508	¹⁾	169
K000488AT	–	¹⁾	168	K000716	SN6518	¹⁾	169
K000500	AE4623		41	K000719	SB7762	¹⁾	169
K000510	–	¹⁾ K000810	184	K000719AT	–	¹⁾	169
K000511	VG3284		209	K000720	SB7772	¹⁾	169
K000513	LK4932		15	K000720AT	–	¹⁾	169
K000516	AE4625		41	K000740	LK3947	²⁾ K040432N00 (LK3947)	12
K000517	SB7903	¹⁾	168	K000741	LK3959		12
K000517AT	–	¹⁾	169	K000742	LK3985	²⁾ K000741 (LK3959)	12
K000518	SB7913	¹⁾	169	K000745	EE4107		31
K000518AT	–	¹⁾	169	K000754	LA8063	²⁾ K000754N00 (LA8063)	20

Products in Part Number order
Produkte, nach Teilenummern geordnet

Classification des Produits par Numero
Prodotti ordinati per Codice

Part Number	Type Number	Replacement/Remplacé par Ersatz / Sostituito da	Page	Part Number	Type Number	Replacement/Remplacé par Ersatz / Sostituito da	Page
K000754N00	LA8063		20	K000871AT	–	¹⁾	169
K000755	LA8064	²⁾ K000755N00 (LA8064)	20	K000872	SN7085	¹⁾	169
K000755N00	LA8064		20	K000873	SN7095	¹⁾	169
K000755R	LA8064	²⁾ K000755N00 (LA8064)	20	K000909	BS9362		148
K000771	SN7047	¹⁾	169	K000910	BS9363		148
K000772	SN7057	¹⁾	169	K000913N50	–	²⁾ K021204N50	96
K000773	SN7047	¹⁾	169	K000914N50	–	²⁾ K021203N50	96
K000774	SN7057	¹⁾	169	K000917100	–	²⁾ K020623N50	100
K000775	SN7048	¹⁾	169	K000917N50	–	²⁾ K020623N50	100
K000776	SN7058	¹⁾	169	K000918N50	–	²⁾ K020624N50	100
K000778	SN7049	¹⁾	169	K000921	–	²⁾ K000921N50	97
K000779	SN7059	¹⁾	169	K000921N50	–		97
K000780	SN7080	¹⁾	169	K000922	–	²⁾ K000922N50	97
K000781	SN7090	¹⁾	169	K000922N50	–		97
K000782	SN7081	¹⁾	169	K000923	–	²⁾ K023215N50	97
K000782AT	–	¹⁾	169	K000926	–	²⁾ K039569N50	99
K000783	SN7091	¹⁾	169	K000928	–	²⁾ K040159N50	99
K000783AT	–	¹⁾	169	K000952	KU1400		67
K000786	SN7083	¹⁾	169	K000953	KU1401		67
K000786AT	SN7083	¹⁾ K003249AT	172	K000954	KU1410		67
K000787	SN7093	¹⁾	169	K000955	KU1411		67
K000787AT	SN7093	¹⁾ K003250AT	172	K000956	KU1412		67
K000790	SN7028	¹⁾	169	K000976	BS8316		145
K000791	SN7038	¹⁾	169	K000977	BS8317		145
K000810	–		184	K000978	BS9265		147
K000815	SB7766	¹⁾	169	K000978000	BS9265	¹⁾ K000978 (BS9265)	147
K000815AT	–	²⁾	169	K000979	BS9266		147
K000816	SB7776	¹⁾	169	K000979000	BS9266	¹⁾ K000979 (BS9266)	147
K000816AT	–	²⁾	169	K000993	SN7086	¹⁾	169
K000821000	LP4857	²⁾ K022249N00 (LP4857)	16	K000994	SN7096	¹⁾	169
K000822	SB7929	¹⁾	169	K001027	BS2514	²⁾ K002843 (BS2514)	132
K000823	SB7939	¹⁾	169	K001028	BS2515	²⁾ K002844 (BS2515)	132
K000826	SB7940		169	K001029	BS9086	¹⁾ K007629 (BS9086)	147
K000827	SB7950		169	K001030	BS9087	¹⁾ K007630 (BS9087)	147
K000830	SB7766	²⁾	169	K001031	BS8413	¹⁾ K007668 (BS8413)	146
K000831	SB7776	²⁾	169	K001032	BS8414	²⁾ K007669 (BS8414)	146
K000849	SN7042	¹⁾	169	K001038	SN7101	¹⁾	169
K000850	SN7052	¹⁾	169	K001039	SN7111	¹⁾	169
K000851	SN7066	²⁾	169	K001041	AE4535	²⁾	40
K000852	SN7076	²⁾	169	K001043	DB2116		63
K000853000	LK3839	¹⁾ K008457000 (LK3875)	12	K001044	DB2122		63
K000855	LP3977	¹⁾ K014799000 (LP3977)	13	K001047	DB2116		63
K000855000	LP3977	¹⁾ K014799000 (LP3977)	13	K001051	SN7102	¹⁾	169
K000861	LK3846	²⁾ K000861000 (LK3846)	12	K001051AT	–	¹⁾	169
K000861000	LK3846		12	K001052	SN7112	¹⁾	169
K000870	SN7084	¹⁾	169	K001052AT	–	¹⁾	169
K000870AT	–	¹⁾	169	K001054	SB6584	¹⁾	169
K000871	SN7094	¹⁾	169	K001055	SB6594	¹⁾	169

Products in Part Number order
Produkte, nach Teilenummern geordnet

Classification des Produits par Numero
Prodotti ordinati per Codice

Part Number	Type Number	Replacement/Remplacé par Ersatz / Sostituito da	Page	Part Number	Type Number	Replacement/Remplacé par Ersatz / Sostituito da	Page
K001056	LA8065	²⁾ K001056N00 (LA8065)	20	K001177	SN6541	¹⁾	170
K001056N00	LA8065		20	K001177DC	–	¹⁾	170
K001056R	LA8065	²⁾ K001056N00 (LA8065)	20	K001178	SN6551	¹⁾	170
K001057	BY9276		142	K001178DC	–	¹⁾	170
K001059	BY9331	¹⁾ K014030 (BY9331)	143	K001197	LA8066	²⁾ II19335N00 (LA8004)	19
K001071	VG3285		209	K001207000	LK4935	¹⁾ K002135 (LA8068)	20
K001076	LA9013	²⁾ K024486 (LA9013)	22	K001214	BS3471		134
K001077	SN7104	²⁾	169	K001215	BS3472		134
K001078	SN7114	²⁾	169	K001216DC	–	²⁾	170
K001079	SN6527	²⁾	169	K001225	SN7121	¹⁾	170
K001079DC	–	²⁾	169	K001226	SN7131	¹⁾	170
K001080	SN6537	²⁾	169	K001228	SB7942	¹⁾	170
K001080DC	–	²⁾	169	K001229	SB7952	¹⁾	170
K001081	SN6527		169	K001232	SN7122	¹⁾	170
K001082	SN6537		169	K001233	SN7132	¹⁾	170
K001083	SN6527	¹⁾	169	K001238	BS8415	²⁾ K007670 (BS8415)	146
K001084	SN6537	¹⁾	169	K001245	SV1493		198
K001085	SN6527		169	K001267	LK4918	²⁾ K001267000 (LK4918)	15
K001086	SN6537		169	K001267000	LK4918		15
K001087	SN6528	¹⁾	169	K001268	LK4921	²⁾ K001268000 (LK4921)	15
K001088	SN6538	¹⁾	169	K001268000	LK4921		15
K001089	SN6528	¹⁾	169	K001282	LK3866	¹⁾ K018385 (LK3866)	12
K001090	SN6538	¹⁾	169	K001288	–	¹⁾	232
K001091	SN6528	¹⁾	169	K001289	SN7123	¹⁾	170
K001092	SN6538	¹⁾	170	K001290	SN7133	¹⁾	170
K001093	SN6528	¹⁾	170	K001291	SN7124	¹⁾	170
K001094	SN6538	¹⁾	170	K001292	SN7134	¹⁾	170
K001115	SN7105	¹⁾	170	K001312	SN7125	¹⁾	170
K001116	SN7115	¹⁾	170	K001313	SN7135	¹⁾	170
K001117	SN6529	¹⁾	170	K001314	SN7126	¹⁾	170
K001118	SN6539	¹⁾	170	K001315	SN7136	¹⁾	170
K001123	BS8420	¹⁾ K007657 (BS8420)	146	K001316	SN7127	¹⁾	170
K001124	BS8421	¹⁾ K007658 (BS8421)	146	K001317	SN7137	¹⁾	170
K001126	LK4936	²⁾ K001126000 (LK4936)	15	K001319N00	–		203
K001126000	LK4936		15	K001338	SN6542	²⁾	170
K001127	LK4937	²⁾ K001127000 (LK4937)	15	K001339	SN6552	²⁾	170
K001127000	LK4937		15	K001340	SN6543	¹⁾	170
K001140	SN7106	¹⁾	170	K001341	SN6553	¹⁾	170
K001141	SN7116	¹⁾	170	K001349	AE5131		70
K001142	SN7106	¹⁾	170	K001352	SB7943	¹⁾ K001225 (SN7121)	170
K001143	SN7116	¹⁾	170	K001353	SB7953	¹⁾ K001226 (SN7131)	170
K001164	SN7107	¹⁾	170	K001362	SB7948	¹⁾	170
K001164AT	–	¹⁾	170	K001362AT	–	¹⁾	170
K001165	SN7117	¹⁾	170	K001363	SB7958	¹⁾	170
K001165AT	–	¹⁾	170	K001363AT	–	¹⁾	170
K001170	SN7118	¹⁾	170	K001364	SB7948	¹⁾	170
K001175	SN6541	¹⁾	170	K001364AT	–	¹⁾	170
K001176	SN6551	¹⁾	170	K001365	SB7958	¹⁾	170

Products in Part Number order
Produkte, nach Teilenummern geordnet

Classification des Produits par Numero
Prodotti ordinati per Codice

Part Number	Type Number	Replacement/Remplacé par Ersatz / Sostituito da	Page	Part Number	Type Number	Replacement/Remplacé par Ersatz / Sostituito da	Page
K001365AT	–	¹⁾	170	K001556	EZ1031	¹⁾ II39809F (EZ1031)	124
K001370	SN7129	¹⁾	170	K001589	SB7202	¹⁾	170
K001371	SN7139	¹⁾	170	K001589M2	SB7202	¹⁾ K001589 (SB7202)	170
K001371M1	SN7139	¹⁾ K001371 (SN7139)	170	K001589SC	–	¹⁾	170
K001372	SN7140	¹⁾	170	K001590	SB7212	¹⁾	170
K001373	SN7150	¹⁾	170	K001590M2	SB7202	¹⁾ K001590 (SB7212)	170
K001373M1	SN7150	¹⁾ K001373 (SN7150)	170	K001590SC	–	¹⁾	170
K001374	SN7141	¹⁾	170	K001591	SB7189	¹⁾	171
K001375	SN7151	¹⁾	170	K001591SC	–	¹⁾	171
K001411	–	²⁾ K000922N50	97	K001592	SB7199	¹⁾	171
K001411R	–	²⁾ K000922N50	97	K001592SC	–	¹⁾	171
K001413	SN7142	¹⁾	170	K001593	SB7203	¹⁾	171
K001414	SN7152	¹⁾	170	K001593M2	SB7203	¹⁾ K001593 (SB7203)	170
K001419	SN7081	¹⁾	170	K001594	SB7213	¹⁾	171
K001420	SN7091	¹⁾	170	K001603	BS2516	²⁾ K006655N00 (BS2523)	132
K001421	SN7081	¹⁾	170	K001604	BS2517	²⁾ K006656N00 (BS2524)	132
K001422	SN7091	¹⁾	170	K001605	BS8540	¹⁾ K007135000 (BS8507)	146
K001428	–	²⁾ K040158N50	99	K001606	BS8541	¹⁾ K007136000 (BS8508)	147
K001436	BS9083	²⁾ K007631 (BS9083)	147	K001654	SN7041	¹⁾	171
K001437	BS9084	¹⁾ K007631 (BS9083)	147	K001654SC	–	¹⁾	171
K001440	SN6545	²⁾	170	K001655	SN7051	¹⁾	171
K001441	SN6555	²⁾	170	K001655SC	–	¹⁾	171
K001442	SN6546	¹⁾	170	K001659	SN7040	¹⁾ K009085 (SN7040)	174
K001443	SN6556	¹⁾	170	K001659SC	–	¹⁾ K003852SC	173
K001444	SN6547	¹⁾	170	K001660	SN7050	¹⁾	171
K001445	SN6557	¹⁾	170	K001660SC	–	¹⁾ K003853SC	173
K001449	ZB4589	²⁾ K001449N00 (ZB4589)	24	K001661	SN7045	¹⁾ K005079 (SN7045)	173
K001449N00	ZB4589		24	K001662	SN7055	¹⁾ K005080 (SN7055)	173
K001450	ZB4590	²⁾ K001450N00 (ZB4590)	24	K001671	LK4934	¹⁾ K015108 (LK4960)	15
K001450N00	ZB4590		24	K001713	BY9278	¹⁾ K014029 (BY9278)	142
K001451	SN7143		170	K001714	BY9279	¹⁾ K014031 (BY9279)	142
K001452	SN7153		170	K001715	BY9367	²⁾	143
K001453	ZB4591	²⁾ K001453N00 (ZB4591)	24	K001728	LK3867	²⁾ K001728000 (LK3867)	12
K001453N00	ZB4591		24	K001728000	LK3867		12
K001457	ZB4595	²⁾ K001457N00 (ZB4595)	24	K001747	SN5002	¹⁾	171
K001457N00	ZB4595		24	K001747DC	–	¹⁾	171
K001458	ZB4596	²⁾ K001458N00 (ZB4596)	24	K001748	SN5012	¹⁾	171
K001458N00	ZB4596		24	K001748DC	–	¹⁾	171
K001459	ZB4597	²⁾ K001459N00 (ZB4597)	24	K001749	SN5002	²⁾	171
K001459N00	ZB4597		24	K001750	SN5012	¹⁾	171
K001460	SB7960	¹⁾	170	K001751	SN5003	¹⁾	171
K001461	SB7970	¹⁾	170	K001751DC	–	¹⁾	171
K001475	SN7144	¹⁾	170	K001752	SN5013	¹⁾	171
K001476	SN7154	¹⁾	170	K001752DC	–	¹⁾	171
K001481	SK7026	²⁾	170	K001753	SN5003	¹⁾	171
K001482	SK7036	²⁾	170	K001754	SN5013	¹⁾	171
K001545	SN6507	¹⁾	170	K001761	BS8425	¹⁾ K007130000 (BS8458)	146
K001546	SN6517	¹⁾	170	K001763	SN6504	¹⁾	171

Products in Part Number order
Produkte, nach Teilenummern geordnet

Classification des Produits par Numero
Prodotti ordinati per Codice

Part Number	Type Number	Replacement/Remplacé par Ersatz / Sostituito da	Page	Part Number	Type Number	Replacement/Remplacé par Ersatz / Sostituito da	Page
K001763DC	–	¹⁾ K002059DC	171	K002000	BS9369	²⁾ K010007 (BT4701)	150
K001764	SN6514	¹⁾	171	K002002	BS9370		148
K001764DC	–	¹⁾ K002060DC	171	K002003	BS9371		148
K001765	SN6504	¹⁾	171	K002010	SB7962	¹⁾	171
K001766	SN6514	¹⁾	171	K002011	SB7972	¹⁾	171
K001767	SN6504	¹⁾	171	K002012	SB7963	¹⁾	171
K001767DC	–	¹⁾ K002063DC	171	K002012AT	–	¹⁾	171
K001768	SN6514	¹⁾	171	K002013	SB7973	¹⁾	171
K001768DC	–	¹⁾ K002064DC	171	K002013AT	–	¹⁾	171
K001769	SN6504	¹⁾	171	K002018	SV3240		108, 200
K001770	SN6514	¹⁾	171	K002029	LK4919	²⁾ K002029000 (LK4919)	15
K001885	SV1494	¹⁾ K002336 (SV1494)	198	K002029000	LK4919		15
K001894	–	²⁾ K040156N50	99	K002031	LP4992	²⁾ K002031000 (LP4992)	16
K001899	BS8323		145	K002031000	LP4992		16
K001902	BS9269		147	K002032	LK4920	²⁾ K002032000 (LK4920)	15
K001903	BS9270		147	K002032000	LK4920		15
K001908	SK7001	¹⁾	171	K002045	LP4957	¹⁾ K002975000 (LP4957)	16
K001909	SK7011	¹⁾	171	K002046	LP4964	²⁾ K002046000 (LP4964)	16
K001942	SN5001	¹⁾	171	K002046000	LP4964		16
K001943	SN5011	¹⁾	171	K002057	SB7704	¹⁾	171
K001944	SN5001	¹⁾	171	K002058	SB7714	¹⁾	171
K001945	SN5011	¹⁾	171	K002059	SN6550	¹⁾	171
K001946	BS7318	²⁾ K026900N00 (BS7318)	151	K002059DC	–	¹⁾	171
K001947	BS7319	²⁾ K026901N00 (BS7319)	151	K002060	SN6560	¹⁾	171
K001949	SB7205	¹⁾	171	K002060DC	–	¹⁾	171
K001950	SB7215	¹⁾	171	K002061	SN6550	¹⁾	171
K001951	SN7146	²⁾	171	K002061DC	–	¹⁾ K002059DC	171
K001952	SN7156	²⁾	171	K002062	SN6560	¹⁾	171
K001953	SN7147	¹⁾	171	K002062DC	–	¹⁾ K002060DC	171
K001954	SN7157	¹⁾	171	K002063	SN6504	¹⁾	171
K001955	SN6549	¹⁾	171	K002063DC	–	¹⁾	171
K001962	BS7355	²⁾ K026904N00 (BS7355)	151	K002064	SN6514	¹⁾	171
K001963	BS7356	²⁾ K026905N00 (BS7356)	151	K002064DC	–	¹⁾	171
K001970	BS8426	¹⁾ K007677 (BS8426)	146	K002065	SN6504	¹⁾	171
K001971	BS8427	¹⁾ K007678 (BS8427)	146	K002065DC	–	¹⁾ K002063DC	171
K001973	–	²⁾ K044694N50	99	K002066	SN6514	¹⁾	171
K001974	–	²⁾ K024928N50	99	K002066DC	–	¹⁾ K002064DC	171
K001976	BS9283		148	K002097	BS8328	¹⁾ K007655 (BS8328)	145
K001982	ZB4600	²⁾ K001982N00 (ZB4600)	24	K002098	BS8329	¹⁾ K007656 (BS8329)	145
K001982N00	ZB4600		24	K002099	SN7160	¹⁾	171
K001983	ZB4601	²⁾ K001983N00 (ZB4601)	24	K002100	SN7170	¹⁾	171
K001983N00	ZB4601		24	K002107	SN6551	¹⁾	171
K001984	ZB4602	²⁾ K001984N00 (ZB4602)	24	K002108	SN6561	¹⁾	171
K001984N00	ZB4602		24	K002118	SB7901	¹⁾	171
K001985	ZB4603	²⁾ K001985N00 (ZB4603)	24	K002119	SB7911	¹⁾	171
K001985N00	ZB4603		24	K002120	–	²⁾ K002120000 (LK4952)	15
K001998	LK4939		15	K002120000	LK4952		15
K001999	BS9368	²⁾ K010006 (BT4700)	150	K002123	LK4935	²⁾ K002123000 (LK4935)	15

Products in Part Number order
Produkte, nach Teilenummern geordnet

Classification des Produits par Numero
Prodotti ordinati per Codice

Part Number	Type Number	Replacement/Remplacé par Ersatz / Sostituito da	Page	Part Number	Type Number	Replacement/Remplacé par Ersatz / Sostituito da	Page
K002123000	LK4935		15	K002334	SV1351		197
K002135	LA8068		20	K002335	SV1294		197
K002141	LK3840	²⁾ K002141000 (LK3840)	12	K002336	SV1494		198
K002141000	LK3840		12	K002337	SN7022	¹⁾	172
K002142	SB6520	¹⁾	171	K002338	SN7032	¹⁾	172
K002142AT	–	¹⁾	171	K002339	SN7022	¹⁾	172
K002143	SB6530	¹⁾	171	K002340	SN7032	¹⁾	172
K002143AT	–	¹⁾	171	K002341	SN7022	¹⁾	172
K002144	SB7903	¹⁾	171	K002342	SN7032	¹⁾	172
K002145	SB7913	¹⁾	171	K002343	SN7022	¹⁾	172
K002147	AE4629		24	K002344	SN7032	¹⁾	172
K002148N00	LA8136		20, 24	K002345	SN7022	¹⁾	172
K002149N00	ZB4606		24	K002346	SN7032	¹⁾	172
K002163	BY9512		143	K002347	SN7022	¹⁾	172
K002167	SN7163	¹⁾	171	K002348	SN7032	¹⁾	172
K002168	SN7173	¹⁾	171	K002349	SN7021	¹⁾	172
K002171	BY3510		130	K002350	SN7031	¹⁾	172
K002173	VG3286		209	K002351	SN7021	¹⁾	172
K002174	LA8298		22	K002352	SN7031	¹⁾	172
K002183	LK4944	¹⁾ K017527000 (LK4944)	15	K002353	SN7020	¹⁾	172
K002200	BS8430	²⁾ K002200000 (BS8430)	146	K002354	SN7030	¹⁾	172
K002200000	BS8430		146	K002355	SN7020	¹⁾	172
K002201	BS8431	²⁾ K002201000 (BS8431)	146	K002355DC	–	¹⁾	172
K002201000	BS8431		146	K002356	SN7030	¹⁾	172
K002222	SN7165	¹⁾	171	K002356DC	–	¹⁾	172
K002223	SN7175	¹⁾	171	K002357	SN7020	¹⁾	172
K002241	ZB4400		23	K002358	SN7030	¹⁾	172
K002246	SN7164	¹⁾	171	K002359	SN7020	¹⁾	172
K002247	SN7174	¹⁾	171	K002360	SN7030	¹⁾	172
K002270	–		110	K002361	SN7020	¹⁾	172
K002271	–		110	K002362	SN7030	¹⁾	172
K002273	–		110, 118	K002363	SN7020	¹⁾	172
K002274N00	–		91, 110, 118	K002363DC	–	¹⁾	172
K002275N00	–		91, 110, 118	K002364	SN7030	¹⁾	172
K002276N00	–		91, 110, 118	K002364DC	–	¹⁾	172
K002277N00	–		118	K002375	SB7965		172
K002278N00	–		118	K002376	SB7975		172
K002279N00	–		118	K002398	SV1496		198
K002280N00	–		110, 118	K002404	LK3869	¹⁾ K016932 (LK3869)	12
K002281N00	–		110, 118	K002420	BS3532		134
K002285	–		110, 118	K002432	ZB4800	²⁾ K025295N00 (ZB4809)	24
K002287	–	²⁾ K002287N00	111	K002435	AE4800	²⁾ K002435N50 (AE4800)	24, 41
K002287N00	–		111	K002435N50	AE4800		24, 41
K002289	–		116	K002444	SN7167	¹⁾	172
K002290	–		116	K002444AT	–	¹⁾	172
K002291	–		116	K002445	SN7177	¹⁾	172
K002306	SB7964	¹⁾	171	K002445AT	–	¹⁾	172
K002307	SB7974	¹⁾	171	K002446	SN7168	¹⁾	172

Products in Part Number order
Produkte, nach Teilenummern geordnet

Classification des Produits par Numero
Prodotti ordinati per Codice

Part Number	Type Number	Replacement/Remplacé par Ersatz / Sostituito da	Page	Part Number	Type Number	Replacement/Remplacé par Ersatz / Sostituito da	Page
K002446AT	–	¹⁾	172	K002844	BS2515		132
K002447	SN7178	¹⁾	172	K002849	BS3411	²⁾ K004209N00 (BS3411)	133
K002447AT	–	¹⁾ K006433AT	174	K002850	BS3412	²⁾ K004211N00 (BS3412)	133
K002515	SN6552	¹⁾	172	K002851	BS3501	¹⁾ K002623N00 (BS3501)	134
K002516	SN6562	¹⁾	172	K002852	BS3516	²⁾ K002721N00 (BS3516)	134
K002517	SN7183	¹⁾	172	K002853	BS3522	²⁾ K002722N00 (BS3522)	134
K002518	SN7193	¹⁾	172	K002854	BS9306	²⁾ K002854N00 (BS9306)	148
K002519	SB5006	¹⁾	172	K002854N00	BS9306		148
K002520	SB5016	¹⁾	172	K002855	BS9305	²⁾ K002855N00 (BS9305)	148
K002522	SN7169	¹⁾	172	K002855N00	BS9305		148
K002523	SN7179	¹⁾	172	K002856	BS9321	²⁾ K002856N00 (BS9321)	148
K002556	BS2504		132	K002856N00	BS9321		148
K002571	SN7086	¹⁾	172	K002857	BS9320	²⁾ K002857N00 (BS9320)	148
K002572	SN7096	¹⁾	172	K002857N00	BS9320		148
K002575	SN7126	¹⁾	172	K002858	BS9311	²⁾ K002858N00 (BS9311)	148
K002576	SN7136	¹⁾	172	K002858N00	BS9311		148
K002607	BX9551		139	K002859	BS9308	²⁾ K002859N00 (BS9308)	148
K002609	BX9553		139	K002859N00	BS9308		148
K002623	BS3501	²⁾ K002623N00 (BS3501)	134	K002860	BS9412	²⁾ K002860N00 (BS9412)	148
K002623N00	BS3501		134	K002860N00	BS9412		148
K002624	BS3514	²⁾ K002624N00 (BS3514)	134	K002861	BS9411	²⁾ K002874 (SB6400R)	172
K002624N00	BS3514		134	K002861N00	BS9411		148
K002654	SN6529	¹⁾ K003672 (SN6529)	173	K002874	SB6400R	¹⁾	172
K002655	SN6539	¹⁾ K003673 (SN6539)	173	K002875	SB6410R	¹⁾	172
K002656	SB6582	¹⁾ K003668 (SB6582)	173	K002878	SB6404R	¹⁾	172
K002657	SB6592	¹⁾ K003669 (SB6592)	173	K002879	SB6414R	¹⁾	172
K002658	SN7084	¹⁾ K003670 (SN7084)	173	K002915	SB6403R	¹⁾	172
K002659	SN7094	¹⁾ K003671 (SN7094)	173	K002916	SB6413R	¹⁾	172
K002660	SN7102	¹⁾	172	K002934	SN6529	¹⁾	172
K002661	SN7112	¹⁾	172	K002935	SN6539	¹⁾	172
K002720	BS3515	²⁾ K002720N00 (BS3515)	134	K002954	EK3142		119
K002720N00	BS3515		134	K002955	BS8434	²⁾ K007675 (BS8434)	146
K002721	BS3516	²⁾ K002721N00 (BS3516)	134	K002956	BS8435	²⁾ K007676 (BS8435)	146
K002721N00	BS3516		134	K002968	SB7453R	¹⁾	172
K002722	BS3522	²⁾ K002722N00 (BS3522)	134	K002969	SB7463R	¹⁾	172
K002722N00	BS3522		134	K002972	BS9082	²⁾ K007633 (BS9082)	147
K002734	ZB4801	²⁾ K025295N00 (ZB4809)	24	K002975	LP4957	²⁾ K002975000 (LP4957)	16
K002735	ZB4802	²⁾ K025295N00 (ZB4809)	24	K002975000	LP4957		16
K002736	ZB4803	²⁾ K025295N00 (ZB4809)	24	K002983	SN7107	¹⁾	172
K002736N00	ZB4803		24	K002984	SN7117	¹⁾	172
K002739	LA9017	²⁾ K024635N00 (LA9035)	22, 24	K003012	BS3458		134
K002740	LA9018	²⁾ K024635N00 (LA9035)	22, 24	K003013	BS3467		134
K002740N00	LA9018		22	K003020	BS3423		134
K002771	SB7406R	¹⁾	172	K003021	BS3441		134
K002772	SB7416R	¹⁾	172	K003030	BS3354		133
K002783	SB7408R	¹⁾	172	K003031	BS3362		133
K002784	SB7418R	¹⁾	172	K003056	SN6545	²⁾	172
K002843	BS2514		132	K003057	SN6555	²⁾	172

Products in Part Number order
Produkte, nach Teilenummern geordnet

Classification des Produits par Numero
Prodotti ordinati per Codice

Part Number	Type Number	Replacement/Remplacé par Ersatz / Sostituito da	Page	Part Number	Type Number	Replacement/Remplacé par Ersatz / Sostituito da	Page
K003084000	LP3955	¹⁾	13	K003677	BS9180	¹⁾ K007641 (BS9180)	147
K003084X00	LP3955	²⁾ K003084000 (LP3955)	13	K003678	BS9272	¹⁾ K007644 (BS9272)	147
K003089	–		197	K003679	BS9273	¹⁾ K007645 (BS9273)	148
K003090	–		197	K003715	SN6541	¹⁾	173
K003096	–		197	K003715DC		¹⁾	173
K003165	DB2122		63	K003716	SN6551	¹⁾	173
K003170	BS3538		134	K003716DC		¹⁾	173
K003249AT		²⁾	172	K003717	SN6541	¹⁾	173
K003250AT		²⁾	172	K003717DC		¹⁾	173
K003301	SN5001	¹⁾	172	K003718	SN6551	¹⁾	173
K003302	SN5011	¹⁾	172	K003718DC		¹⁾	173
K003312	SN7166	¹⁾	172	K003791	SN6557R		173
K003313	SN7176	¹⁾	172	K003792	SN6567R		173
K003346	SN7081	¹⁾	172	K003793	SN6558R		173
K003347	SN7091	¹⁾	172	K003794	SN6568R		173
K003348	SN7081	¹⁾	172	K003801	SN7202R	¹⁾	173
K003349	SN7091	¹⁾	172	K003802	SN7212R	¹⁾	173
K003350	SN7081	¹⁾	172	K003830	SN7104	²⁾	173
K003350AT		¹⁾	173	K003831	SN7114	²⁾	173
K003351	SN7091	¹⁾	173	K003833	–		136
K003351AT		¹⁾	173	K003840	BS3313		133
K003352	SN7059	²⁾	173	K003841	BS3332		133
K003353	SN7049	²⁾	173	K003845	BY9233	²⁾ K003845000 (BY9233)	142
K003386	SB7423R	¹⁾	173	K003845000	BY9233		142
K003387	SB7433R	¹⁾	173	K003847	BY9235	²⁾ K003847000 (BY9235)	142
K003400	SK7002	¹⁾	173	K003847000	BY9235		142
K003401	SK7012	¹⁾	173	K003848	–		111
K003402	SK7003	¹⁾	173	K003849	SB7208	¹⁾	173
K003403	SK7013	¹⁾	173	K003850	SB7218	¹⁾	173
K003453	SK7004	¹⁾	173	K003852	SN7040	¹⁾	173
K003454	SK7014	¹⁾	173	K003852SC		²⁾	173
K003455	SB7206	²⁾	173	K003853	SN7050	¹⁾	173
K003456	SB7216	²⁾	173	K003853SC		²⁾	173
K003662	SN6507	¹⁾	173	K003856	SN6569	²⁾	173
K003662AT		¹⁾	173	K003857	SN6579	²⁾	173
K003663	SN6517	¹⁾	173	K003860	SB7209	¹⁾	173
K003663AT		¹⁾	173	K003861	SB7219	¹⁾	173
K003664	SN7164	¹⁾	173	K003865	BY9236	²⁾ K003865000 (BY9236)	142
K003665	SN7174	¹⁾	173	K003865000	BY9236		142
K003666	SN7102	¹⁾	173	K003868	BY9237	²⁾ K003868000 (BY9237)	142
K003667	SN7112	¹⁾	173	K003868000	BY9237		142
K003668	SB6582	¹⁾	173	K003869	BY9238	²⁾ K003869000 (BY9238)	142
K003669	SB6592	¹⁾	173	K003869000	BY9238		142
K003670	SN7084	¹⁾	173	K003924	BY9368		143
K003671	SN7094	¹⁾	173	K003924000	BY9368	²⁾ K003924 (BY9368)	143
K003672	SN6529	¹⁾	173	K003964	BY9322	²⁾ K003964N00 (BY9322)	144
K003673	SN6539	¹⁾	173	K003964N00	BY9322		144
K003676	BS9179	¹⁾ K007640 (BS9179)	147	K003968	BS3250	²⁾ K003968N00 (BS3250)	133

Products in Part Number order
Produkte, nach Teilenummern geordnet

Classification des Produits par Numero
Prodotti ordinati per Codice

Part Number	Type Number	Replacement/Remplacé par Ersatz / Sostituito da	Page
K003968N00	BS3250		133
K003969	BS3273	²⁾ K004286N00 (BS3273)	133
K003991	BS3401	¹⁾ K004171N00 (BS3401)	133
K003992	BS3409	²⁾ K004172N00 (BS3409)	133
K003993	BS3410	²⁾ K004207N00 (BS3410)	133
K003994	BS3413	²⁾ K003994N00 (BS3413)	133
K003994N00	BS3413		133
K003995	BS3414	²⁾ K003995N00 (BS3414)	133
K003995N00	BS3414		133
K003996	BS3514	²⁾ K003996N00 (BS3514)	134
K003996N00	BS3514		134
K003997	BS3515	²⁾ K003997N00 (BS3515)	134
K003997N00	BS3515		134
K004017	BS9253	²⁾ K004017N00 (BS9253)	147
K004017N00	BS9253		147
K004031	BS9491	²⁾ K004031000 (BS9491)	149
K004031000	BS9491		149
K004032	BS9492	²⁾ K004032000 (BS9492)	149
K004032000	BS9492		149
K004033	BS9405	²⁾ K004033N00 (BS9405)	148
K004033N00	BS9405		148
K004034	BS9406	²⁾ K004034N00 (BS9406)	148
K004034N00	BS9406		148
K004040	BS9480	²⁾ K004040N00 (BS9480)	149
K004040N00	BS9480		149
K004041	BS9481	²⁾ K004041N00 (BS9481)	149
K004041N00	BS9481		149
K004042	BS9437	²⁾ K004042N00 (BS9437)	149
K004042N00	BS9437		149
K004043	BS9438	²⁾ K004043N00 (BS9438)	149
K004043N00	BS9438		149
K004044	BS8402	²⁾ K004044000 (BS8402)	146
K004044000	BS8402		146
K004045	BS8403	²⁾ K004045000 (BS8403)	146
K004045000	BS8403		146
K004046	BS9507	²⁾ K004046N00 (BS9507)	149
K004046N00	BS9507		149
K004047	BS9514	²⁾ K004047N00 (BS9514)	149
K004047N00	BS9514		149
K004050	BS9500	²⁾ K004050000 (BS9500)	149
K004050000	BS9500		149
K004051	BS9508	²⁾ K004051000 (BS9508)	149
K004051000	BS9508		149
K004052	BS9502	²⁾ K004052N00 (BS9502)	149
K004052N00	BS9502		149
K004053	BS9509	²⁾ K004053000 (BS9509)	149
K004053000	BS9509		149
K004056	BY9223	²⁾	144

Part Number	Type Number	Replacement/Remplacé par Ersatz / Sostituito da	Page
K004057	BY9224	²⁾	144
K004058	BY9227	²⁾	144
K004059	BY9228	²⁾	144
K004064	BY9323	²⁾ K004064N00 (BY9323)	144
K004064N00	BY9323		144
K004074	BS9476		149
K004075	BS9478		149
K004077	BY9239		142
K004098N00	EK3150		116
K004146	BS3301	²⁾ K004152 (KU4128)	67
K004146N00	BS3301		133
K004152	KU4128		67
K004161	SN6529		173
K004162	SN6539		173
K004171	BS3401	²⁾ K004171N00 (BS3401)	133
K004171N00	BS3401		133
K004172	BS3409	²⁾ K004172N00 (BS3409)	133
K004172N00	BS3409		133
K004207	BS3410	²⁾ K004207N00 (BS3410)	133
K004207N00	BS3410		133
K004208	BS3411	²⁾ K004209N00 (BS3411)	133
K004209	BS3411	²⁾ K004209N00 (BS3411)	133
K004209N00	BS3411		133
K004211	BS3412	²⁾ K004211N00 (BS3412)	133
K004211N00	BS3412		133
K004229	KU4124		67
K004230	KU4128		67
K004231	KU4124		67
K004236	ES1305		89, 92
K004243	ES1302	²⁾	92
K004246	ES1305		89, 92
K004276	SN7022	¹⁾	173
K004277	SN7032	¹⁾	173
K004278	SN7022	¹⁾	173
K004279	SN7032	¹⁾	173
K004286	BS3273	²⁾ K004286N00 (BS3273)	133
K004286N00	BS3273		133
K004295	VG3287		209
K004296	VG3288		209
K004297	VG3289		209
K004330	BY3359	²⁾	130
K004481	SB6585	²⁾	173
K004482	SB6595	²⁾	173
K004483	SB6586	¹⁾	173
K004484	SB6596	¹⁾	173
K004485	BS3434	²⁾ K004485N00 (BS3434)	134
K004485N00	BS3434		134
K004486	BS3435	²⁾ K004486N00 (BS3435)	134

Products in Part Number order
Produkte, nach Teilenummern geordnet

Classification des Produits par Numero
Prodotti ordinati per Codice

Part Number	Type Number	Replacement/Remplacé par Ersatz / Sostituito da	Page	Part Number	Type Number	Replacement/Remplacé par Ersatz / Sostituito da	Page
K004486N00	BS3435		134	K004997	ZB4402		23
K004489	LP3980	²⁾ K015948 (LP3997)	13	K005020	SN7229	¹⁾	174
K004496	SN7227	¹⁾	173	K005021	SN7239	¹⁾	174
K004497	SN7237	¹⁾	173	K005037	SN7240	¹⁾	174
K004526	SN6507	¹⁾	173	K005038	SN7250	¹⁾	174
K004527	SN6517	¹⁾	173	K005059	BS8544	²⁾ K007684 (BS8544)	147
K004545	SN7228	¹⁾	173	K005060	BS8545	²⁾ K007685 (BS8545)	147
K004546	SN7238	¹⁾	173	K005072	–		184
K004547	SN7229	¹⁾	173	K005077	SN7041	¹⁾	174
K004548	SN7239	¹⁾	173	K005078	SN7051	¹⁾	174
K004549	SN7240	¹⁾	173	K005079	SN7045	¹⁾	174
K004550	SN7250	¹⁾	173	K005080	SN7055	¹⁾	174
K004564	LA8233		21	K005086	BS3402		133
K004580	SN7242R	¹⁾	173	K005087	BS3403		133
K004581	SN7252R	¹⁾	173	K005161N00	AE1139		75
K004623	SN7042	¹⁾	173	K005211	BS3516	²⁾	134
K004624	SN7052	¹⁾	173	K005212	BS3522	²⁾	134
K004625	SN7066	¹⁾	173	K005280	ZB4403		23
K004626	SN7076	¹⁾	173	K005485	–	²⁾ K024928N50	99
K004640	LK3841	²⁾ K004640X00 (LK3841)	12	K005486	BS8332	²⁾ K007648 (BS8332)	145
K004640X00	LK3841		12	K005487	BS8333	²⁾ K007649 (BS8333)	145
K004641	LP3970	²⁾ K004641000 (LP3970)	13	K005488	BS8334	¹⁾ K007653 (BS8334)	145
K004641000	LP3970		13	K005489	BS8335	¹⁾ K007654 (BS8335)	145
K004674	SK7006	²⁾	173	K005498	–	²⁾ K000922N50	97
K004675	SK7016	²⁾	173	K005500	–		75
K004682	BS8436		146	K005504	SB7424R	¹⁾	174
K004683	BS8437		146	K005505	SB7434R	¹⁾	174
K004692	LA8069		20	K005582N00	BS8548		147
K004733	SN5007		173	K005583N00	BS8549		147
K004734	SN5017		174	K005589	–		197
K004737	BS3281	²⁾ K004737N00 (BS3281)	133	K005590	–		197
K004737N00	BS3281		133	K005591	–		197
K004758	SN6574	¹⁾	174	K005592	–		197
K004759	SN6584	¹⁾	174	K005594	–		184
K004763	BS2409	²⁾ K018199 (BS2409)	132	K005686	–	²⁾ K039453	30
K004764	BS2410	²⁾ K018200 (BS2410)	132	K005713	SB7766	¹⁾	174
K004789			232	K005714	SB7776	¹⁾	174
K004804	SN7228	¹⁾	174	K005757	SN7247	¹⁾	174
K004805	SN7238	¹⁾	174	K005758	SN7257	¹⁾	174
K004829	–	²⁾ K015965 (LK4928)	15	K005759	SN7247	¹⁾	174
K004852	LK3872	²⁾ K004852000 (LK3872)	12	K005760	SN7257	¹⁾	174
K004852000	LK3872		12	K005814	BS3436		134
K004854	SN7229	¹⁾	174	K005817	BS3547		134
K004855	SN7239	¹⁾	174	K005934	–		197
K004876	BS8330	²⁾ K004876N00 (BS8330)	145	K005935	–		197
K004876N00	BS8330		145	K005938	–		184
K004877	BS8331	²⁾ K004877N00 (BS8331)	145	K005968	SN6500	¹⁾	174
K004877N00	BS8331		145	K005969	SN6510	¹⁾	174

Products in Part Number order
Produkte, nach Teilenummern geordnet

Classification des Produits par Numero
Prodotti ordinati per Codice

Part Number	Type Number	Replacement/Remplacé par Ersatz / Sostituito da	Page	Part Number	Type Number	Replacement/Remplacé par Ersatz / Sostituito da	Page
K005970	SN6509	²⁾	174	K006872	SN7249	¹⁾	174
K005971	SN6519	²⁾	174	K006873	SN7259	¹⁾	174
K005972			232	K006888	–	²⁾ K015875N50	212
K005973		¹⁾	232	K007038	BS9177	²⁾ K007038N00 (BS9177)	147
K005975	–	²⁾ K017062	232	K007038N00	BS9177		147
K005977	LP3986	²⁾	13	K007039	BS9178	²⁾ K007039000 (BS9178)	147
K006066N00	ZB4607		24	K007039000	BS9178		147
K006116	–	²⁾ II40100F	30	K007044	ZB4412		23
K006161	DX61D		48	K007045	BS8337	²⁾ K007045000 (BS8337)	146
K006339	BS3155		132	K007045000	BS8337		146
K006430	SN7167	²⁾	174	K007049	BS8338	²⁾ K007049N00 (BS8338)	146
K006430AT			174	K007049N00	BS8338		146
K006431	SN7177	²⁾	174	K007054	BS9351	²⁾ K007054N00 (BS9351)	148
K006431AT			174	K007054N00	BS9351		148
K006432	SN7168	²⁾	174	K007055	BS9350	²⁾ K007055N00 (BS9350)	148
K006432AT			174	K007055N00	BS9350		148
K006433	SN7178	²⁾	174	K007086	BS9418	²⁾ K007086N00 (BS9418)	148
K006433AT			174	K007086N00	BS9418		148
K006490	BS2503	²⁾ K006490N00 (BS2503)	132	K007087	BS9419	²⁾ K007087N00 (BS9419)	148
K006490N00	BS2503		132	K007087N00	BS9419		148
K006506	BS3212	²⁾ K006506N00 (BS3212)	133	K007088	SN7020	²⁾	174
K006506N00	BS3212		133	K007089	SN7030	²⁾	174
K006507	BS3213	²⁾ K006507N00 (BS3213)	133	K007090	SN7020	¹⁾	174
K006507N00	BS3213		133	K007090DC			174
K006510	BS2306	²⁾ K006510N00 (BS2306)	132	K007091	SN7030	¹⁾	174
K006510N00	BS2306		132	K007091DC			174
K006511	BS2307	²⁾ K006511N00 (BS2307)	132	K007092	SN7020	²⁾	174
K006511N00	BS2307		132	K007093	SN7030	²⁾	174
K006539	SB7220	¹⁾	174	K007094	SN7020	²⁾	174
K006540	SB7230	¹⁾	174	K007095	SN7030	²⁾	174
K006605	SN7248	²⁾	174	K007096	SN7020	²⁾	174
K006606	SN7258	²⁾	174	K007097	SN7030	²⁾	174
K006612	LP4864	²⁾ K033392N00 (LP4864)	16	K007098	SN7020	¹⁾	174
K006613	LP4865	²⁾ K033404N00 (LP4865)	16	K007098DC			174
K006648	BS2429	²⁾ K006648N00 (BS2429)	132	K007099	SN7030	¹⁾	174
K006648N00	BS2429		132	K007099DC			174
K006649	BS2430	²⁾ K006649N00 (BS2430)	133	K007130	BS8458	²⁾ K007130000 (BS8458)	146
K006649N00	BS2430		133	K007130000	BS8458		146
K006653	BS3474	²⁾ K006653N00 (BS3474)	134	K007131	BS8459	²⁾ K007131N00 (BS8459)	146
K006653N00	BS3474		134	K007131N00	BS8459		146
K006654	BS3475	²⁾ K006654N00 (BS3475)	134	K007135	BS8507	²⁾ K007135000 (BS8507)	146
K006654N00	BS3475		134	K007135000	BS8507		146
K006655	BS2523	²⁾ K006655N00 (BS2523)	132	K007136	BS8508	²⁾ K007136000 (BS8508)	147
K006655N00	BS2523		132	K007136000	BS8508		147
K006656	BS2524	²⁾ K006656N00 (BS2524)	132	K007138	BS8460	²⁾ K007138N00 (BS8460)	146
K006656N00	BS2524		132	K007138N00	BS8460		146
K006843	SN6575	²⁾	174	K007139	BS8461	²⁾ K007139N00 (BS8461)	146
K006844	SN6585	²⁾	174	K007139N00	BS8461		146

Products in Part Number order
Produkte, nach Teilenummern geordnet

Classification des Produits par Numero
Prodotti ordinati per Codice

Part Number	Type Number	Replacement/Remplacé par Ersatz / Sostituito da	Page	Part Number	Type Number	Replacement/Remplacé par Ersatz / Sostituito da	Page
K007151	SN7022	¹⁾	174	K007655	BS8328		145
K007152	SN7032	¹⁾	174	K007656	BS8329		145
K007153	SN7022	²⁾	174	K007657	BS8420		146
K007154	SN7032	²⁾	174	K007658	BS8421		146
K007156	SN7032	²⁾	174	K007659	BS9462		149
K007159	SN7022	¹⁾	174	K007661	BS9433		148
K007160	SN7032	¹⁾	174	K007662	BS9434		148
K007187	SN7021		174	K007665	BS9482		149
K007188	SN7031		174	K007666	BS9483		149
K007189	SN7021	²⁾	174	K007668	BS8413		146
K007190	SN7031	²⁾	174	K007669	BS8414		146
K007202	–		111, 118	K007670	BS8415		146
K007205	–		111, 118	K007675	BS8434		146
K007217	–		111	K007676	BS8435		146
K007218	–		111	K007677	BS8426		146
K007219	–		111	K007678	BS8427		146
K007331	EL2201	²⁾	25	K007683	BS9535		149
K007410	AC155P		43	K007684	BS8544		147
K007426	DPM60ND		53	K007685	BS8545		147
K007429	DPM61ND		53	K007765	SN7066	²⁾	174
K007443	DPM90DD	¹⁾ K017049 (DPM90DDX)	54	K007766	SN7076	²⁾	174
K007464	PU1AXYD		49	K007767	SN7042	²⁾	174
K007465	PU1AXYS		49	K007767IV		²⁾	174
K007466	PU3AXYD		49	K007768	SN7052	²⁾	174
K007468	PU3AXYS		49	K007768IV		²⁾	174
K007498	ZB4414		23	K007770	LA8509	²⁾ K007770N00 (LA8509)	22
K007625	BS9092		147	K007770N00	LA8509		22
K007626	BS9093		147	K007771	LA8510	²⁾ K007771N00 (LA8510)	22
K007629	BS9086		147	K007771N00	LA8510		22
K007630	BS9087		147	K007799	BS2437		132
K007631	BS9083		147	K008168	SN7081	²⁾	174
K007632	BS9084		147	K008169	SN7091	²⁾	174
K007632000	BS9084	¹⁾ K007632 (BS9084)	147	K008170	SN7081	²⁾	174
K007633	BS9082		147	K008171	SN7091	²⁾	174
K007640	BS9179		147	K008172	SN7081	²⁾	174
K007641	BS9180		147	K008172DC		²⁾	174
K007642	BS9296		148	K008173	SN7091	²⁾	175
K007642000	BS9296	²⁾ K007642 (BS9296)	148	K008173DC		²⁾	175
K007644	BS9272	²⁾	147	K008340	AC155L		43
K007645	BS9273	²⁾	148	K008415	SB7222	¹⁾	175
K007646	BS9395		148	K008416	SB7232	¹⁾	175
K007646000	BS9395	²⁾ K007646 (BS9395)	148	K008430N00	–		109, 116
K007647	BS9396		148	K008431N00	–		109, 116
K007647000	BS9396	²⁾ K007647 (BS9396)	148	K008432N00	–		109, 116
K007648	BS8332		145	K008433	AC579BK		61
K007649	BS8333		145	K008457	LK3875	²⁾ K008457000 (LK3875)	12
K007653	BS8334		145	K008457000	LK3875		12
K007654	BS8335		145	K008490	AC574AA		61

Products in Part Number order
Produkte, nach Teilenummern geordnet

Classification des Produits par Numero
Prodotti ordinati per Codice

Part Number	Type Number	Replacement/Remplacé par Ersatz / Sostituito da	Page	Part Number	Type Number	Replacement/Remplacé par Ersatz / Sostituito da	Page
K008546	AE1141		108, 206	K009883DC		¹⁾	175
K008649	SB7221	¹⁾	175	K009884	SN6560	¹⁾	175
K008650	SB7231	¹⁾	175	K009884DC		¹⁾	175
K008651	SB7189	¹⁾	175	K009897	SB7202	¹⁾	175
K008652	SB7199	¹⁾	175	K009897SC		¹⁾	175
K008653	SB7202	¹⁾	175	K009898	SB7212	¹⁾	175
K008654	SB7212	¹⁾	175	K009898SC		¹⁾	175
K008766	BS3201		133	K009899	SB7202	¹⁾	175
K008768	BS3207		133	K009900	SB7212	¹⁾	175
K009083	SN7041	¹⁾	175	K009901	SB7221	¹⁾	175
K009084	SN7051	¹⁾	175	K009902	SB7231	¹⁾	175
K009085	SN7040	¹⁾	175	K009903	SB7189	¹⁾	175
K009086	SN7050	¹⁾	175	K009903SC		²⁾	175
K009087	SN7045	¹⁾ K005079 (SN7045)	173	K009904	SB7199	¹⁾	175
K009088	SN7055	¹⁾	175	K009904SC		²⁾	175
K009090N00	CAM1AS		216	K009910	SN6550	¹⁾	175
K009166	EZ1035	²⁾ K009166V02N00 (EZ1035)	109	K009911	SN6560	¹⁾	175
K009166V02N00	EZ1035		109	K009912	SN6504	¹⁾	175
K009258	SN7260	¹⁾	175	K009913	SN6514	¹⁾	175
K009259	SN7270	¹⁾	175	K009914	SN6504	¹⁾	175
K009277	SN7183	¹⁾	175	K009914DC		¹⁾	175
K009278	SN7193	¹⁾	175	K009915	SN6514	¹⁾	175
K009279	SN7084	¹⁾	175	K009915DC		¹⁾	175
K009280	SN7094	¹⁾	175	K009935	PU4AX		49
K009281	SN7164	¹⁾	175	K009936	SC4A		215
K009282	SN7174	¹⁾	175	K009965	SN7263	²⁾	175
K009283	SN7102	¹⁾	175	K009966	SN7273	²⁾	175
K009284	SN7112	¹⁾	175	K009968	BT4800		150
K009286	AC155H		43	K009969	BT4801		150
K009316	SM2AA	²⁾ K044874N00 (SM2PA)	49, 208	K009970	BT5800		150
K009355	ZB4417		23	K009971	BT5801		150
K009363	PU6AX		49	K010002	BT4802		150
K009403	LK4930	²⁾ K009403000 (LK4930)	15	K010003	BT4803		150
K009403000	LK4930		15	K010004	BT4804		150
K009460	-	²⁾ K039454	30	K010005	BT4805		150
K009521	ZB4418	²⁾ K028205 (ZB4418)	23	K010006	BT4700		150
K009534	ZB4420	²⁾ K028206 (ZB4420)	23	K010007	BT4701		150
K009576	DPM90DS	¹⁾ K017050 (DPM90DSX)	54	K010024N00	BS8426		146
K009580	LK4949	²⁾ K009580000 (LK4949)	15	K010025N00	BS8427		146
K009580000	LK4949		15	K010026N00	BS8428		146
K009581	LK4951	²⁾ K009581000 (LK4951)	15	K010027N00	BS8429		146
K009581000	LK4951		15	K010078	DPM90DE		54
K009740	ZB4422		23	K010079	DPM92DE		54
K009744	SK7004	¹⁾	175	K010080	DPM93DE		54
K009745	SK7014	¹⁾	175	K010081	DPM90DEY		54
K009746	SK7001	¹⁾	175	K010114	SN7260	¹⁾	175
K009747	SK7011	¹⁾	175	K010115	SN7270	¹⁾	175
K009883	SN6550	¹⁾	175	K010119	BT5802		150

Products in Part Number order
Produkte, nach Teilenummern geordnet

Classification des Produits par Numero
Prodotti ordinati per Codice

Part Number	Type Number	Replacement/Remplacé par Ersatz / Sostituito da	Page	Part Number	Type Number	Replacement/Remplacé par Ersatz / Sostituito da	Page
K010121	BT5803		150	K010659	SB7232	¹⁾	176
K010147	SN7021	²⁾	175	K010659AT		²⁾	176
K010148	SN7031	²⁾	175	K010666	BS2443	²⁾	132
K010149	SN7022	²⁾	175	K010694	SN5003		176
K010150	SN7032	²⁾	175	K010695	SN5013		176
K010151	SN7022	²⁾	175	K010710N00	–		109, 116
K010152	SN7032	²⁾	175	K010711N00	–		109, 116
K010153	SN7086	¹⁾	175	K010712N00	–		116
K010154	SN7096	¹⁾	175	K010713N00	–		110, 123
K010155	SN7264	¹⁾	175	K010715N00	–		111
K010155SC		²⁾	175	K010716N00	–		111
K010156	SN7274	¹⁾	175	K010717N00	–		116
K010156SC		²⁾	175	K010718N00	–		109, 116
K010164	SB7185	²⁾	175	K010743	SN7322R		176
K010165	SB7195	²⁾	175	K010744	SN7332R		176
K010166	SB7208	²⁾	175	K010749	SN7160	¹⁾	176
K010166AT		²⁾	175	K010750	SN7170	¹⁾	176
K010167	SB7218	²⁾	175	K010791	SN5003	²⁾	176
K010167AT		²⁾	175	K010792	SN5013	²⁾	176
K010168	SB7225	²⁾	175	K010793	SN5002	²⁾	176
K010169	SB7235	²⁾	175	K010794	SN5012	²⁾	176
K010170	SB7942	¹⁾	175	K010837N00	EZ1037		124
K010171	SB7952	¹⁾	175	K010838N00	–		90, 116, 123
K010172	SB7187	²⁾	175	K010849	SM2DK	²⁾ K044873N00 (SM2PD)	49, 50, 208
K010173	SB7197	²⁾	175	K010866	LK4954	¹⁾ K017528 (LK4954)	15
K010198	SC2CK		215	K010897	SN7021		176
K010243	–	²⁾ K039453	30	K010898	SN7031		176
K010274	LA9013	²⁾ K024486 (LA9013)	22	K010899	SN7021	²⁾	176
K010277	SK7007	²⁾	175	K010900	SN7031	²⁾	176
K010277DC		²⁾	175	K010901	SN7021	²⁾	176
K010278	SK7017	²⁾	175	K010902	SN7031	²⁾	176
K010278DC		²⁾	176	K010937	BZ9664		139
K010290	BS3269		133	K010964N00	BS8472		146
K010514	LA9024		22, 23	K010965N00	BS8473		146
K010515	ZB4528		23	K011130	SN7266	²⁾	176
K010558	PU7AX		50	K011131	SN7276	²⁾	176
K010566	BS9563		149	K011132	SN7266	¹⁾	176
K010593	ZB4424		23	K011133	SN7276	¹⁾	176
K010650	SB7509	¹⁾	176	K011134	SN7047	²⁾	176
K010651	SB7519	¹⁾	176	K011135	SN7057	²⁾	176
K010652	SB7201	¹⁾	176	K011136	SN7047	²⁾	176
K010653	SB7211	¹⁾	176	K011137	SN7057	²⁾	176
K010654	SB7209	²⁾	176	K011138	SN7107	²⁾	176
K010655	SB7219	²⁾	176	K011139	SN7117	²⁾	176
K010656	SB7220	¹⁾	176	K011140	SN7107	²⁾	176
K010657	SB7230	¹⁾	176	K011141	SN7117	²⁾	176
K010658	SB7222	¹⁾	176	K011170	SN7085	²⁾	176
K010658AT		²⁾	176	K011171	SN7095	²⁾	176

Products in Part Number order
Produkte, nach Teilenummern geordnet

Classification des Produits par Numero
Prodotti ordinati per Codice

Part Number	Type Number	Replacement/Remplacé par Ersatz / Sostituito da	Page	Part Number	Type Number	Replacement/Remplacé par Ersatz / Sostituito da	Page
K011172	SN7123	²⁾	176	K011311	SB7226	²⁾	177
K011173	SN7133	²⁾	176	K011312	SB7236	²⁾	177
K011174	SN7101	²⁾	176	K011359	BS9251		147
K011175	SN7111	²⁾	176	K011360	BS9252		147
K011176	SN7067	²⁾	176	K011391	SN7168		177
K011177	SN7077	²⁾	176	K011392	SN7178		177
K011178	SN5001	¹⁾	176	K011452	BS9543	²⁾ K011452000 (BS9543)	149
K011179	SN5011	¹⁾	176	K011452000	BS9543		149
K011180	SN5001	²⁾	176	K011453	BS9544		149
K011181	SN5011	²⁾	176	K011481	ZE4601	²⁾	24
K011192	LP3998	²⁾ K040960N00 (LK8905)	13	K011482N00	EL9001		19, 24
K011237	SN5001	²⁾	176	K011537	SN6577		177
K011238	SN5011	²⁾	176	K011538	SN6587		177
K011239	SN5011	²⁾	176	K011539	SN6578		177
K011240	SN5001	²⁾	176	K011540	SN6588		177
K011255	AE4605	²⁾	40	K011541	SN6590	²⁾	177
K011257	SN5013		176	K011542	SN6600	²⁾	177
K011258	SN5003		176	K011545	SK7028		177
K011259	SN5013		176	K011546	SK7038		177
K011259DC		²⁾	176	K011547	SK7029	²⁾	177
K011260	SN5003	²⁾	176	K011548	SK7039	²⁾	177
K011260DC		²⁾	176	K011549	SN5021	²⁾	177
K011261	SN5012	²⁾	176	K011550	SN5031	²⁾	177
K011262	SN5002	²⁾	176	K011551	SN5022		177
K011263	SN5012	²⁾	176	K011552	SN5032		177
K011263DC		²⁾	176	K011666	SN7080	²⁾	177
K011264	SN5002	²⁾	176	K011667	SN7090	²⁾	177
K011264DC		²⁾	176	K011668	SN7122	²⁾	177
K011287	–		219	K011669	SN7132	²⁾	177
K011294	SN7267	²⁾	176	K011670	SN7160	²⁾	177
K011295	SN7277	²⁾	176	K011670AT		²⁾	177
K011296	SN7268		176	K011671	SN7170	²⁾	177
K011297	SN7278		176	K011671AT		²⁾	177
K011298	SN7269	²⁾	176	K011672	SN7249	¹⁾	177
K011298AT		²⁾	176	K011673	SN7259	¹⁾	177
K011299	SN7279	²⁾	176	K011682	BS8510		147
K011299AT		²⁾	176	K011700	SN7284	²⁾	177
K011300	SN7280		176	K011701	SN7294	²⁾	177
K011301	SN7290		176	K011702	SN7285	²⁾	177
K011302	SN7281	²⁾	176	K011703	SN7295	²⁾	177
K011303	SN7291	²⁾	176	K011708	EDP30A		186
K011304	SN7282	²⁾	176	K011796	SN6500	²⁾	177
K011304AT		²⁾	176	K011797	SN6510	²⁾	177
K011305	SN7292	²⁾	176	K011823	ZB4427	²⁾ K028207 (ZB4427)	23
K011305AT		²⁾	177	K011867N00	EL9002		19, 24
K011306	DPM61BAY		53	K011872	SN7087	²⁾	177
K011309	SN7283		177	K011873	SN7097	²⁾	177
K011310	SN7293		177	K011883	DX61E		48

Products in Part Number order
Produkte, nach Teilenummern geordnet

Classification des Produits par Numero
Prodotti ordinati per Codice

Part Number	Type Number	Replacement/Remplacé par Ersatz / Sostituito da	Page	Part Number	Type Number	Replacement/Remplacé par Ersatz / Sostituito da	Page
K011892	DX65D		48	K012342	SK7051	²⁾	177
K011910	-		48	K012343	SN7288	²⁾	177
K011919	-		43	K012344	SN7298	²⁾	177
K011931	AE4502		23, 24, 40	K012345	SN6592	²⁾	177
K011932N50	AE4516		24, 40	K012346	SN6602	²⁾	177
K011981	BY9369		143	K012376N00	BS9429		148
K011982	DX65D		49	K012501	-	²⁾ K012501N00	141
K011984N00	LA8137		20, 24	K012501N00	-		141
K011985N00	LA8138		20, 24	K012502	-	²⁾ K012502N00	141
K011986	ZB4700	²⁾ K011986N00 (ZB4700)	24	K012502N00	-		141
K011986N00	ZB4700		24	K012528	AC155R		44
K011987	ZB4701	²⁾ K011987N00 (ZB4701)	24	K012536	-		184
K011987N00	ZB4701		24	K012576	ZE4501	²⁾	24
K011996	BY9370		143	K012717	BY9372		143
K011997	BY9371		143	K012731	SN6541	¹⁾	177
K012001	SB7227	²⁾	177	K012732	SN6551	¹⁾	177
K012002	SB7237	²⁾	177	K012733	SN6589	¹⁾	177
K012003	SB7227	²⁾	177	K012734	SN6599	¹⁾	177
K012004	SB7237	²⁾	177	K012907	PU4AXYS		49
K012005	SB7228	²⁾	177	K012908	PU4AXYD		49
K012006	SB7238	²⁾	177	K013005	DX60B		48, 49, 50
K012007	SB7228	²⁾	177	K013146	PU4BXYS		49
K012008	SB7238	²⁾	177	K013147	PU4BXYD		49
K012009	SN7287	²⁾	177	K013152	SN6594	²⁾	177
K012010	SN7297	²⁾	177	K013153	SN6604	²⁾	177
K012242	ZB4586	²⁾ K012242N00 (ZB4586)	23	K013154	SN6594	²⁾	177
K012242N00	ZB4586		23	K013155	SN6604	²⁾	177
K012243	ZB4587	²⁾ K012243N00 (ZB4587)	23	K013194	-		91
K012243N00	ZB4587		23	K013203	SN6581R	¹⁾	177
K012244N00	ZB4588		24	K013204	SN6571R	¹⁾	177
K012245	ZB4592	²⁾ K012245N00 (ZB4592)	24	K013218N00	-		121
K012245N00	ZB4592		24	K013328	SN7304	²⁾	177
K012246	ZB4593	²⁾ K012246N00 (ZB4593)	24	K013329	SN7314	²⁾	177
K012246N00	ZB4593		24	K013479	LA8517		22
K012247N00	ZB4594		24	K013569	-		184
K012276	SB7220	¹⁾	177	K013575	-		184
K012276AT		²⁾	177	K013576	SN6596	²⁾	177
K012276SC			177	K013577	SN6606	²⁾	177
K012277	SB7230	¹⁾	177	K013592	SN7108	²⁾	177
K012277AT		²⁾	177	K013593	SN7118	²⁾	177
K012277SC			177	K013661	KU4128		67
K012278	SB7222	¹⁾	177	K013662	KU4124		67
K012278AT		²⁾	177	K013663	KU4128	²⁾ K013661 (KU4128)	67
K012278SC			177	K013727	-	²⁾	212
K012279	SB7232	¹⁾	177	K013739	LK4958		15
K012279AT		²⁾	177	K013741N00	-		205
K012279SC			177	K013763N00	ZB4608		24
K012341	SK7041	²⁾	177	K013764N00	ZB4609		24

Products in Part Number order
Produkte, nach Teilenummern geordnet

Classification des Produits par Numero
Prodotti ordinati per Codice

Part Number	Type Number	Replacement/Remplacé par Ersatz / Sostituito da	Page	Part Number	Type Number	Replacement/Remplacé par Ersatz / Sostituito da	Page
K013765N00	ZB4610		24	K014032	BY9328		143
K013766	ZB4611	²⁾	24	K014032000	BY9328	²⁾ K014032 (BY9328)	143
K013767	LA8140	²⁾	24	K014117	AE1141	²⁾ K035570N00 (AE1141)	206
K013767N00	LA8140		20	K014319N00	LA8144		20, 24
K013768	LA8141	²⁾	24	K014334	SN7029	²⁾	178
K013768N00	LA8141		20	K014335	SN7039	²⁾	178
K013769	LA8142	²⁾	24	K014336	SN7029	²⁾	178
K013769N00	LA8142		20	K014337	SN7039	²⁾	178
K013770	LA8143	²⁾	24	K014338	SN7029	²⁾	178
K013770N00	LA8143		20	K014339	SN7039	²⁾	178
K013772	BS9573		149	K014344	SN7260	¹⁾	178
K013773	BS9574		150	K014345	SN7270	¹⁾	178
K013807	SN7142	²⁾	177	K014371	LK4959		15
K013808	SN7152	²⁾	178	K014371000	LK4959	²⁾ K014371 (LK4959)	15
K013818	SN6551	²⁾	178	K014416	LK4945	²⁾ K026846N01 (LK4968)	15
K013818IV		²⁾	178	K014513	SN6597	²⁾	178
K013819	SN6561	²⁾	178	K014514	SN6607	²⁾	178
K013819IV		²⁾	178	K014516	MB4852		48
K013837	BS8482		146	K014522	SN7307		178
K013838	BS8483		146	K014523	SN7317		178
K013869	SN6546	²⁾	178	K014651	SN7144	²⁾	178
K013870	SN6556	²⁾	178	K014652	SN7154	²⁾	178
K013871	SN6547	¹⁾	178	K014653	SN7144	²⁾	178
K013872	SN6557	¹⁾	178	K014653AT		²⁾	178
K013873	SK7002	²⁾	178	K014654	SN7154	²⁾	178
K013874	SK7012	²⁾	178	K014654AT		²⁾	178
K013879	SN7105	²⁾	178	K014655	SN7169	²⁾	178
K013880	SN7115	²⁾	178	K014655AT		²⁾	178
K013883	SN7106		178	K014656	SN7179	²⁾	178
K013884	SN7116		178	K014656AT		²⁾	178
K013885	SN7129	¹⁾	178	K014658	DR4263		38
K013886	SN7139	¹⁾	178	K014682	ZB4706	²⁾ K014682N00 (ZB4706)	24
K013887	SN7140	¹⁾	178	K014682N00	ZB4706		24
K013888	SN7150	¹⁾	178	K014683	ZB4707	²⁾ K014683N00 (ZB4707)	24
K013889	SN7141	²⁾	178	K014683N00	ZB4707		24
K013890	SN7151	²⁾	178	K014684	ZB4708	²⁾ K014684N00 (ZB4708)	24
K013891	SN7163		178	K014684N00	ZB4708		24
K013892	SN7173		178	K014686	BS8550		147
K013984	MC1D		50, 213	K014687	BS8551		147
K014026	BY9305	²⁾ K014026000 (BY9305)	143	K014688	BS8552		147
K014026000	BY9305		143	K014695	ZB4709	²⁾ K014682N00 (ZB4706)	24
K014027	BY9300	²⁾ K014027000 (BY9300)	142	K014696	ZB4710	²⁾ K014683N00 (ZB4707)	24
K014027000	BY9300		142	K014712	–	¹⁾ K039453	30
K014028	BY9303	²⁾ K014028000 (BY9303)	143	K014774	LK1573		12
K014028000	BY9303		143	K014799	LP3977	²⁾ K014799000 (LP3977)	13
K014029	BY9278		142	K014799000	LP3977		13
K014030	BY9331		143	K014849	AE1141	¹⁾ K015384N00 (AE1141)	108, 206
K014031	BY9279		142	K014896	LK4941	¹⁾ K016615000 (LK4941)	15

Products in Part Number order
Produkte, nach Teilenummern geordnet

Classification des Produits par Numero
Prodotti ordinati per Codice

Part Number	Type Number	Replacement/Remplacé par Ersatz / Sostituito da	Page	Part Number	Type Number	Replacement/Remplacé par Ersatz / Sostituito da	Page
K014919	BS8392		146	K015086	SK7009	¹⁾	178
K014920	BS8393		146	K015087	SK7019	¹⁾	178
K014922	BS9466		149	K015108	LK4960		15
K014923	BS9467		149	K015108000	LK4960	²⁾ K015108 (LK4960)	15
K014935	SN6507	¹⁾	178	K015137	PU7BX		50
K014936	SN6517	¹⁾	178	K015173N00	–		101
K014937	SN6507	¹⁾	178	K015234	SN7080	²⁾	178
K014938	SN6517	¹⁾	178	K015234AT		²⁾	179
K014939	SN6529	¹⁾	178	K015235	SN7090	²⁾	179
K014940	SN6539	¹⁾	178	K015235AT		²⁾	179
K014941	SN6552	¹⁾	178	K015237N00	SM1PLD		49, 208
K014942	SN6562	¹⁾	178	K015309	–	²⁾ K015309N04 (LK4947)	15
K014980	LA8147	²⁾	24	K015309N04	LK4947	²⁾	15
K014980N00	LA8147		20	K015310	MC1A		50, 213
K014981	LA8146	²⁾	24	K015313N00	–		90, 118
K014981N00	LA8146		20	K015380N00	AE4311		77, 108
K014986	LA8145	²⁾	24	K015384N00	AE1141		108, 206
K014986N00	LA8145		20	K015410	LK8901		13
K014987	SN7086	²⁾	178	K015410000	LK8901	²⁾ K015410 (LK8901)	13
K014988	SN7096	²⁾	178	K015425	SN7028	²⁾	179
K014989	SN7127	²⁾	178	K015426	SN7038	²⁾	179
K014990	SN7137	²⁾	178	K015427	SN7028		179
K014991	SN7086	²⁾	178	K015428	SN7038	²⁾	179
K014992	SN7096	²⁾	178	K015429	SN7028	²⁾	179
K014993	SN7247	²⁾	178	K015430	SN7038	²⁾	179
K014994	SN7257	²⁾	178	K015444	EL2203		25
K014995	SN7247	²⁾	178	K015468N00	–		90
K014996	SN7257	²⁾	178	K015506	PU16CS		50
K014997	SN7086	²⁾	178	K015507	PU16CD		50
K014998	SN7096	²⁾	178	K015508	PU16DS		50
K014999	SN7125	²⁾	178	K015509	PU16DD		50
K015000	SN7135	²⁾	178	K015510	PU16DXS		50
K015001	SN7126	²⁾	178	K015511	PU16DXD		50
K015002	SN7136	²⁾	178	K015518	LP8701		13
K015003	SN7126	²⁾	178	K015557	SN7324	¹⁾	179
K015004	SN7136	²⁾	178	K015558	SN7334	¹⁾	179
K015005	SN7228	²⁾	178	K015559	SN7323	²⁾	179
K015006	SN7238	²⁾	178	K015560	SN7333	²⁾	179
K015007	SN7228	²⁾	178	K015579	BS3316		133
K015008	SN7238	²⁾	178	K015580	BS3317		133
K015009	SN7240	²⁾	178	K015581	BS2402	²⁾ K017984 (BS2402)	132
K015010	SN7250	²⁾	178	K015582	BS2408	²⁾ K017985 (BS2408)	132
K015013	SN7229	²⁾	178	K015583	BS2406	²⁾ K017982 (BS2406)	132
K015014	SN7239	²⁾	178	K015584	BS2407	²⁾ K017983 (BS2407)	132
K015015	SN7229	²⁾	178	K015585	BS3507		134
K015016	SN7239	²⁾	178	K015586	BS3511		134
K015071	LA8148	²⁾ K014986N00 (LA8145)	20	K015588	BS3521	²⁾ K017944 (BS3521)	134
K015072	LA8149	²⁾ K014981N00 (LA8146)	20	K015589	BS3536		134

Products in Part Number order
Produkte, nach Teilenummern geordnet

Classification des Produits par Numero
Prodotti ordinati per Codice

Part Number	Type Number	Replacement/Remplacé par Ersatz / Sostituito da	Page	Part Number	Type Number	Replacement/Remplacé par Ersatz / Sostituito da	Page
K015590	BS3537		134	K016623	SN5011	²⁾	179
K015591	BS3526		134	K016626	SN5001	²⁾	179
K015592	BS3528		134	K016627	SN5011	²⁾	179
K015676N00	–		83	K016629N00	–		91, 118
K015677N00	–		83	K016630N00			91, 118
K015713N00	–		186	K016654	RP2B		61
K015762	BS9580		150	K016660N00	–		90
K015804DC	SN6550	²⁾	179	K016685	AC597BJ		65
K015805DC	SN6560	²⁾	179	K016806	PU17DXS		50
K015806DC	SN6504	²⁾	179	K016807	PU17DXD		50
K015807DC	SN6514	²⁾	179	K016811	SN7263	²⁾	179
K015826	PU12DS		50	K016812	SN7273	²⁾	179
K015827	PU12DD		50	K016813	SN7169	²⁾	179
K015833	BS3800	²⁾	134	K016814	SN7179	²⁾	179
K015834	BS3801	²⁾	134	K016827	SN7066	²⁾	179
K015849N00	AE4311		77, 108	K016828	SN7076	²⁾	179
K015857	–	²⁾ K039455	30	K016829	SN7042	²⁾	179
K015875N50	–		212	K016830	SN7052	²⁾	179
K015948	LP3997		13	K016929	BY9452		143
K015948000	LP3997	²⁾ K015948 (LP3997)	13	K016932	LK3869		12
K015965	LK4928		15	K016932000	LK3869	²⁾ K016932 (LK3869)	12
K015972	SN5001	¹⁾	179	K016947			232
K015973	SN5011	¹⁾	179	K016991N00	–		90, 116, 123
K016152	T3700-I		160	K017003N00			91, 110, 118
K016153	T3700-D		160	K017049	DPM90DDX		54
K016480	BS2546		132	K017050	DPM90DSX		54
K016481	BS2547		132	K017062			232
K016484	BS8350		146	K017119N00	BS8500		146
K016485	BS8351		146	K017120N00	BS8501		146
K016510	DX80EX		48	K017121N00	BS8525		147
K016524	SN7309	²⁾	179	K017122N00	BS8526		147
K016524DC		²⁾	179	K017123N00	BS9527		149
K016525	SN7319	²⁾	179	K017172	SN6500	²⁾	179
K016525DC		²⁾	179	K017173	SN6510	²⁾	179
K016526	SN7309	¹⁾	179	K017195	SN7329	²⁾	179
K016527	SN7319	¹⁾	179	K017196	SN7339	²⁾	179
K016528	SN7309	²⁾	179	K017224N00	AE1141		108, 206
K016529	SN7319	²⁾	179	K017274	LK3846		12
K016601N00	LA8073		20	K017294	LA8544		22
K016602	LA8074	²⁾ K016602N00 (LA8074)	20	K017395	SN7283	²⁾	179
K016602N00	LA8074		20	K017396	SN7293	²⁾	179
K016615	LK4941	²⁾ K016615000 (LK4941)	15	K017419N00	SC5A		215
K016615000	LK4941		15	K017428	LP3974		13
K016618	SN5001	²⁾	179	K017428000	LP3974	²⁾ K017428 (LP3974)	13
K016619	SN5011	²⁾	179	K017436N00	SC6A		215
K016620	SN5011	²⁾	179	K017477	SN7340	²⁾	179
K016621	SN5001	²⁾	179	K017478	SN7350	²⁾	179
K016622	SN5001	²⁾	179	K017479	SN7341		179

Products in Part Number order
Produkte, nach Teilenummern geordnet

Classification des Produits par Numero
Prodotti ordinati per Codice

Part Number	Type Number	Replacement/Remplacé par Ersatz / Sostituito da	Page	Part Number	Type Number	Replacement/Remplacé par Ersatz / Sostituito da	Page
K017480	SN7351		179	K019284	LK3848		12
K017503N00	-		123	K019300V02N50	ES2060	²⁾ K019300V03N50 (ES2060)	112
K017527000	LK4944		15	K019300V03N50	ES2060		112
K017528	LK4954		15	K019302V02N50	ES2060	²⁾ K019302V03N50 (ES2060)	112
K017528000	LK4954	²⁾ K017528 (LK4954)	15	K019302V03N50	ES2060		112
K017710	LA8542	²⁾ II19208 (LA8211)	21	K019312V03N00	-	²⁾ K019312V04N00 (ES2060)	112
K017711	LA8543	²⁾	22	K019312V04N00	ES2060		112
K017813N00	-		83	K019340V01N50	ES2060	²⁾ K019340V02N50 (ES2060)	108, 112
K017944	BS3521		134	K019340V02N50	ES2060		108, 112
K017982	BS2406		132	K019342V01N50	ES2060	²⁾ K019342V02N50 (ES2060)	108, 112
K017983	BS2407		132	K019342V02N50	ES2060		108, 112
K017984	BS2402		132	K019350V02N00	ES2060		108, 112
K017985	BS2408		132	K019352V00N00	ES2060	¹⁾ K019352V02N00 (ES2060)	108, 112
K017986	BS3800		134	K019352V02N00	ES2060		108, 112
K017987	BS3801		135	K019417	SN7346	²⁾	179
K017988	BS3806		135	K019418	SN7356	²⁾	179
K018094	BS9510	²⁾ K018094N00 (BS9510)	149	K019467N00			231
K018094N00	BS9510		149	K019470N00			230
K018097	-		33	K019471N00			230
K018110N00	KU4128		67	K019472N00			231
K018111N00	KU4124		67	K019562	SN7348	²⁾	179
K018155	BT5708		150	K019563	SN7358	²⁾	179
K018158	BT5709		150	K019759	SN7347	²⁾	179
K018199	BS2409		132	K019760	SN7357	²⁾	179
K018200	BS2410		132	K019786N00	-		111
K018266	BS3507		134	K019819N50	-		204
K018267	BS3511		134	K019820N50	-		204
K018308N00	-		123	K019821N50	-		204
K018310N00	-		123	K019858	-	²⁾	212
K018312N00	-		123	K019882N00	AE1141		108, 206
K018385	LK3866		12	K019904	AE4641		41
K018385000	-	²⁾ K018385 (LK3866)	12	K019905	AE4642		41
K018395	LA8054		20	K019906	AE4643		41
K018578	LA8546		22	K019907	AE4644		41
K018605N00			231	K019908	AE4645		41
K018625000	LK4961		15	K019909	AE4646		41
K018797N01	DPM64SF	²⁾	54	K019911	AE4648		41
K018953N01	DPM64MP	²⁾	54	K019929	-	²⁾	33
K018954N01	DPM65MP	²⁾	54	K019976N00	BY9282		144
K018955N01	DPM66MP	²⁾	54	K019977N00	BY9283		144
K018956N01	DPM67MP	²⁾	54	K019993N00	BY9334		144
K019013	SN6507	¹⁾	179	K019994N00	BY9335		144
K019014	SN6517	¹⁾	179	K020004N00	BY9466		144
K019133	BS3294		133	K020005N00	BY9467		144
K019136	SN7042	¹⁾	179	K020020	-	²⁾ K032014N50	97
K019137	SN7052	¹⁾	179	K020021	-	²⁾ K032014N50	97
K019158	LK4962	¹⁾ K037049N00 (LK4962)	15	K020022	-	²⁾ K020023N50	97
K019253	-		70	K020023	-	²⁾ K020023N50	97

Products in Part Number order
Produkte, nach Teilenummern geordnet

Classification des Produits par Numero
Prodotti ordinati per Codice

Part Number	Type Number	Replacement/Remplacé par Ersatz / Sostituito da	Page	Part Number	Type Number	Replacement/Remplacé par Ersatz / Sostituito da	Page
K020023N50	–		97	K021919N00	PU3MYS		49
K020024	–	²⁾ K020024N50	97	K021920N00	PU3MYD		49
K020024N50	–		97	K021940V00N00	ES2070	²⁾	108, 113
K020123N00	AE4311		77, 108	K022011N00	MC2B		213
K020337	LA8075	²⁾ K020337N00 (LA8075)	20	K022028N00	SM1PLB		49, 208
K020337N00	LA8075		20	K022166N00	–		58
K020338	LA8076	²⁾ K020338N00 (LA8076)	20	K022185N00	DB1150		44
K020338N00	LA8076		20	K022249N00	LP4857		16
K020568N50	–		101	K022263N00	LK4936		15
K020622	–	²⁾ K020623N50	100	K022264N00	LK4952		15
K020623	–	²⁾ K020623N50	100	K022272N00	–		124
K020623N50	–		100	K022273N00	–		91
K020624	–	²⁾ K020624N50	100	K022274N00			91
K020624N50	–		100	K022279N00	–		124
K020625	–	²⁾ K020623N50	100	K022369	LA8545		22
K020626N50	–		100	K022468N00	–		206
K020646	–	²⁾ K039453	30	K022470N00	PU4MYS		49
K020741	–	²⁾ K020741N50 (EL1100)	25	K022821	–		35
K020741N50	EL1100		25	K022847N00	SV3801		200
K020742	–	²⁾ K020742N50 (EL1101)	25	K023210	SB7227	²⁾	179
K020742N50	EL1101		25	K023211	SB7237	²⁾	179
K020814N00	BY9338		144	K023213	–	²⁾ K020023N50	97
K020878N00	DB2122		63	K023215	–	²⁾ K023215N50	97
K021138N00	–		109, 116	K023215N50	–		97
K021178N00	BY9340		144	K023216	–	²⁾ K023216N50	97
K021179N00	BY9341		144	K023216N50	–		97
K021202N50	–		96	K023311N00	–		58
K021203	–	²⁾ K021203N50	96	K023357	LA8702		22
K021203N50	–		96	K023400	LA8547	²⁾	22
K021204N50	–		96	K023558	SN7361		179
K021211N00	–		136	K023559	SN7371		179
K021231	–	²⁾ K024928N50	99	K023627	SB7966	²⁾	179
K021266N00	DB2115		63	K023628	SB7976	²⁾	179
K021312N06	–	²⁾	83	K023629	SN7362	²⁾	179
K021335N00	–		109, 118	K023630	SN7372	²⁾	179
K021336N00	–		109, 118	K023735	SN7067	²⁾	179
K021337N00	–		118	K023736	SN7077	²⁾	179
K021338N00	–		118	K023796	SK7009	²⁾	179
K021340N00	–		110, 119, 123	K023797	SK7019	²⁾	179
K021342N00	–		119, 123	K023831	MC3A		50
K021343N00	–		119, 123	K023831N00	MC3A		213
K021345N00	–		110, 119	K024074	–	²⁾	212
K021346N00	–		119	K024357	LK4945	¹⁾ K026846N01 (LK4968)	15
K021643N00	–		111, 119	K024358	LK4945	¹⁾ K026846N01 (LK4968)	15
K021644N00	–		111, 119	K024410N00	LK4951		15
K021666	SK7025	¹⁾	179	K024480N00	PU18DS		50
K021667	SK7035	¹⁾	179	K024486	LA9013		22
K021896	DX65DH		48, 50	K024500N00	PU4MYD		49

Products in Part Number order
Produkte, nach Teilenummern geordnet

Classification des Produits par Numero
Prodotti ordinati per Codice

Part Number	Type Number	Replacement/Remplacé par Ersatz / Sostituito da	Page	Part Number	Type Number	Replacement/Remplacé par Ersatz / Sostituito da	Page
K024634	LA9034	²⁾ K024634N00 (LA9034)	22, 24	K026949N00	CAM1BS		216
K024634N00	LA9034		22, 24	K027811N00	–		119
K024635	LA9035	²⁾ K024635N00 (LA9035)	22, 24	K027813N00	–		119
K024635N00	LA9035		22, 24	K027814N00	–		119
K024645N00	PU4BMYS		49	K027815N00	–		119
K024648N00	PU4BMYD		49	K027900V00N00	ES2071		108, 113
K024731	SN6628	²⁾	179	K028000N00	–		116
K024732	SN6638	²⁾	179	K028001N00	–		116
K024733	SN6629	²⁾	179	K028024	SK7025	²⁾	180
K024734	SN6639	²⁾	179	K028025	SK7035	²⁾	180
K024735	SN6630	²⁾	179	K028030	LA8555	²⁾	22
K024736	SN6640	²⁾	179	K028079N00	BS3296		133
K024737	SN6631	²⁾	179	K028080N00	BS3297		133
K024738	SN6641	²⁾	180	K028143	SN7367	²⁾	180
K024764N00	SV1460		197	K028144	SN7377	²⁾	180
K024765N00	SV1307		197	K028205	ZB4418		23
K024928	–	²⁾ K024928N50	99	K028206	ZB4420		23
K024928N50	–		99	K028207	ZB4427		23
K025294N00	ZB4721		24	K028232N09	DPM60AJ	²⁾	53
K025295	ZB4809	²⁾ K025295N00 (ZB4809)	24	K028234N09	DPM61AJ	²⁾	53
K025295N00	ZB4809		24	K028253N00	DPA5001		152
K025340N00			230	K028254N00	DPA6101		152
K025367	BS3810		135	K028266N00	DPA6102		152
K025441N00	DPM93DEY		54	K028300N00	DPA6103		152
K025546	AE4535		40	K028388N00	DPA6104		152
K025606	LA8704		22	K028491N00	–		116
K025626	SN6551	²⁾	180	K028583N00	–		116
K025627	SN6561	²⁾	180	K028586N00	–		119
K025699	AE4371		108	K028608	DR4265		38
K025699N00	AE4371		77	K028614N00	BS4502		135
K025700N00	AE4370		77, 108	K028697N00	BS3379		133
K025912	–	²⁾ K039453	30	K028699N00	BS6411		145
K026632	BS8484		146	K028700N00	BS6412		145
K026822	AE4544		24, 40	K028809N00	BS6413		145
K026831N00	DPA6100		152	K028810N00	BS6414		145
K026832N00	DPA5000		152	K029059N00	BS8559		147
K026846N01	LK4968	²⁾	15	K029098		²⁾	180
K026887N00	BS6408		145	K029099		²⁾	180
K026888N00	BS6409		145	K029100		²⁾	180
K026894N00	BS7304		151	K029101		²⁾	180
K026896N00	BS7309		151	K029225	–		35
K026898N00	BS7312		151	K029229N00	BS6415		145
K026899N00	BS7313		151	K029230N00	BS6416		145
K026900N00	BS7318		151	K029301N00	MC2AKR		213
K026901N00	BS7319		151	K029374N00	–		130
K026903N00	BS7351		151	K029411N00	MC2AR		213
K026904N00	BS7355		151	K029440N00	BS3298		133
K026905N00	BS7356		151	K029441N00	BS3299		133

Products in Part Number order
Produkte, nach Teilenummern geordnet

Classification des Produits par Numero
Prodotti ordinati per Codice

Part Number	Type Number	Replacement/Remplacé par Ersatz / Sostituito da	Page	Part Number	Type Number	Replacement/Remplacé par Ersatz / Sostituito da	Page
K029501N00	BS8560		147	K033367N50	ZB4275		17
K029502N00	BS8561		147	K033392N00	LP4864		16
K031426	SN7041	2)	180	K033404N00	LP4865		16
K031427	SN7051	2)	180	K033412N00	LK4963		15
K031428	SN7264	1)	180	K033949N00	ZB4724		24
K031429	SN7274	1)	180	K033952	LA8157	2)	21, 24
K031430	SN7040	2)	180	K035001N00	LP4871		16
K031431	SN7050	2)	180	K035389N00	AC156F		44
K031432	SN7260	1)	180	K035432		2)	180
K031433	SN7270	1)	180	K035433		2)	180
K031434	SN7045	2)	180	K035435N04	LS3907	2)	13
K031435	SN7055	2)	180	K035570N00	AE1141		206
K031436	SB7221	1)	180	K035707N00	–		43
K031437	SB7231	1)	180	K036198V00N00	EZ2085		113
K031438	SB7189	2)	180	K036496	–	2)	35
K031439	SB7199	2)	180	K036798	SN7400	2)	180
K031440	SB7202	2)	180	K036799	SN7410	2)	180
K031441	SB7212	2)	180	K037049N00	LK4962		15
K031442	SB7202	1)	180	K037065	–	2) K039453	30
K031443	SB7212	1)	180	K037810N00	BX7542		141
K031451N00	BS8263		145	K037833N00	–		75
K031469N00	BS8264		145	K037970N00	BX7515		141
K031475N00	PU16CXS		50	K037983N00	BX7414		141
K031478N00	PU16CXD		50	K038535N00	BX7543		141
K031532N00	BS4503		135	K038537N00	BX7545		141
K031533N00	BS4504		135	K038538N00	BX7618		141
K031597N00	BS3811		135	K038828N00	BS6421		145
K031598N00	BS3812		135	K038829N00	BS6422		145
K031601N00	BS2323		132	K038830N00	BS8485		146
K031708N03	ZB4723	2)	24	K039062K50	–		232
K031711N00	BY9287		142	K039066N00	BS8562		147
K031736N00	BX7401		141	K039067N00	BS8563		147
K031737N00	BX7402		141	K039453	–		30
K031738N00	BX7516		141	K039454	–		30
K031739N00	BX7523		141	K039455	–		30
K031740N00	BX7525		141	K039468	SN7264	2)	180
K031744N00	BX7611		141	K039530	–	2) K039530N50	99
K031745N00	BX7612		141	K039530N50	–		99
K031748N00	BX7514		141	K039544	–	2) K039544N50	99
K032014N50	–		97	K039544N50	–		99
K032483N00	–		130	K039546N50	–		99
K032543	SB7220	2)	180	K039569	–	2) K039569N50	99
K032544	SB7230	2)	180	K039569N50	–		99
K032585	SN6541	2)	180	K039571N50	–		99
K032586	SN6551	2)	180	K03986	–		83
K033209N01	EL2201	2)	25	K040156	–	2) K040156N50	99
K033210N01	EL2203	2)	25	K040156N50	–		99
K033356	LA8156		20, 24	K040158N50	–		99

Products in Part Number order
Produkte, nach Teilenummern geordnet

Classification des Produits par Numero
Prodotti ordinati per Codice

Part Number	Type Number	Replacement/Remplacé par Ersatz / Sostituito da	Page	Part Number	Type Number	Replacement/Remplacé par Ersatz / Sostituito da	Page
K040159	-	²⁾ K040159N50	99	K045322	SN7040	²⁾	180
K040159N50	-		99	K045323	SN7050	²⁾	180
K040214	DR4160		38	K045324	SN7045	²⁾	180
K040215	DR4266		38	K045325	SN7055	²⁾	180
K040216	DR4395		38	K046291K50	-		232
K040218	DR4397		38	K047412	SB7187	²⁾	180
K040265N00	PU12CXS		50	K047413	SB7197	²⁾	180
K040266N00	PU12CXD		50	K2B0504X50	-		138
K040267N00	PU12DXS		50	K2B0504X55	-	²⁾ K2B0504X50	138
K040268N00	PU12DXD		50	K2B0504XU	-	²⁾ K2B0504X50	138
K040432N00	LK3947		12	K2B0506X50	-		138
K040676N00	DR5128		192	K2B0506X55	-	²⁾ K2B0506X50	138
K040911	SN6577	²⁾	180	K2B0506XU	-	²⁾ K2B0506X50	138
K040912	SN6587	²⁾	180	K2B0513X50	-		138
K040960N00	LK8905		13	K2B0513XU	-	²⁾ K2B0513X50	138
K041454	SN7405	²⁾	180	K2B0514X50	-		138
K041455	SN7415	²⁾	180	K2B0514X55	-	²⁾ K2B0514X50	138
K041984N00	-		130	K2B0514XU	-	²⁾ K2B0514X50	138
K041990N00	BZ9646		139	K2B0520X50	-		138
K044312S01	SM1LA	²⁾	208	K2B0520XU	-	²⁾ K2B0520X50	138
K044694	-	²⁾ K044694N50	99	K2B0521X50	-		138
K044694N50	-		99	K2B0521XU	-	²⁾ K2B0521X50	138
K044873N00	SM2PD		49, 50, 208	K2B0522X50	-		138
K044874N00	SM2PA		49, 208	K2B0522XU	-	²⁾ K2B0522X50	138
K045254N00	BZ3324		126	K2B0528X50	-		138
K045255N00	BZ3438		127	K2B0528XU	-	¹⁾ K2B0528X50	138
K045256N00	BZ3439		127	K2B0543X50	-		139
K045257N00	BZ3537		127	K2B0543XU	-	¹⁾ K2B0543X50	139
K045258N00	BZ3538		127	K2B1034	-	²⁾ K2B1034VE	139
K045260N00	BZ3441		127	K2B1034VE	-	¹⁾	139
K045261N00	BZ3442		127	K2B1035	-	²⁾ K2B1035VE	139
K045262N00	BZ3443		127	K2B1035VE	-	²⁾	139
K045263N00	BZ3444		127	K2B1101X50	-		139
K045264N00	BZ3464		127	K2B1101XU	-	²⁾ K2B1101X50	139
K045265N00	BZ3555		127	K2B1144	-	²⁾ K2B0521X50	138
K045266N00	BZ3332		126	K2B1145	-	²⁾ K2B0521X50	138
K045267N00	BZ3473		127	K2B1149	-	²⁾ K2B0506X50	138
K045268N00	BZ3480		127	K2B1157	-	²⁾ K2B0521X50	138
K045269N00	BZ3481		127	K2B1164VE	-	¹⁾	139
K045270N00	BZ3573		127	K2B1187	-	²⁾ K2B0522X50	138
K045271N00	BZ3353		127	K2B1188	-	²⁾ K2B0521X50	138
K045272N00	BZ3588		127	K2B1193	-		139
K045273N00	BZ3589		127	K2B1224	-	¹⁾ K2B0506X50	138
K045274N00	BZ3491		127	K2C2004X50	-		139
K045275N00	BZ3490		127	K2C2004XU	-	²⁾ K2C2004X50	139
K045276N00	BX3540		126	K2D3012	-		139
K045318	SN7041	²⁾	180	K2D3013	-		139
K045319	SN7051	²⁾	180	K2D3014	-		139

Products in Part Number order
Produkte, nach Teilenummern geordnet

Classification des Produits par Numero
Prodotti ordinati per Codice

Part Number	Type Number	Replacement/Remplacé par Ersatz / Sostituito da	Page	Part Number	Type Number	Replacement/Remplacé par Ersatz / Sostituito da	Page
K2E4002X50	–		142	KA628450	–	¹⁾ 628450AM	211
K2E4002XU	–	²⁾ K2E4002X50	142	KA628493	–	¹⁾ 628493AM	211
KA266321	–	²⁾ 626321AM	220	KA628494	–	¹⁾ 628494AM	211
KA622107	–	¹⁾ 622107AM	211	KA629298	–	²⁾ 629298AM	214
KA622109	–	¹⁾ 622109AM	211	KA629300	–	²⁾ 629300AM	211
KA622190	–	¹⁾ 622190AM	211	KA629614	–	²⁾ 629614AM	221
KA622199	–	¹⁾ 622199AM	211	KA630388	–	²⁾ 630388AM	220
KA622502	–	¹⁾ 622502AM	211	KB1000	–		155
KA623104	–	¹⁾ 623104AM	214	KB1010	–		155
KA623105	–	¹⁾ 623105AM	214	KB1030	–		155
KA623106	–	¹⁾ 623106AM	214	KB1500	–		155
KA623109	–	¹⁾ 623109AM	214	KB1505	–		155
KA623160	–	¹⁾ 623160AM	214	KB1510	–		155
KA624199	–	¹⁾ 624199AM	211	KB1515	–		155
KA624503	–	¹⁾ 624503AM	214	KB1520	–		155
KA625290	–	¹⁾ 625290AM	211	KB1525	–		155
KA625375	–	¹⁾ 625375AM	211	KB1530	–		155
KA625524	–	¹⁾ 625524AM	211	KB1535	–		155
KA625586	–	¹⁾ 625586AM	211	KB2010	–		155
KA625826	–	¹⁾ 625826AM	214	KB2015	–		155
KA625862	–	¹⁾ 625862AM	211	KB2020	–		155
KA626159	–	¹⁾ 626159AM	214	KB2025	–		155
KA626162	–	¹⁾ 626162AM	211	KB2040	–		155
KA626196	–	¹⁾ 626196AM	214	KB2070	–		155
KA626392	–	¹⁾ 626392AM	211	KB2075	–		155
KA626565	–	¹⁾ 626565AM	214	KB2080	–		156
KA626597	–	²⁾ 626597AM	221	KB2115	–		156
KA626639	–	¹⁾ 626639AM	211	KB2125	–		156
KA626662	–	²⁾ 626662AM	220	KB2170	–		156
KA626693	–	¹⁾ 626693AM	211	KB2220	–		156
KA626760	–	¹⁾ 626760AM	214	KB2230	–		156
KA626762	–	¹⁾ 626762AM	214	KB2235	–		156
KA626853	–	¹⁾ 626853AM	211	KB2240	–		156
KA627494	–	²⁾ 627494AM	221	KB2245	–		156
KA627496	–	²⁾ 627496AM	220	KB2250	–		156
KA627497	–	¹⁾ 627497AM	211	KB2260	–		156
KA627498	–	¹⁾ 627498AM	211	KB2275	–		156
KA627612	–	¹⁾ 627612AM	211	KB2610	–		156
KA627692	–	¹⁾ 627692AM	211	KB2615	–		156
KA628027	–	¹⁾ 628027AM	211	KB2630	–		156
KA628036	–	¹⁾ 628036AM	211	KB2635	–		156
KA628258	–	¹⁾ 628258AM	211	KB2735	–		156
KA628259	–	¹⁾ 628259AM	211	KB2740	–		156
KA628260	–	¹⁾ 628260AM	211	KB2775	–		156
KA628275	–	¹⁾ 628275AM	211	KB2780	–		156
KA628276	–	¹⁾ 628276AM	211	KB2920	–		156
KA628277	–	¹⁾ 628277AM	211	KB3030	–		156
KA628448	–	¹⁾ 628448AM	211	KB3035	–		156

Products in Part Number order
Produkte, nach Teilenummern geordnet

Classification des Produits par Numero
Prodotti ordinati per Codice

Part Number	Type Number	Replacement/Remplacé par Ersatz / Sostituito da	Page	Part Number	Type Number	Replacement/Remplacé par Ersatz / Sostituito da	Page
KB3040	-		156	KX175/1	-		192
KB3045	-		156	KX175/4	-		192
KB3485	-		156	KX2000/1	-		62
KB3490	-		156	KX2045/11	-	²⁾ KX2045/11000	43
KB6500	-		156	KX2045/11000	-		43
KB6505	-		156	KX2045/14	-	²⁾ KX2045/14000	43
KB6510	-		156	KX2045/14000	-		43
KB6515	-		156	KX2045/16	-	²⁾ KX2045/16000	43
KB6520	-		156	KX2045/16000	-		43
KB6525	-		156	KX2045/17	-	²⁾ KX2045/17000	43
KB6530	-		156	KX2045/17000	-		43
KB6535	-		156	KX2045/4	-	¹⁾ KX2045/14000	43
KB6540	-		156	KX2045/6	-	¹⁾ KX2045/16000	43
KB6545	-		156	KX2045/7	-	¹⁾ KX2045/17000	43
KB6620	-		156	KX2068/2	-		31
KB6625	-		156	KX2068/2SP	-	¹⁾ KX2068/2	31
KB6630	-		156	KX2068/3	-	¹⁾ KX2068/2	31
KB6660	-		156	KX2068/4	-	¹⁾ KX2068/5	31
KB6665	-		156	KX2068/5	-		31
KB6670	-		157	KX2068/8	-		31
KB6675	-		157	KX2073/13	-		192
KB7638	-		116	KX2073/7	-		192
KG25011.0.1	-		213	KX2196/1	-		62
KG28020.0.1	-	¹⁾ KG25011.0.1	213	KX2196/1000	-	¹⁾ KX2196/1	62
KW2350/1	-		31	KX2552/1	-	¹⁾ 1186892	62
KW2350/2	-		31	KX2552/2	-	¹⁾ KX2552/3	62
KW2350/5	-	¹⁾ KW2350/1	31	KX2552/3	-		62
KW2966/1	-		70	KY1036/12	-	¹⁾ KY1038/3	57
KW3205/1	-		70	KY1038/2	-	¹⁾ KY1038/3	57
KW3405/1	-		228	KY1038/3	-	²⁾	57
KW3405/2	-		228	KY1467/23	-		53
KW4069/1	-		188	KY1467/23XU	-	¹⁾ KY1467/23	53
KW4081/1	-		37	KY1767/10	-		48
KW4282/2	-		228	KY1810/1	-		60
KW4455/1	-		70	KY1916/1	-		48
KW4648/1	-		70	KY1916/4	-		48
KW5271/1	-	²⁾	70	KY1932/1	-	¹⁾ 1186938	57
KW718/2	-		31	KY1956/5	-	²⁾	57
KX1294/1	-		62	KY2106/5	-		65
KX1294/1N	-	²⁾ KX1294/1	62	KY2111/7	-		65
KX1294/2	-		62	KY2114/1	-	¹⁾ KY2498/1	53
KX1294/4	-		62	KY2184/1	-		57
KX1294/5	-	²⁾ KX1294/4	62	KY2193/1	-		57
KX1729/1	-		192	KY2193/2	-		57
KX1729/2	-		192	KY2248/1	-		57
KX1729/3	-		192	KY2308/1	-	¹⁾ AC574CXY	60
KX1729/4	-		192	KY2357/1	-		53
KX1729/5	-		192	KY2498/1	-		53

Products in Part Number order
Produkte, nach Teilenummern geordnet

Classification des Produits par Numero
Prodotti ordinati per Codice

Part Number	Type Number	Replacement/Remplacé par Ersatz / Sostituito da	Page	Part Number	Type Number	Replacement/Remplacé par Ersatz / Sostituito da	Page
KY2590/2	–	¹⁾ KY2590/4	62	SEB00069	AE4215	¹⁾ II36134 (AE4233)	78
KY2590/4	–		62	SEB00071	KU1311	¹⁾ II17355 (KU1311)	67
KY2590/5	–		62	SEB00077	KU4124	¹⁾ K004231 (KU4124)	67
KY890/1	–		57	SEB00080	KU4128	¹⁾ K004230 (KU4128)	67
KZ1087/4	–		15	SEB00224R	EE1100	²⁾	31
KZ1254/3	–	²⁾ K028388N00 (DPA6104)	152	SEB00225	KU1310	²⁾ II17354 (KU1310)	67
KZ1254/3XU	–	²⁾ K028388N00 (DPA6104)	152	SEB00226	KU1311	¹⁾ II17355 (KU1311)	67
KZ1258/2	–	¹⁾ K003845000 (BY9233)	142	SEB00227	KU4124	¹⁾ K004231 (KU4124)	67
KZ1310/1	–	¹⁾ II30178 (LA8223)	21	SEB00228	KU4128	¹⁾ K004230 (KU4128)	67
KZ1310/2	–	¹⁾ II30178 (LA8223)	21	SEB00229	KU1324	²⁾ K000955 (KU1411)	67
KZ1327/1	–	¹⁾ II30182 (LA8224)	21	SEB00285	AB2793	¹⁾ 0481061220000	64
KZ433/1RM	–	¹⁾ KZ433/1X50	15	SEB00286	AB2802	¹⁾ 0481061230000	64
KZ433/1X50	–		15	SEB00318	BZ7408	¹⁾ II37274 (BX9400)	139
KZ433/5	–	¹⁾ 1186722SP	15	SEB00321	BZ7421	¹⁾ II37274 (BX9400)	139
KZ433/5SP	–	¹⁾ 1186722SP	15	SEB00348	LP3832	¹⁾ SEB01151 (LP3860)	13
KZ488/11RM	–	¹⁾ K2C2004X50	139	SEB00416	LP1596	¹⁾ SEB01686000 (LK1567)	12
KZ642/2RM	–	²⁾ KZ642/2X50	15	SEB00425	BZ7408	¹⁾ II37274 (BX9400)	139
KZ642/2X50	–		15	SEB00426	BZ7421	¹⁾ II37274 (BX9400)	139
KZ6422RM	–	¹⁾ KZ642/2X50	15	SEB00429	AB2793	¹⁾ 0481061220000	64
KZ758/1ARM	–	¹⁾ K2B1101X50	139	SEB00430	AB2802	¹⁾ 0481061230000	64
KZ7581ARM	–	¹⁾ K2B1101X50	139	SEB00436	KU4124	¹⁾ K004231 (KU4124)	67
KZ774/2RM	–	¹⁾ K2B0543X50	139	SEB00437	KU4128	¹⁾ K004230 (KU4128)	67
KZ775/2RM	–	¹⁾ K2B0528X50	138	SEB00510	BZ7451	¹⁾ II37274 (BX9400)	139
KZ794/1RM	–	¹⁾ K2C2004X50	139	SEB00560	AB2793	¹⁾ 0481061220000	64
KZ794/2RM	–	¹⁾ K2C2004X50	139	SEB00601	BZ7455	¹⁾ II37274 (BX9400)	139
KZ794/4RM	–	¹⁾ K2C2004X50	139	SEB00650	LP3852	¹⁾ SEB01152000 (LP3861)	13
KZ804/2RM	–	¹⁾ K2B0504X50	138	SEB00659	BR4352		57
KZ805/2RM	–	¹⁾ K2B0506X50	138	SEB00681	KU4124	¹⁾ K004231 (KU4124)	67
KZ806/2RM	–	¹⁾ K2B0521X50	138	SEB00682	KU4128	¹⁾ K004230 (KU4128)	67
KZ965/12RM	–	¹⁾ K2B0528X50	138	SEB00684	DR4502		38
KZ96512RM	–	¹⁾ K2B0528X50	138	SEB00786	AB2802	²⁾ 0481061230000	64
LS1000	–	¹⁾ LS1500	206	SEB00791	AB2793		65
LS1500	–		206	SEB00820	LP4818	²⁾ SEB00820000 (LP4818)	16
LS2000	–		206	SEB00820000	LP4818		16
MP70A	–		58	SEB00875	AB2838	²⁾ 0481061248000	64
PU1AYD	–		49	SEB00901	AE4230	¹⁾ II36128 (AE4230)	77, 108
PU1AYS	–		49	SEB00917	AE4232	¹⁾ II36133 (AE4232)	78
PU3AYD	–		49	SEB00918	AE4233	¹⁾ II36134 (AE4233)	78
PU3AYS	–		49	SEB01098	MB4611		48
PU4AYD	–		49	SEB01100	RE3310	¹⁾ II39050F000 (RE3312)	61
PU4AYS	–		49	SEB01115	AE4440		40
PU5CD	–		49	SEB01149	LK1554	¹⁾ SEB01686000 (LK1567)	12
PU5CS	–		49	SEB01151	LP3860		13
PU5DD	–		49	SEB01152	LP3861	²⁾ SEB01152000 (LP3861)	13
PU5DS	–		49	SEB01152000	LP3861		13
SC2BK	–	¹⁾ K010198 (SC2CK)	215	SEB01152R	LP3861	²⁾ SEB01152000 (LP3861)	13
SEB00066	KU1310	¹⁾ II17354 (KU1310)	67	SEB01154000	LP4939	¹⁾	16
SEB00068	AE4214	¹⁾ II36133 (AE4232)	78	SEB01156000	LP4941		16

Products in Part Number order
Produkte, nach Teilenummern geordnet

Classification des Produits par Numero
Prodotti ordinati per Codice

Part Number	Type Number	Replacement/Remplacé par Ersatz / Sostituito da	Page	Part Number	Type Number	Replacement/Remplacé par Ersatz / Sostituito da	Page
SEB01158	LP4943	²⁾ SEB01158000 (LP4943)	16	SEB01597000	LK3834		12
SEB01158000	LP4943		16	SEB01604	LK3839	¹⁾ K008457000 (LK3875)	12
SEB01159000	LP4944		16	SEB01605	LK3840	²⁾ K002141000 (LK3840)	12
SEB01163	BR5522	¹⁾ I136836 (BR5522)	58	SEB01606	LK3841	¹⁾ K004640X00 (LK3841)	12
SEB01183	DB1237		44	SEB01676	LP4999		16
SEB01214	AE4247	¹⁾ I136129 (AE4247)	77, 108	SEB01686	LK1567	²⁾ SEB01686000 (LK1567)	12
SEB01224	DB1239		44	SEB01686000	LK1567		12
SEB01237	-		43	SEB01747	LP4855		16
SEB01241	BR5524		58	SEB01751	LP3970	¹⁾ K004641000 (LP3970)	13
SEB01245	LP4832		16	SEB01768	LK3850	²⁾ SEB01768000 (LK3850)	12
SEB01245000	LP4832	²⁾ SEB01245 (LP4832)	16	SEB01768000	LK3850		12
SEB01258	DB1240		44	SEB01781	LP4830		16
SEB01265	AE4214	¹⁾ I136133 (AE4232)	78	SEB01781X00	LP4830	²⁾ SEB01781 (LP4830)	16
SEB01267	BX7514	²⁾ K031748N00 (BX7514)	141	SEB01782	LP4823	²⁾ SEB01782000 (LP4823)	16
SEB01268	BX7515	²⁾ K037970N00 (BX7515)	141	SEB01782000	LP4823		16
SEB01269	BX7401	²⁾ K031736N00 (BX7401)	141	SEB01782X00	LP4823	²⁾ SEB01782000 (LP4823)	16
SEB01270	BX7611	²⁾ K031744N00 (BX7611)	141	SEB01783	LP4984	²⁾ SEB01783000 (LP4984)	16
SEB01273	AE4450		40	SEB01783000	LP4984		16
SEB01288	BX7516	²⁾ K031738N00 (BX7516)	141	SEB01784	LP4983	²⁾ SEB01784000 (LP4983)	16
SEB01315	-		153	SEB01784000	LP4983		16
SEB01316	-		153	SEB01784X00	LP4983	²⁾ SEB01784000 (LP4983)	16
SEB01326	BR5522	²⁾ I136836 (BR5522)	58	SEB01791	LP3974		13
SEB01333	AB2860		65	SEB01795000	LP3977	²⁾ K014799000 (LP3977)	13
SEB01387	KU1310	¹⁾ I117354 (KU1310)	67	SEB01795X00	LP3977	²⁾ K014799000 (LP3977)	13
SEB01388	KU1311	¹⁾ I117355 (KU1311)	67	SEB01799	LK3848	²⁾ K019284 (LK3848)	12
SEB01389	KU4124	¹⁾ K004231 (KU4124)	67	SEB01799000	LK3848	²⁾ K019284 (LK3848)	12
SEB01390	KU4128	¹⁾ K004230 (KU4128)	67	SEB01799X00	LK3848	²⁾ K019284 (LK3848)	12
SEB01392	LP4840	²⁾ SEB01392X00 (LP4840)	16	SEB01817	LK3846	²⁾ K000861000 (LK3846)	12
SEB01392X00	LP4840		16	SEB01819000	LK3840	¹⁾ K002141000 (LK3840)	12
SEB01395	BX7402	²⁾ K031737N00 (BX7402)	141	SEB01842	LK3994	²⁾ SEB01842000 (LK3994)	13
SEB01398	BX7612	²⁾ K031745N00 (BX7612)	141	SEB01842000	LK3994		13
SEB01430	LP4843		16	SIL68A	-		188
SEB01446	KU4128	¹⁾ K004230 (KU4128)	67	SIL68ASP	-		188
SEB01452	LP4827	¹⁾ SEB01455000 (LP4845)	16	SIL68B	-		188
SEB01455	LP4845	²⁾ SEB01455000 (LP4845)	16	SIL68BK	-		188
SEB01455000	LP4845		16	SM1A	-		208
SEB01485	LP4833	¹⁾ SEB01485X00 (LP4833)	16	SM1B	SM1B	²⁾ K022028N00 (SM1PLB)	49, 208
SEB01485X00	LP4833		16	SM2A	-		208
SEB01534	AE4232	¹⁾ I136133 (AE4232)	78	STK6736024	-		186
SEB01535	AE4233	²⁾ I136134 (AE4233)	78	T41333	SV1219	¹⁾ I136169 (SV1481)	198
SEB01537	AE4247	¹⁾ I136131 (AE4247)	77, 108	T47852	SV1219	¹⁾ I136169 (SV1481)	198
SEB01542	AB2863		65	T55704	EE1100	¹⁾ I94095 (EE1100)	31
SEB01545	LP4851	²⁾ SEB01545000 (LP4851)	16	T74772	EE4103	²⁾ I74772 (EE4103)	31
SEB01545000	LP4851		16	T84866	EE4104	¹⁾ I84866 (EE4104)	31
SEB01586	LK3833	²⁾ SEB01586000 (LK3833)	12	VA12A	-		31
SEB01586000	LK3833		12	VPC2T	-	²⁾ K028608 (DR4265)	38
SEB01588	LP4852		16	VPC3A	VPC3A	¹⁾ K000632 (DR4258)	38
SEB01597	LK3834	²⁾ SEB01597000 (LK3834)	12	VPC3L	VPC3L	²⁾ K000626 (DR4252)	38

Products in Part Number order
Produkte, nach Teilenummern geordnet

Classification des Produits par Numero
Prodotti ordinati per Codice

Part Number	Type Number	Replacement/Remplacé par Ersatz / Sostituito da	Page	Part Number	Type Number	Replacement/Remplacé par Ersatz / Sostituito da	Page
VPC4A	–		37	Z000991	–	²⁾ Z0009911	184
VPS38AIY	–		40	Z0009911	–		184
VPS40AAY	VPS40AAY	²⁾ K019907 (AE4644)	41	Z0010001	SN7021	¹⁾	180
VPS40CY	VPS40CY	²⁾ K019908 (AE4645)	41	Z0010002	SN7031	¹⁾	180
VPS41AY	VPS41AY	²⁾ K019904 (AE4641)	41	Z0010003	SN7021	¹⁾	180
VPS41BY	VPS41BY	²⁾ K019905 (AE4642)	41	Z0010004	SN7031	¹⁾	180
VPS41CY	VPS41CY	²⁾ K019906 (AE4643)	41	Z0010291	SN7022	¹⁾	180
VPS45A	VPS45A	²⁾ K019909 (AE4646)	41	Z0010292	SN7032	¹⁾	180
VPS45AY	VPS45AY	²⁾ K019909 (AE4646)	41	Z0010293	SN7022	¹⁾	180
VPS45C	VPS45C	²⁾ K019911 (AE4648)	41	Z0010294	SN7032	¹⁾	180
VPS45HY	–		40	Z0010671	SB6561	¹⁾	180
VPS45HYK	–		40	Z0010672	SB6571	¹⁾	180
VSR2A	VSR2A	²⁾ KX2000/1	62	Z0010911	SN7028	¹⁾	180
Y004245	BS8525	²⁾ K017121N00 (BS8525)	147	Z0010911AT		¹⁾	180
Y004246	BS8526	²⁾ K017122N00 (BS8526)	147	Z0010911DC		¹⁾	180
Z0001651	SB7501	¹⁾	180	Z0010912	SN7038	¹⁾	180
Z0001652	SB7511	¹⁾	180	Z0010912AT	–	¹⁾ Z0010912DC	180
Z000276	SB7829	¹⁾	180	Z0010912DC		¹⁾	181
Z000276M1	SB7829	¹⁾ Z0015731 (SB7861)	181	Z0010913	SN7028	¹⁾	181
Z000276M2	SB7829	¹⁾ Z0015731 (SB7861)	181	Z0010914	SN7038	¹⁾	181
Z000277	SB7839	¹⁾	180	Z0010961	SB7842	¹⁾	181
Z000277M1	SB7829	¹⁾ Z0015732	181	Z0010962	SB7852	¹⁾	181
Z000277M2	SB7839	¹⁾ Z0015732	181	Z0011451	SB6527	¹⁾	181
Z000557	–		184	Z0011451M1	SB6527	¹⁾ Z0011451 (SB6527)	180
Z000652	SB7688	¹⁾	180	Z0011452	SB6537	¹⁾	181
Z000652AT		¹⁾	180	Z0011452M1	SB6537	¹⁾ Z0011452 (SB6537)	180
Z000653	SB7698	¹⁾	180	Z0011471	SB7767	¹⁾	181
Z000653AT		¹⁾	180	Z0011471AT		¹⁾	181
Z000723	SN7020	¹⁾	180	Z0011472	SB7777	¹⁾	181
Z000723AT		¹⁾	180	Z0011472AT		¹⁾	181
Z000723DC	–	¹⁾ K002363DC	172	Z0011491	SB7801	¹⁾	181
Z000723M5	SN7020	¹⁾ Z000723 (SN7020)	180	Z0011491AT		¹⁾	181
Z000723M6	SN7020	¹⁾ Z000723 (SN7020)	180	Z0011492	SB7811	¹⁾	181
Z000724	SN7030	¹⁾	180	Z0011492AT		¹⁾	181
Z000724AT		¹⁾	180	Z0011541	SB6548	¹⁾	181
Z000724DC	–	¹⁾ K002364DC	172	Z0011542	SB6558	¹⁾	181
Z000724M5	SN7030	¹⁾ Z000724 (SN7030)	180	Z0011561	SB6528	¹⁾	181
Z000724M6	SN7030	¹⁾ Z000724 (SN7030)	180	Z0011561AT		¹⁾	181
Z000725	SN7020	¹⁾	180	Z0011562	SB6538	¹⁾	181
Z000725AT	–	¹⁾ Z000723AT	180	Z0011562AT		¹⁾	181
Z000726	SN7030	¹⁾	180	Z0011581	SB7762	¹⁾	181
Z000726AT	–	¹⁾ Z000724AT	180	Z0011582	SB7772	¹⁾	181
Z0009751	SB7859	¹⁾	180	Z0011891	SB6543	¹⁾	181
Z0009752	SB7869	¹⁾	180	Z0011892	SB6553	¹⁾	181
Z0009801	SB7858	¹⁾	180	Z0013571	SB7888	¹⁾	181
Z0009802	SB7868	¹⁾	180	Z0013571AT		¹⁾	181
Z000981	SB7824	¹⁾	180	Z0013572	SB7898	¹⁾	181
Z000982	SB7834	¹⁾	180	Z0013572AT		¹⁾	181

Products in Part Number order
Produkte, nach Teilenummern geordnet

Classification des Produits par Numero
Prodotti ordinati per Codice

Part Number	Type Number	Replacement/Remplacé par Ersatz / Sostituito da	Page	Part Number	Type Number	Replacement/Remplacé par Ersatz / Sostituito da	Page
Z0013591	SB7889	¹⁾	181	Z0017522AT		¹⁾	181
Z0013591AT		¹⁾	181	Z0017523	SB7800	¹⁾	181
Z0013591M1	SB7889	¹⁾ Z0013591 (SB7889)	181	Z0017523AT		¹⁾	181
Z0013591SAT		¹⁾	181	Z0017524	SB7810	¹⁾	181
Z0013592	SB7899	¹⁾	181	Z0017524AT		¹⁾	181
Z0013592AT		¹⁾	181	Z0017671	SB6548	¹⁾	181
Z0013592M1	SB7899	¹⁾ Z0013592 (SB7899)	181	Z0017672	SB6558	¹⁾	181
Z0013592SAT		¹⁾	181	Z0017951	SB7863	¹⁾	181
Z0013611	SN7040	¹⁾	181	Z0017952	SB7873	¹⁾	181
Z0013612	SN7050	¹⁾	181	Z0017971	SB6563	¹⁾	181
Z0013631	SN7041	¹⁾ K001654 (SN7041)	170	Z0017972	SB6573	¹⁾	181
Z0013632	SN7051	¹⁾ K001655 (SN7051)	170	Z002016	–		184
Z0014981M1	SB7167	¹⁾ K000262 (SB7189)	168	Z002017	–		184
Z0014982M1	SB7177	¹⁾ K000263 (SB7199)	168	Z0021001	SB7604	¹⁾	181
Z0015241	SB7601	¹⁾	181	Z0021001AT		²⁾	181
Z0015241AT		¹⁾	181	Z0021002	SB7614	¹⁾	181
Z0015242	SB7611	¹⁾	181	Z0021002AT		²⁾	181
Z0015242AT		¹⁾	181	Z0021021	SB7607	¹⁾	181
Z0015261	SB7602	¹⁾	181	Z0021021AT		¹⁾	181
Z0015261AT		¹⁾	181	Z0021022	SB7617	¹⁾	182
Z0015262	SB7612	¹⁾	181	Z0021022AT		¹⁾	182
Z0015262AT		¹⁾	181	Z0021041	SB7608	¹⁾	182
Z0015711	SB7860	¹⁾	181	Z0021041AT		²⁾	182
Z0015712	SB7870	¹⁾	181	Z0021042	SB7618	¹⁾	182
Z0015712AT		¹⁾	181	Z0021042AT		²⁾	182
Z0015731	SB7861	¹⁾	181	Z0021043	SB7608	¹⁾	182
Z0015732		¹⁾	181	Z0021044	SB7618	¹⁾	182
Z0015751	SB7862	¹⁾	181	Z0021081	SB7621	¹⁾	182
Z0015752	SB7872	¹⁾	181	Z0021081AT	–	¹⁾ K001164AT	169
Z001637	–		184	Z0021082	SB7631	¹⁾	182
Z001640	–	¹⁾ II39290F	184	Z0021082AT		¹⁾	182
Z0016511	SB6527	¹⁾	181	Z0021103	SB7168	¹⁾	182
Z0016511AT		¹⁾	181	Z0021103AT		²⁾	182
Z0016511M1	SB6527	¹⁾ Z0016511 (SB6527)	181	Z0021104	SB7178	¹⁾	182
Z0016512	SB6537	¹⁾	181	Z0021104AT		²⁾	182
Z0016512AT		¹⁾	181	Z0021121	SB7180	²⁾	182
Z0016512M1	SB6537	¹⁾ Z0016512 (SB6537)	181	Z0021121AT		¹⁾	182
Z0016513AT		¹⁾	181	Z0021122	SB7190	²⁾	182
Z0016514AT		¹⁾	181	Z0021122AT		¹⁾	182
Z0016571	SB7679	¹⁾	181	Z0021123	SB7180	¹⁾	182
Z0016571AT		¹⁾	181	Z0021124	SB7190	¹⁾	182
Z0016572	SB7689	¹⁾	181	Z0021141	SB7181	¹⁾	182
Z0016572AT		¹⁾	181	Z0021141AT		¹⁾	182
Z0017261	SN7042	¹⁾	181	Z0021141SAT		¹⁾	182
Z0017262	SN7052	¹⁾	181	Z0021141SC		¹⁾	182
Z0017521	SB7800	¹⁾	181	Z0021142	SB7191	¹⁾	182
Z0017521AT		¹⁾	181	Z0021142AT		¹⁾	182
Z0017522	SB7810	¹⁾	181	Z0021142SAT		¹⁾	182

Products in Part Number order
Produkte, nach Teilenummern geordnet

Classification des Produits par Numero
Prodotti ordinati per Codice

Part Number	Type Number	Replacement/Remplacé par Ersatz / Sostituito da	Page
Z0021142SC		¹⁾	182
Z0021161	SB7623	¹⁾	182
Z0021162	SB7633	¹⁾	182
Z0021181	SB7182	¹⁾	182
Z0021181AT		²⁾	182
Z0021182	SB7192	¹⁾	182
Z0021182AT		²⁾	182
Z0021221	SB7184	¹⁾	182
Z0021222	SB7194	¹⁾	182
Z0021241	SB7169	¹⁾	182
Z0021241AT		²⁾	182
Z0021242	SB7179	¹⁾	182
Z0021242AT		²⁾	182
Z0021243	SB7169	¹⁾	182
Z0021244	SB7179	¹⁾	182
Z0021261	SB7500	¹⁾	182
Z0021261AT		¹⁾	182
Z0021262	SB7510	¹⁾	182
Z0021262AT		¹⁾	182
Z0021281	SB7508		182
Z0021281AT		²⁾	182
Z0021282	SB7518		182
Z0021282AT		²⁾	182
Z0021301	SB7509	¹⁾	182
Z0021302	SB7519	¹⁾	182
Z0029181	SB7800	¹⁾ Z0017521 (SB7800)	181
Z0029182	SB7810	¹⁾ Z0017522 (SB7810)	181
Z0029183	SB7800	¹⁾ Z0017523 (SB7800)	181
Z0029184	SB7810	¹⁾ Z0017524 (SB7810)	181
Z002932	–	²⁾ K039546N50	99
Z005464	EZ1033		124
Z006407	–		184
Z006845	–		77
Z007887	–		124

Products in Type Number order
Produkte, nach Typnummern geordnet

Classification des Produits par Type
Prodotti ordinati per Catalogo

Type Number	Part Number	Replacement/Remplacé par Ersatz / Sostituito da	Page	Type Number	Part Number	Replacement/Remplacé par Ersatz / Sostituito da	Page
AB2761	I60363	¹⁾ 0481061005000	64	AE4105	I40405		71
AB2767	I77420	¹⁾ 0481061020000	64	AE4156	I69421	¹⁾ AE4185 (I81272)	40
AB2778	I77418	²⁾ 0481061005000	64	AE4162	I85512	²⁾	40
AB2783	I76739	¹⁾ 0481061219000	64	AE4162	I99810		40
AB2783	I79056	¹⁾ 0481061219000	64	AE4170	I77243		40
AB2793	I80275	¹⁾ 0481061220000	64	AE4185	I81272		40
AB2793	SEB00285	¹⁾ 0481061220000	64	AE4214	SEB00068	¹⁾ AE4232 (II36133)	78
AB2793	SEB00429	¹⁾ 0481061220000	64	AE4214	SEB01265	¹⁾ AE4232 (II36133)	78
AB2793	SEB00560	¹⁾ 0481061220000	64	AE4215	SEB00069	¹⁾ AE4233 (II36134)	78
AB2793	SEB00791		65	AE4230	II36128		77, 108
AB2795	I77618	²⁾ 0481061214000	64	AE4230	SEB00901	¹⁾ AE4230 (II36128)	77, 108
AB2797	I82919	¹⁾ 0481061220000	64	AE4232	II36133		78
AB2798	I83347	¹⁾ 0481061226000	64	AE4232	SEB00917	¹⁾ AE4232 (II36133)	78
AB2802	SEB00286	¹⁾ 0481061230000	64	AE4232	SEB01534	¹⁾ AE4232 (II36133)	78
AB2802	SEB00430	¹⁾ 0481061230000	64	AE4233	II36134		78
AB2802	SEB00786	²⁾ 0481061230000	64	AE4233	SEB00918	¹⁾ AE4233 (II36134)	78
AB2808	I97326	¹⁾ 0481061005000	64	AE4233	SEB01535	²⁾ AE4233 (II36134)	78
AB2816	I87674	¹⁾ 0481061230000	64	AE4247	II36129		77, 108
AB2835	I93262	¹⁾ 0481061219000	64	AE4247	II36131		77, 108
AB2838	SEB00875	²⁾ 0481061248000	64	AE4247	SEB01214	¹⁾ AE4247 (II36129)	77, 108
AB2851	II15334	¹⁾ AB2851 (II37151)	65	AE4247	SEB01537	¹⁾ AE4247 (II36131)	77, 108
AB2851	II37151		65	AE4254	I93219		71
AB2860	SEB01333		65	AE4261	II19803		78
AB2863	SEB01542		65	AE4262	II19802		78
AC155H	K009286		43	AE4264	II36055		78
AC155L	K008340		43	AE4265	II36061		78
AC155P	K007410		43	AE4311	K015380N00		77, 108
AC155R	K012528		44	AE4311	K015849N00		77, 108
AC156F	K035389N00		44	AE4311	K020123N00		77, 108
AC574AA	K008490		61	AE4370	K025700N00		77, 108
AC579BK	K008433		61	AE4371	K025699		108
AC597BJ	K016685		65	AE4371	K025699N00		77
AE1111	I66920		75	AE4405	I89408	²⁾ AE4405 (I89408000)	40
AE1114	I73682		75	AE4405	I89408000		40
AE1136	II30527		75	AE4427	II15587	²⁾ AE4427 (II15587000)	40
AE1139	K005161N00		75	AE4427	II15587000		40
AE1141	II36224	¹⁾ AE1141 (K008546)	108, 206	AE4428	II15588	²⁾ AE4428 (II15588000)	40
AE1141	K008546		108, 206	AE4428	II15588000		40
AE1141	K014117	²⁾ AE1141 (K035570N00)	206	AE4440	SEB01115		40
AE1141	K014849	¹⁾ AE1141 (K015384N00)	108, 206	AE4450	SEB01273		40
AE1141	K015384N00		108, 206	AE4452	II31480	²⁾ AE4452 (II31480000)	40
AE1141	K017224N00		108, 206	AE4452	II31480000		40
AE1141	K019882N00		108, 206	AE4459	II35525		40
AE1141	K035570N00		206	AE4463	K000055		40
AE2109	I99961		75	AE4502	II37679	¹⁾ AE4502 (K011931)	23, 24, 40
AE2110	II33261		75	AE4502	K011931		23, 24, 40
AE4102	I15658	²⁾	71	AE4503	II38677F		24, 40
AE4103	I17154		71	AE4503	II38677FM2	¹⁾ AE4503 (II38677F)	24, 40

Type Number	Part Number	Replacement/Remplacé par Ersatz / Sostituito da	Page	Type Number	Part Number	Replacement/Remplacé par Ersatz / Sostituito da	Page
AE4506	II36008	¹⁾ AE4506 (II38797F)	23, 40	BR4352	SEB00659		57
AE4506	II38797F		23, 40	BR4440	I99632	²⁾ BR4465 (II36826)	57
AE4510	II37680	²⁾ AE4510 (II37680N50)	23, 24, 40	BR4441	II15372	²⁾ BR4441 (II15372000)	57
AE4510	II37680N50		23, 24, 40	BR4441	II15372000		57
AE4516	K011932N50		24, 40	BR4452	II17352	²⁾ BR4467 (II36828)	57
AE4525	II37922		40	BR4455	II18784		57
AE4526	II39010FN50		40	BR4456	II18785		57
AE4527	II37463		24, 40	BR4457	II18786		57
AE4527	II37463M2	¹⁾ AE4527 (II37463)	24, 40	BR4465	II36826		57
AE4528	II37464N50		23, 24, 40	BR4467	II36828		57
AE4529	II38749F		23, 24	BR4468	II36829		57
AE4529	II38749F004		40	BR5407	I94299	²⁾	58
AE4529	II38749F0041	¹⁾ AE4529 (II38749F004)	40	BR5522	II36833	¹⁾ BR5522 (II36836)	58
AE4529	II38749FM2	¹⁾ AE4529 (II38749F)	23, 24	BR5522	II36836		58
AE4535	K001041	²⁾	40	BR5522	SEB01163	¹⁾ BR5522 (II36836)	58
AE4535	K025546		40	BR5522	SEB01326	²⁾ BR5522 (II36836)	58
AE4544	K026822		24, 40	BR5524	SEB01241		58
AE4603	II36011000		40	BR5530	II36818		58
AE4604	II36012000		40	BR5615	II14588		58
AE4605	II36650		40	BR5657	II37166		58
AE4605	K011255	²⁾	40	BR5658	II37167		58
AE4608	II37461N50		24, 41	BR9150	II15492	²⁾ K015676N00	83
AE4609	II37460		41	BR9151	II15687	²⁾ K015677N00	83
AE4611	II33856		41	BR9151	II15687R	²⁾ K015677N00	83
AE4612	II38801F		41	BR9152	II16278	²⁾ K015677N00	83
AE4613	II38802F		41	BR9154	II17776N00		83
AE4613	II38802FM1	¹⁾ AE4615 (II36150)	41	BR9156	II32612	²⁾ BR9154 (II17776N00)	83
AE4615	II36150		41	BR9157	II35462		83
AE4615	II39140F		41	BR9159	II40864F	²⁾ BR9154 (II17776N00)	83
AE4623	K000500		41	BR9163	II38659F		83
AE4625	K000516		41	BR9164	II38660F	²⁾	83
AE4629	K002147		24	BR9164	II38660FM2	¹⁾ BR9164 (II38660F)	83
AE4641	K019904		41	BR9165	II38661F	¹⁾ BR9164 (II38660F)	83
AE4642	K019905		41	BR9166	II40872F		83
AE4643	K019906		41	BR9180	II37086	¹⁾ BR9154 (II17776N00)	83
AE4644	K019907		41	BR9182	II38665F	²⁾ BR9154 (II17776N00)	83
AE4645	K019908		41	BR9190	II41053F		83
AE4646	K019909		41	BR9191	II41119F	²⁾ BR9154 (II17776N00)	83
AE4648	K019911		41	BR9231	II30522		92
AE4800	K002435	²⁾ AE4800 (K002435N50)	24, 41	BR9233	II37090N00		92
AE4800	K002435N50		24, 41	BR9234	II37091N00		89, 93
AE5101	II25351		70	BR9235	II40868F		93
AE5115	II75598		70	BS2306	K006510	²⁾ BS2306 (K006510N00)	132
AE5115	II82259	²⁾ AE5115 (II75598)	70	BS2306	K006510N00		132
AE5117	II74435	¹⁾ AE5115 (II75598)	70	BS2307	K006511	²⁾ BS2307 (K006511N00)	132
AE5131	K001349		70	BS2307	K006511N00		132
AE7110	K000701		192	BS2323	K031601N00		132
AE9125	II93544	¹⁾ EA1152 (II32611)	186	BS2402	K015581	²⁾ BS2402 (K017984)	132

Products in Type Number order
Produkte, nach Typnummern geordnet

Classification des Produits par Type
Prodotti ordinati per Catalogo

Type Number	Part Number	Replacement/Remplacé par Ersatz / Sostituito da	Page	Type Number	Part Number	Replacement/Remplacé par Ersatz / Sostituito da	Page
BS2402	K017984		132	BS3269	K010290		133
BS2406	K015583	²⁾ BS2406 (K017982)	132	BS3273	K003969	²⁾ BS3273 (K004286N00)	133
BS2406	K017982		132	BS3273	K004286	²⁾ BS3273 (K004286N00)	133
BS2407	K015584	²⁾ BS2407 (K017983)	132	BS3273	K004286N00		133
BS2407	K017983		132	BS3281	K004737	²⁾ BS3281 (K004737N00)	133
BS2408	K015582	²⁾ BS2408 (K017985)	132	BS3281	K004737N00		133
BS2408	K017985		132	BS3294	K019133		133
BS2409	K004763	²⁾ BS2409 (K018199)	132	BS3296	K028079N00		133
BS2409	K018199		132	BS3297	K028080N00		133
BS2410	K004764	²⁾ BS2410 (K018200)	132	BS3298	K029440N00		133
BS2410	K018200		132	BS3299	K029441N00		133
BS2429	K006648	²⁾ BS2429 (K006648N00)	132	BS3300	II14535		133
BS2429	K006648N00		132	BS3300	II14535000	²⁾ BS3300 (II14535)	133
BS2430	K006649	²⁾ BS2430 (K006649N00)	133	BS3301	II30614000	²⁾ BS3301 (K004146N00)	133
BS2430	K006649N00		133	BS3301	K004146	²⁾ KU4128 (K004152)	67
BS2437	K007799		132	BS3301	K004146N00		133
BS2443	K010666	²⁾	132	BS3313	II36969	²⁾ BS3313 (K003840)	133
BS2503	K006490	²⁾ BS2503 (K006490N00)	132	BS3313	K003840		133
BS2503	K006490N00		132	BS3315	II37140	²⁾ BS3315 (II37140000)	133
BS2504	II39205F	¹⁾ BS2504 (K002556)	132	BS3315	II37140000		133
BS2504	K002556		132	BS3316	II37315	²⁾ BS3316 (K015579)	133
BS2514	K001027	²⁾ BS2514 (K002843)	132	BS3316	K015579		133
BS2514	K002843		132	BS3317	II37316	²⁾ BS3317 (K015580)	133
BS2515	K001028	²⁾ BS2515 (K002844)	132	BS3317	K015580		133
BS2515	K002844		132	BS3321	II38111F		133
BS2516	K001603	²⁾ BS2523 (K006655N00)	132	BS3326	II38466F		133
BS2517	K001604	²⁾ BS2524 (K006656N00)	132	BS3326	II38466F000	¹⁾ BS3326 (II38466F)	133
BS2523	K006655	²⁾ BS2523 (K006655N00)	132	BS3332	K003841		133
BS2523	K006655N00		132	BS3335	II39218F		133
BS2524	K006656	²⁾ BS2524 (K006656N00)	132	BS3336	II39374F		133
BS2524	K006656N00		132	BS3337	II39375F		133
BS2546	K016480		132	BS3350	II15229		133
BS2547	K016481		132	BS3350	II15229000	²⁾ BS3350 (II15229)	133
BS3155	K006339		132	BS3350	II16229	¹⁾ BS3350 (II15229)	133
BS3201	II36967	²⁾ BS3201 (K008766)	133	BS3354	II36778	²⁾ BS3354 (K003030)	133
BS3201	K008766		133	BS3354	K003030		133
BS3207	II39193F	¹⁾ BS3207 (K008768)	133	BS3358	II38527F		133
BS3207	K008768		133	BS3362	II39199F	¹⁾ BS3362 (K003031)	133
BS3212	K006506	²⁾ BS3212 (K006506N00)	133	BS3362	K003031		133
BS3212	K006506N00		133	BS3379	K028697N00		133
BS3213	K006507	²⁾ BS3213 (K006507N00)	133	BS3401	K003991	¹⁾ BS3401 (K004171N00)	133
BS3213	K006507N00		133	BS3401	K004171	²⁾ BS3401 (K004171N00)	133
BS3250	II32963000	²⁾ BS3250 (K003968N00)	133	BS3401	K004171N00		133
BS3250	K003968	²⁾ BS3250 (K003968N00)	133	BS3402	II30616	²⁾ BS3402 (K005086)	133
BS3250	K003968N00		133	BS3402	K005086		133
BS3251	II31782		133	BS3403	II30617	²⁾ BS3403 (K005087)	133
BS3251	II31782000	¹⁾ BS3251 (II31782)	133	BS3403	K005087		133
BS3269	II39196F	¹⁾ BS3269 (K010290)	133	BS3404	II31098		133

Products in Type Number order
Produkte, nach Typnummern geordnet

Classification des Produits par Type
Prodotti ordinati per Catalogo

Type Number	Part Number	Replacement/Remplacé par Ersatz / Sostituito da	Page	Type Number	Part Number	Replacement/Remplacé par Ersatz / Sostituito da	Page
BS3404	II31098000	²⁾ BS3404 (II31098)	133	BS3475	K006654N00		134
BS3409	K003992	²⁾ BS3409 (K004172N00)	133	BS3501	K002623	²⁾ BS3501 (K002623N00)	134
BS3409	K004172	²⁾ BS3409 (K004172N00)	133	BS3501	K002623N00		134
BS3409	K004172N00		133	BS3501	K002851	¹⁾ BS3501 (K002623N00)	134
BS3410	K003993	²⁾ BS3410 (K004207N00)	133	BS3507	II19019	²⁾ BS3507 (K015585)	134
BS3410	K004207	²⁾ BS3410 (K004207N00)	133	BS3507	K015585		134
BS3410	K004207N00		133	BS3507	K018266		134
BS3411	K002849	²⁾ BS3411 (K004209N00)	133	BS3511	II31105	²⁾ BS3511 (K015586)	134
BS3411	K004208	²⁾ BS3411 (K004209N00)	133	BS3511	K015586		134
BS3411	K004209	²⁾ BS3411 (K004209N00)	133	BS3511	K018267		134
BS3411	K004209N00		133	BS3514	II32597N00	²⁾ BS3514 (K002624N00)	134
BS3412	K002850	²⁾ BS3412 (K004211N00)	133	BS3514	K002624	²⁾ BS3514 (K002624N00)	134
BS3412	K004211	²⁾ BS3412 (K004211N00)	133	BS3514	K002624N00		134
BS3412	K004211N00		133	BS3514	K003996	²⁾ BS3514 (K003996N00)	134
BS3413	K003994	²⁾ BS3413 (K003994N00)	133	BS3514	K003996N00		134
BS3413	K003994N00		133	BS3515	II32598N00	²⁾ BS3515 (K002720N00)	134
BS3414	K003995	²⁾ BS3414 (K003995N00)	133	BS3515	K002720	²⁾ BS3515 (K002720N00)	134
BS3414	K003995N00		133	BS3515	K002720N00		134
BS3415	II32710		133	BS3515	K003997	²⁾ BS3515 (K003997N00)	134
BS3423	K003020		134	BS3515	K003997N00		134
BS3424	II37865	¹⁾ BS2429 (K006648N00)	132	BS3516	II32599	²⁾ BS3516 (K005211)	134
BS3434	II38413F	²⁾ BS3434 (K004485N00)	134	BS3516	II32599N00	²⁾ BS3516 (K002721N00)	134
BS3434	II38413FN00	²⁾ BS3434 (K004485N00)	134	BS3516	K002721	²⁾ BS3516 (K002721N00)	134
BS3434	K004485	²⁾ BS3434 (K004485N00)	134	BS3516	K002721N00		134
BS3434	K004485N00		134	BS3516	K002852	²⁾ BS3516 (K002721N00)	134
BS3435	II38414F	²⁾ BS3435 (K004486N00)	134	BS3516	K005211	²⁾	134
BS3435	II38414FN00	²⁾ BS3435 (K004486N00)	134	BS3521	K015588	²⁾ BS3521 (K017944)	134
BS3435	K004486	²⁾ BS3435 (K004486N00)	134	BS3521	K017944		134
BS3435	K004486N00		134	BS3522	II32172	²⁾ BS3522 (K005212)	134
BS3436	II38528F		134	BS3522	II32172N00	²⁾ BS3522 (K002722N00)	134
BS3436	K005814		134	BS3522	K002722	²⁾ BS3522 (K002722N00)	134
BS3441	II39201F	¹⁾ BS3441 (K003021)	134	BS3522	K002722N00		134
BS3441	K003021		134	BS3522	K002853	²⁾ BS3522 (K002722N00)	134
BS3450	II14540		134	BS3522	K005212	²⁾	134
BS3451	II18850		134	BS3526	II32723	²⁾ BS3526 (K015591)	134
BS3452	II18886		134	BS3526	K015591		134
BS3453	II31099		134	BS3528	II33903	²⁾ BS3528 (K015592)	134
BS3458	II36780	¹⁾ BS3458 (K003012)	134	BS3528	K015592		134
BS3458	K003012		134	BS3532	II36781	¹⁾ BS3532 (K002420)	134
BS3462	II38529F		134	BS3532	K002420		134
BS3467	II39203	¹⁾ BS3467 (K003013)	134	BS3536	II37133	²⁾ BS3536 (K015589)	134
BS3467	II39203F	¹⁾ BS3467 (K003013)	134	BS3536	K015589		134
BS3467	K003013		134	BS3537	II37134	²⁾ BS3537 (K015590)	134
BS3471	K001214		134	BS3537	K015590		134
BS3472	K001215		134	BS3538	II37127		134
BS3474	K006653	²⁾ BS3474 (K006653N00)	134	BS3538	K003170		134
BS3474	K006653N00		134	BS3547	K005817		134
BS3475	K006654	²⁾ BS3475 (K006654N00)	134	BS3800	K015833	²⁾	134

Products in Type Number order
Produkte, nach Typnummern geordnet

Classification des Produits par Type
Prodotti ordinati per Catalogo

Type Number	Part Number	Replacement/Remplacé par Ersatz / Sostituito da	Page	Type Number	Part Number	Replacement/Remplacé par Ersatz / Sostituito da	Page
BS3800	K017986		134	BS8330	K004876	²⁾ BS8330 (K004876N00)	145
BS3801	K015834	²⁾	134	BS8330	K004876N00		145
BS3801	K017987		135	BS8331	K004877	²⁾ BS8331 (K004877N00)	145
BS3806	K017988		135	BS8331	K004877N00		145
BS3810	K025367		135	BS8332	K005486	²⁾ BS8332 (K007648)	145
BS3811	K031597N00		135	BS8332	K007648		145
BS3812	K031598N00		135	BS8333	K005487	²⁾ BS8333 (K007649)	145
BS4502	K028614N00		135	BS8333	K007649		145
BS4503	K031532N00		135	BS8334	K005488	¹⁾ BS8334 (K007653)	145
BS4504	K031533N00		135	BS8334	K007653		145
BS6408	K026887N00		145	BS8335	K005489	¹⁾ BS8335 (K007654)	145
BS6409	K026888N00		145	BS8335	K007654		145
BS6411	K028699N00		145	BS8337	K007045	²⁾ BS8337 (K007045000)	146
BS6412	K028700N00		145	BS8337	K007045000		146
BS6413	K028809N00		145	BS8338	K007049	²⁾ BS8338 (K007049N00)	146
BS6414	K028810N00		145	BS8338	K007049N00		146
BS6415	K029229N00		145	BS8350	K016484		146
BS6416	K029230N00		145	BS8351	K016485		146
BS6421	K038828N00		145	BS8392	K014919		146
BS6422	K038829N00		145	BS8393	K014920		146
BS7304	II38524F	²⁾ BS7304 (K026894N00)	151	BS8402	K004044	²⁾ BS8402 (K004044000)	146
BS7304	K026894N00		151	BS8402	K004044000		146
BS7309	II39355F	²⁾ BS7309 (K026896N00)	151	BS8403	K004045	²⁾ BS8403 (K004045000)	146
BS7309	K026896N00		151	BS8403	K004045000		146
BS7312	II39933F	²⁾ BS7312 (K026898N00)	151	BS8413	K001031	¹⁾ BS8413 (K007668)	146
BS7312	K026898N00		151	BS8413	K007668		146
BS7313	II39934F	²⁾ BS7313 (K026899N00)	151	BS8414	K001032	²⁾ BS8414 (K007669)	146
BS7313	K026899N00		151	BS8414	K007669		146
BS7318	K001946	²⁾ BS7318 (K026900N00)	151	BS8415	K001238	²⁾ BS8415 (K007670)	146
BS7318	K026900N00		151	BS8415	K007670		146
BS7319	K001947	²⁾ BS7319 (K026901N00)	151	BS8420	K001123	¹⁾ BS8420 (K007657)	146
BS7319	K026901N00		151	BS8420	K007657		146
BS7351	II38525F	²⁾ BS7351 (K026903N00)	151	BS8421	K001124	¹⁾ BS8421 (K007658)	146
BS7351	K026903N00		151	BS8421	K007658		146
BS7355	K001962	²⁾ BS7355 (K026904N00)	151	BS8425	K001761	¹⁾ BS8425 (K007130000)	146
BS7355	K026904N00		151	BS8426	K001970	¹⁾ BS8426 (K007677)	146
BS7356	K001963	²⁾ BS7356 (K026905N00)	151	BS8426	K007677		146
BS7356	K026905N00		151	BS8426	K010024N00		146
BS8263	K031451N00		145	BS8427	K001971	¹⁾ BS8427 (K007678)	146
BS8264	K031469N00		145	BS8427	K007678		146
BS8312	II40309F	²⁾	145	BS8427	K010025N00		146
BS8316	K000976		145	BS8428	K010026N00		146
BS8317	K000977		145	BS8429	K010027N00		146
BS8323	K001899		145	BS8430	K002200	²⁾ BS8430 (K002200000)	146
BS8328	K002097	¹⁾ BS8328 (K007655)	145	BS8430	K002200000		146
BS8328	K007655		145	BS8431	K002201	²⁾ BS8431 (K002201000)	146
BS8329	K002098	¹⁾ BS8329 (K007656)	145	BS8431	K002201000		146
BS8329	K007656		145	BS8434	K002955	²⁾ BS8434 (K007675)	146

Products in Type Number order
Produkte, nach Typnummern geordnet

Classification des Produits par Type
Prodotti ordinati per Catalogo

Type Number	Part Number	Replacement/Remplacé par Ersatz / Sostituito da	Page	Type Number	Part Number	Replacement/Remplacé par Ersatz / Sostituito da	Page
BS8434	K007675		146	BS8544	K005059	²⁾ BS8544 (K007684)	147
BS8435	K002956	²⁾ BS8435 (K007676)	146	BS8544	K007684		147
BS8435	K007676		146	BS8545	K005060	²⁾ BS8545 (K007685)	147
BS8436	K004682		146	BS8545	K007685		147
BS8437	K004683		146	BS8548	K005582N00		147
BS8450	II40500F		146	BS8549	K005583N00		147
BS8452	K000699		146	BS8550	K014686		147
BS8453	K000700		146	BS8551	K014687		147
BS8458	K007130	²⁾ BS8458 (K007130000)	146	BS8552	K014688		147
BS8458	K007130000		146	BS8559	K029059N00		147
BS8459	K007131	²⁾ BS8459 (K007131N00)	146	BS8560	K029501N00		147
BS8459	K007131N00		146	BS8561	K029502N00		147
BS8460	K007138	²⁾ BS8460 (K007138N00)	146	BS8562	K039066N00		147
BS8460	K007138N00		146	BS8563	K039067N00		147
BS8461	K007139	²⁾ BS8461 (K007139N00)	146	BS9082	K002972	²⁾ BS9082 (K007633)	147
BS8461	K007139N00		146	BS9082	K007633		147
BS8472	K010964N00		146	BS9083	K001436	²⁾ BS9083 (K007631)	147
BS8473	K010965N00		146	BS9083	K007631		147
BS8482	K013837		146	BS9084	K001437	¹⁾ BS9083 (K007631)	147
BS8483	K013838		146	BS9084	K007632		147
BS8484	K026632		146	BS9084	K007632000	¹⁾ BS9084 (K007632)	147
BS8485	K038830N00		146	BS9086	K001029	¹⁾ BS9086 (K007629)	147
BS8500	II38470F000	²⁾ BS8500 (K017119N00)	146	BS9086	K007629		147
BS8500	K017119N00		146	BS9087	K001030	¹⁾ BS9087 (K007630)	147
BS8501	II38471F000	²⁾ BS8501 (K017120N00)	146	BS9087	K007630		147
BS8501	K017120N00		146	BS9092	II38488F	²⁾ BS9092 (K007625)	147
BS8506	II38547F		146	BS9092	K007625		147
BS8507	K007135	²⁾ BS8507 (K007135000)	146	BS9093	K007626		147
BS8507	K007135000		146	BS9177	K007038	²⁾ BS9177 (K007038N00)	147
BS8508	K007136	²⁾ BS8508 (K007136000)	147	BS9177	K007038N00		147
BS8508	K007136000		147	BS9178	K007039	²⁾ BS9178 (K007039000)	147
BS8510	K011682		147	BS9178	K007039000		147
BS8516	II38922F		147	BS9179	K003676	¹⁾ BS9179 (K007640)	147
BS8517	II39219F		147	BS9179	K007640		147
BS8517	II39219F000	²⁾ BS8517 (II39219F)	147	BS9180	K003677	¹⁾ BS9180 (K007641)	147
BS8518	II39220F		147	BS9180	K007641		147
BS8519	II39614F		147	BS9193	II33520	¹⁾ BS9193 (II37520)	147
BS8520	II39929F	²⁾ BS8520 (II39929FN00)	147	BS9193	II37520		147
BS8520	II39929FN00		147	BS9251	K011359		147
BS8521	II39930F	²⁾ BS8521 (II39930FN00)	147	BS9252	K011360		147
BS8521	II39930FN00		147	BS9253	II32590	¹⁾ BS9253 (K004017N00)	147
BS8522	II39958F	²⁾ BS8519 (II39614F)	147	BS9253	K004017	²⁾ BS9253 (K004017N00)	147
BS8525	K017121N00		147	BS9253	K004017N00		147
BS8525	Y004245	²⁾ BS8525 (K017121N00)	147	BS9265	K000978		147
BS8526	K017122N00		147	BS9265	K000978000	¹⁾ BS9265 (K000978)	147
BS8526	Y004246	²⁾ BS8526 (K017122N00)	147	BS9266	K000979		147
BS8540	K001605	¹⁾ BS8507 (K007135000)	146	BS9266	K000979000	¹⁾ BS9266 (K000979)	147
BS8541	K001606	¹⁾ BS8508 (K007136000)	147	BS9269	K001902		147

Products in Type Number order
Produkte, nach Typnummern geordnet

Classification des Produits par Type
Prodotti ordinati per Catalogo

Type Number	Part Number	Replacement/Remplacé par Ersatz / Sostituito da	Page	Type Number	Part Number	Replacement/Remplacé par Ersatz / Sostituito da	Page
BS9270	K001903		147	BS9377	II38496F		148
BS9272	K003678	¹⁾ BS9272 (K007644)	147	BS9377	II38496F000	¹⁾ BS9377 (II38496F)	148
BS9272	K007644	²⁾	147	BS9378	II38497F		148
BS9273	K003679	¹⁾ BS9273 (K007645)	148	BS9379	II38465F		148
BS9273	K007645	²⁾	148	BS9390	II37138	²⁾ BS9390 (II37138000)	148
BS9283	K001976		148	BS9390	II37138000		148
BS9287	II38428F		148	BS9391	II37139	²⁾ BS9391 (II37139000)	148
BS9296	II33648	¹⁾ BS9296 (K007642)	148	BS9391	II37139000		148
BS9296	K007642		148	BS9395	II32159	²⁾ BS9395 (K007646)	148
BS9296	K007642000	²⁾ BS9296 (K007642)	148	BS9395	K007646		148
BS9297	II31783		148	BS9395	K007646000	²⁾ BS9395 (K007646)	148
BS9297	II31783000	²⁾ BS9297 (II31783)	148	BS9396	II32160	¹⁾ BS9396 (K007647)	148
BS9305	II32600	²⁾ BS9305 (K002855N00)	148	BS9396	K007647		148
BS9305	K002855	²⁾ BS9305 (K002855N00)	148	BS9396	K007647000	²⁾ BS9396 (K007647)	148
BS9305	K002855N00		148	BS9397	II31227		148
BS9306	II32601	²⁾ BS9306 (K002854N00)	148	BS9397	II31227000	¹⁾ BS9397 (II31227)	148
BS9306	K002854	²⁾ BS9306 (K002854N00)	148	BS9398	II18224		148
BS9306	K002854N00		148	BS9404	II31407	²⁾ BS9404 (II31407000)	148
BS9308	II32700	²⁾ BS9308 (K002859N00)	148	BS9404	II31407000		148
BS9308	K002859	²⁾ BS9308 (K002859N00)	148	BS9405	II32604	²⁾ BS9405 (K004033N00)	148
BS9308	K002859N00		148	BS9405	K004033	²⁾ BS9405 (K004033N00)	148
BS9311	II32175000	²⁾ BS9311 (K002858N00)	148	BS9405	K004033N00		148
BS9311	K002858	²⁾ BS9311 (K002858N00)	148	BS9406	II32605	²⁾ BS9406 (K004034N00)	148
BS9311	K002858N00		148	BS9406	K004034	²⁾ BS9406 (K004034N00)	148
BS9320	II33767000	²⁾ BS9320 (K002857N00)	148	BS9406	K004034N00		148
BS9320	K002857	²⁾ BS9320 (K002857N00)	148	BS9411	II32701	¹⁾ BS9411 (K002861N00)	148
BS9320	K002857N00		148	BS9411	K002861	²⁾ SB6400R (K002874)	172
BS9321	II33770000	²⁾ BS9321 (K002856N00)	148	BS9411	K002861N00		148
BS9321	K002856	²⁾ BS9321 (K002856N00)	148	BS9412	II32702	¹⁾ BS9412 (K002860N00)	148
BS9321	K002856N00		148	BS9412	K002860	²⁾ BS9412 (K002860N00)	148
BS9338	II38467F		148	BS9412	K002860N00		148
BS9350	K007055	²⁾ BS9350 (K007055N00)	148	BS9418	K007086	²⁾ BS9418 (K007086N00)	148
BS9350	K007055N00		148	BS9418	K007086N00		148
BS9351	K007054	²⁾ BS9351 (K007054N00)	148	BS9419	K007087	²⁾ BS9419 (K007087N00)	148
BS9351	K007054N00		148	BS9419	K007087N00		148
BS9354	II33999	²⁾ BT4800 (K009968)	150	BS9421	II34000		148
BS9355	II34184	²⁾ BT4801 (K009969)	150	BS9424	II34185		148
BS9356	II35736		148	BS9429	K012376N00		148
BS9356	II35736000	¹⁾ BS9356 (II35736)	148	BS9433	II36962	²⁾ BS9433 (K007661)	148
BS9362	K000909		148	BS9433	K007661		148
BS9363	K000910		148	BS9434	II36972	²⁾ BS9434 (K007662)	148
BS9368	K001999	²⁾ BT4700 (K010006)	150	BS9434	II36972F	¹⁾ BS9434 (K007662)	148
BS9369	K002000	²⁾ BT4701 (K010007)	150	BS9434	K007662		148
BS9370	K002002		148	BS9437	II37266	²⁾ BS9437 (K004042N00)	149
BS9371	K002003		148	BS9437	K004042	²⁾ BS9437 (K004042N00)	149
BS9373	II39213F		148	BS9437	K004042N00		149
BS9373	II39213FN00	²⁾ BS9373 (II39213F)	148	BS9438	II37267	²⁾ BS9438 (K004043N00)	149
BS9374	II39212FN00		148	BS9438	K004043	²⁾ BS9438 (K004043N00)	149

Products in Type Number order
Produkte, nach Typnummern geordnet

Classification des Produits par Type
Prodotti ordinati per Catalogo

Type Number	Part Number	Replacement/Remplacé par Ersatz / Sostituito da	Page	Type Number	Part Number	Replacement/Remplacé par Ersatz / Sostituito da	Page
BS9438	K004043N00		149	BS9508	K004051	²⁾ BS9508 (K004051000)	149
BS9458	II34389		149	BS9508	K004051000		149
BS9461	II37906		149	BS9509	II32174000	²⁾ BS9509 (K004053000)	149
BS9462	II38116F	²⁾ BS9462 (K007659)	149	BS9509	K004053	²⁾ BS9509 (K004053000)	149
BS9462	K007659		149	BS9509	K004053000		149
BS9466	K014922		149	BS9510	II33679	²⁾ BS9510 (K018094N00)	149
BS9467	K014923		149	BS9510	II33679000	²⁾ BS9510 (K018094N00)	149
BS9468	II39613F		149	BS9510	K018094	²⁾ BS9510 (K018094N00)	149
BS9471	II38124F		149	BS9510	K018094N00		149
BS9476	II38408F		149	BS9514	II33062000	²⁾ BS9514 (K004047N00)	149
BS9476	K004074		149	BS9514	K004047	²⁾ BS9514 (K004047N00)	149
BS9478	K004075		149	BS9514	K004047N00		149
BS9479	II38533F		149	BS9517	II33996	¹⁾ BS8519 (II39614F)	147
BS9480	II38551F	¹⁾ BS9480 (K004040N00)	149	BS9520	II34388		149
BS9480	K004040	²⁾ BS9480 (K004040N00)	149	BS9527	II34198	²⁾ BS9527 (K017123N00)	149
BS9480	K004040N00		149	BS9527	K017123N00		149
BS9481	II38552F	¹⁾ BS9481 (K004041N00)	149	BS9534	II37282		149
BS9481	K004041	²⁾ BS9481 (K004041N00)	149	BS9535	II37468		149
BS9481	K004041N00		149	BS9535	K007683		149
BS9482	II38568F	²⁾ BS9482 (K007665)	149	BS9536	II37747	²⁾ BS9536 (II37747000)	149
BS9482	K007665		149	BS9536	II37747000		149
BS9483	II38569F	²⁾ BS9483 (K007666)	149	BS9541	II38085		149
BS9483	K007666		149	BS9543	K011452	²⁾ BS9543 (K011452000)	149
BS9486	II38599F		149	BS9543	K011452000		149
BS9488	II39575F	¹⁾ BS8460 (K007138N00)	146	BS9544	K011453		149
BS9489	II39576F	¹⁾ BS8461 (K007139N00)	146	BS9563	K010566		149
BS9491	II39668F	¹⁾ BS9491 (K004031000)	149	BS9573	K013772		149
BS9491	K004031	²⁾ BS9491 (K004031000)	149	BS9574	K013773		150
BS9491	K004031000		149	BS9580	K015762		150
BS9492	II39669F	¹⁾ BS9492 (K004032000)	149	BT4700	K010006		150
BS9492	K004032	²⁾ BS9492 (K004032000)	149	BT4701	K010007		150
BS9492	K004032000		149	BT4800	K009968		150
BS9497	II40310F	²⁾	149	BT4801	K009969		150
BS9498	II40311F	²⁾	149	BT4802	K010002		150
BS9500	II32608	¹⁾ BS9500 (K004050000)	149	BT4803	K010003		150
BS9500	K004050	²⁾ BS9500 (K004050000)	149	BT4804	K010004		150
BS9500	K004050000		149	BT4805	K010005		150
BS9502	II32703	²⁾ BS9502 (K004052N00)	149	BT5708	K018155		150
BS9502	K004052	²⁾ BS9502 (K004052N00)	149	BT5709	K018158		150
BS9502	K004052N00		149	BT5800	K009970		150
BS9504	II32609	²⁾ BS9504 (II32609000)	149	BT5801	K009971		150
BS9504	II32609000		149	BT5802	K010119		150
BS9505	II32697	²⁾ BS9505 (II32697000)	149	BT5803	K010121		150
BS9505	II32697000		149	BX3540	K045276N00		126
BS9507	II32161000	²⁾ BS9507 (K004046N00)	149	BX7401	K031736N00		141
BS9507	K004046	²⁾ BS9507 (K004046N00)	149	BX7401	SEB01269	²⁾ BX7401 (K031736N00)	141
BS9507	K004046N00		149	BX7402	K031737N00		141
BS9508	II32173N00	²⁾ BS9508 (K004051000)	149	BX7402	SEB01395	²⁾ BX7402 (K031737N00)	141

Products in Type Number order
Produkte, nach Typnummern geordnet

Classification des Produits par Type
Prodotti ordinati per Catalogo

Type Number	Part Number	Replacement/Remplacé par Ersatz / Sostituito da	Page	Type Number	Part Number	Replacement/Remplacé par Ersatz / Sostituito da	Page
BX7414	K037983N00		141	BY9104	II18524000		144
BX7514	K031748N00		141	BY9153	II18525	²⁾ BY9153 (II18525000)	144
BX7514	SEB01267	²⁾ BX7514 (K031748N00)	141	BY9153	II18525000		144
BX7515	K037970N00		141	BY9154	II18526	²⁾ BY9154 (II18526000)	144
BX7515	SEB01268	²⁾ BX7515 (K037970N00)	141	BY9154	II18526000		144
BX7516	K031738N00		141	BY9200	II16575	²⁾ BY9200 (II16575000)	144
BX7516	SEB01288	²⁾ BX7516 (K031738N00)	141	BY9200	II16575000		144
BX7523	II36944	²⁾ BX7523 (K031739N00)	141	BY9201	II16576	²⁾ BY9201 (II16576000)	144
BX7523	K031739N00		141	BY9201	II16576000		144
BX7525	II36946	²⁾ BX7525 (K031740N00)	141	BY9205	II17468		142
BX7525	K031740N00		141	BY9223	K004056	²⁾	144
BX7542	K037810N00		141	BY9224	K004057	²⁾	144
BX7543	K038535N00		141	BY9227	K004058	²⁾	144
BX7545	K038537N00		141	BY9228	K004059	²⁾	144
BX7611	K031744N00		141	BY9230	II39595F		142
BX7611	SEB01270	²⁾ BX7611 (K031744N00)	141	BY9233	K003845	²⁾ BY9233 (K003845000)	142
BX7612	K031745N00		141	BY9233	K003845000		142
BX7612	SEB01398	²⁾ BX7612 (K031745N00)	141	BY9235	K003847	²⁾ BY9235 (K003847000)	142
BX7618	K038538N00		141	BY9235	K003847000		142
BX9400	II37274		139	BY9236	K003865	²⁾ BY9236 (K003865000)	142
BX9500	II31409		139	BY9236	K003865000		142
BX9551	K002607		139	BY9237	K003868	²⁾ BY9237 (K003868000)	142
BX9553	K002609		139	BY9237	K003868000		142
BY3156	I98796	¹⁾ EF105BY	129	BY9238	K003869	²⁾ BY9238 (K003869000)	142
BY3251	I82038	¹⁾ 0482023504000	131	BY9238	K003869000		142
BY3251	I86378	¹⁾ 0482023504000	131	BY9239	K004077		142
BY3303	I86291		130	BY9260	II19750		142
BY3359	K004330	²⁾	130	BY9263	II30393	²⁾ BY9263 (II30393000)	144
BY3404	I98802	¹⁾ EF201LY	130	BY9263	II30393000		144
BY3406	II37730		130	BY9272	II39358F		142
BY3408	II39666F		130	BY9276	K001057		142
BY3454	I98806	¹⁾ EF221LY	130	BY9278	K001713	¹⁾ BY9278 (K014029)	142
BY3505	I98810	¹⁾ EF241LY	130	BY9278	K014029		142
BY3509	II37731		130	BY9279	K001714	¹⁾ BY9279 (K014031)	142
BY3510	K002171		130	BY9279	K014031		142
BY7109	I83737	¹⁾ BY9103 (II18523000)	144	BY9282	K019976N00		144
BY7115	I88637	¹⁾ BY9104 (II18524000)	144	BY9283	K019977N00		144
BY7151	I82046	¹⁾ BY9154 (II18526000)	144	BY9287	K031711N00		142
BY7151	I86321	¹⁾ BY9154 (II18526000)	144	BY9300	K014027	²⁾ BY9300 (K014027000)	142
BY7152	I83738	¹⁾ BY9153 (II18525000)	144	BY9300	K014027000		142
BY7152	I86322	¹⁾ BY9153 (II18525000)	144	BY9303	K014028	²⁾ BY9303 (K014028000)	143
BY7203	I82047	¹⁾ BY9200 (II16575000)	144	BY9303	K014028000		143
BY7203	I86323	¹⁾ BY9200 (II16575000)	144	BY9305	K014026	²⁾ BY9305 (K014026000)	143
BY7214	I83739	¹⁾ BY9201 (II16576000)	144	BY9305	K014026000		143
BY7214	I86324	¹⁾ BY9201 (II16576000)	144	BY9321	II35117	²⁾ BY9321 (II35117000)	144
BY9103	II18523	²⁾ BY9103 (II18523000)	144	BY9321	II35117000		144
BY9103	II18523000		144	BY9322	II36724	²⁾ BY9322 (K003964N00)	144
BY9104	II18524	²⁾ BY9104 (II18524000)	144	BY9322	K003964	²⁾ BY9322 (K003964N00)	144

Products in Type Number order
Produkte, nach Typnummern geordnet

Classification des Produits par Type
Prodotti ordinati per Catalogo

Type Number	Part Number	Replacement/Remplacé par Ersatz / Sostituito da	Page	Type Number	Part Number	Replacement/Remplacé par Ersatz / Sostituito da	Page
BY9322	K003964N00		144	BZ3480	K045268N00		127
BY9323	II36725	²⁾ BY9323 (K004064N00)	144	BZ3481	K045269N00		127
BY9323	K004064	²⁾ BY9323 (K004064N00)	144	BZ3490	K045275N00		127
BY9323	K004064N00		144	BZ3491	K045274N00		127
BY9328	II39229F	¹⁾ BY9328 (K014032)	143	BZ3537	K045257N00		127
BY9328	K014032		143	BZ3538	K045258N00		127
BY9328	K014032000	²⁾ BY9328 (K014032)	143	BZ3555	K045265N00		127
BY9331	K001059	¹⁾ BY9331 (K014030)	143	BZ3573	K045270N00		127
BY9331	K014030		143	BZ3588	K045272N00		127
BY9334	K019993N00		144	BZ3589	K045273N00		127
BY9335	K019994N00		144	BZ3645	I76260		136
BY9338	K020814N00		144	BZ3713	I76261		136
BY9340	K021178N00		144	BZ5410	I88263		136
BY9341	K021179N00		144	BZ6427	I82454		140
BY9367	K001715	²⁾	143	BZ7408	SEB00318	¹⁾ BX9400 (II37274)	139
BY9368	K003924		143	BZ7408	SEB00425	¹⁾ BX9400 (II37274)	139
BY9368	K003924000	²⁾ BY9368 (K003924)	143	BZ7420	I80267	¹⁾ BX9400 (II37274)	139
BY9369	K011981		143	BZ7421	SEB00321	¹⁾ BX9400 (II37274)	139
BY9370	K011996		143	BZ7421	SEB00426	¹⁾ BX9400 (II37274)	139
BY9371	K011997		143	BZ7451	SEB00510	¹⁾ BX9400 (II37274)	139
BY9372	K012717		143	BZ7455	SEB00601	¹⁾ BX9400 (II37274)	139
BY9408	II32135		143	BZ7564	I90845	¹⁾ BZ7564 (II14008)	139
BY9411	II37312		143	BZ7564	II14008		139
BY9412	II37313		143	BZ7567	I90846	¹⁾ BZ7567 (II14009)	139
BY9451	II17755		143	BZ7567	II14009		139
BY9452	II18692		143	BZ7570	I90912	¹⁾ BZ9506 (II17479)	139
BY9452	K016929		143	BZ9317	II31997		139
BY9466	K020004N00		144	BZ9330	II38131F		139
BY9467	K020005N00		144	BZ9401	II14557	¹⁾ BX9400 (II37274)	139
BY9501	II17756		143	BZ9403	II14559	¹⁾ BX9400 (II37274)	139
BY9504	II18691		143	BZ9404	II16854	²⁾ BX9400 (II37274)	139
BY9505	II34017		143	BZ9404	II16854000		139
BY9506	II37145		143	BZ9404	II16854R	²⁾ BX9400 (II37274)	139
BY9512	K002163		143	BZ9405	II16855	²⁾ BZ9405 (II16855000)	139
BZ3117	I78042		130	BZ9405	II16855000		139
BZ3253	I88827		130	BZ9405	II16855R	²⁾ BX9400 (II37274)	139
BZ3324	I61423	²⁾ BZ3324 (K045254N00)	126	BZ9406	II16852		139
BZ3324	K045254N00		126	BZ9408	II15224	²⁾ BX9400 (II37274)	139
BZ3332	K045266N00		126	BZ9417	II19342	²⁾ BZ9417 (II19342000)	139
BZ3353	K045271N00		127	BZ9417	II19342000		139
BZ3438	K045255N00		127	BZ9418	II30212	²⁾ BX9400 (II37274)	139
BZ3439	K045256N00		127	BZ9424	II32006		139
BZ3441	K045260N00		127	BZ9425	II14560	²⁾ BZ9425 (II14560000)	139
BZ3442	K045261N00		127	BZ9425	II14560000		139
BZ3443	K045262N00		127	BZ9442	II32124	²⁾ BX9400 (II37274)	139
BZ3444	K045263N00		127	BZ9447	II33675	²⁾ BZ9447 (II33675000)	139
BZ3464	K045264N00		127	BZ9447	II33675000		139
BZ3473	K045267N00		127	BZ9502	II17092		139

Products in Type Number order
Produkte, nach Typnummern geordnet

Classification des Produits par Type
Prodotti ordinati per Catalogo

Type Number	Part Number	Replacement/Remplacé par Ersatz / Sostituito da	Page	Type Number	Part Number	Replacement/Remplacé par Ersatz / Sostituito da	Page
BZ9506	II17479		139	DPA5001	K028253N00		152
BZ9510	II19020	²⁾ BZ9510 (II19020000)	139	DPA6100	K026831N00		152
BZ9510	II19020000		139	DPA6101	K028254N00		152
BZ9512	II19264		139	DPA6102	K028266N00		152
BZ9513	II19265		139	DPA6103	K028300N00		152
BZ9514	II19266		139	DPA6104	K028388N00		152
BZ9529	II30079		139	DPM60AJ	K028232N09	²⁾	53
BZ9553	II18971	²⁾ BZ9553 (II18971000)	139	DPM60ND	K007426		53
BZ9553	II18971000		139	DPM61AJ	K028234N09	²⁾	53
BZ9554	II18972	²⁾ BZ9554 (II18972000)	139	DPM61BAY	K011306		53
BZ9554	II18972000		139	DPM61ND	K007429		53
BZ9566	II40321F		139	DPM64MP	K018953N01	²⁾	54
BZ9630	II19748		139	DPM64SF	K018797N01	²⁾	54
BZ9644	II31091		139	DPM65MP	K018954N01	²⁾	54
BZ9645	II31104		139	DPM66MP	K018955N01	²⁾	54
BZ9646	II32128		139	DPM67MP	K018956N01	²⁾	54
BZ9646	K041990N00		139	DPM90DD	K007443	¹⁾ DPM90DDX (K017049)	54
BZ9664	K010937		139	DPM90DDX	K017049		54
CAM1AS	K009090N00		216	DPM90DE	K010078		54
CAM1BS	K026949N00		216	DPM90DEY	K010081		54
DB1104	I22144		44	DPM90DS	K009576	¹⁾ DPM90DSX (K017050)	54
DB1114	I61241		44	DPM90DSX	K017050		54
DB1116	I61707		44	DPM92DE	K010079		54
DB1143	I83747		44	DPM93DE	K010080		54
DB1147	I97953		44	DPM93DEY	K025441N00		54
DB1150	K022185N00		44	DR3200	I54395	²⁾ 0481039240000	34
DB1151	I73591	¹⁾ DB1151 (I79644)	44	DR3200	I82495	²⁾ 0481039240000	34
DB1151	I79644		44	DR3201	0481039222000		35
DB1159	I84927		44	DR3201	I55133	²⁾ DR3201 (0481039222000)	35
DB1237	SEB01183		44	DR3203	0481039242000		35
DB1239	SEB01224		44	DR3216	I68649	¹⁾ DR3232 (0481039258000)	35
DB1240	SEB01258		44	DR3218	0481039252000		35
DB2115	I86154		63	DR3224	0481039257000		35
DB2115	K021266N00		63	DR3232	0481039258000		35
DB2116	II36219		63	DR3238	I78861	¹⁾ 0481039240000	34
DB2116	K001043		63	DR3416	I82304	¹⁾ 0481042208000	34
DB2116	K001047		63	DR3500	0481039201	²⁾ DR3500 (0481039201000)	35
DB2118	I86156		63	DR3500	0481039201000		35
DB2122	K001044		63	DR3500	I90309	²⁾ DR3500 (0481039201000)	35
DB2122	K003165		63	DR3502	0481039209000		35
DB2122	K020878N00		63	DR3502	I90311	²⁾ DR3502 (0481039209000)	35
DB2123	I72796	¹⁾ DB2123 (I86159)	63	DR3503	0481039213000		35
DB2123	I86159		63	DR3503	I82708	¹⁾ DR3503 (0481039213000)	35
DB2142	II36021		63	DR3503	I90312	¹⁾ DR3503 (0481039213000)	35
DB2142	II36022	¹⁾ DB2142 (II36021)	63	DR3510	0481039235000		35
DMV18	I7178304		44	DR3510	I82813	¹⁾ DR3510 (0481039235000)	35
DMV18	I7178305		44	DR3510	II14130	¹⁾ DR3510 (0481039235000)	35
DPA5000	K026832N00		152	DR3531	I90314	¹⁾ 0481039241000	34

Products in Type Number order
Produkte, nach Typnummern geordnet

Classification des Produits par Type
Prodotti ordinati per Catalogo

Type Number	Part Number	Replacement/Remplacé par Ersatz / Sostituito da	Page	Type Number	Part Number	Replacement/Remplacé par Ersatz / Sostituito da	Page
DR3541	I92485	¹⁾ DR3510 (0481039235000)	35	DR4372	K000638		38
DR3575	0481039268100		35	DR4373	K000639		38
DR4102	I28847	¹⁾ DR4155 (K000618)	37	DR4375	K000641		38
DR4122	I69843	²⁾ DR4155 (K000618)	37	DR4376	K000642		38
DR4123	I69844	²⁾ DR4151 (K000615)	37	DR4377	K000643		38
DR4125	I69846	²⁾ DR4150 (K000613)	37	DR4378	K000644		38
DR4126	I69847	²⁾ DR4156 (K000619)	37	DR4379	K000645		38
DR4128	I75349	²⁾ DR4153 (K000616)	37	DR4381	K000647		38
DR4135	II36146	¹⁾ DR4159 (K000622)	38	DR4383	K000649		38
DR4150	K000613		37	DR4385	K000651		38
DR4151	K000615		37	DR4395	K040216		38
DR4153	K000616		37	DR4397	K040218		38
DR4155	K000618		37	DR4502	SEB00684		38
DR4156	K000619		37	DR5117	I84406		192
DR4159	K000622		38	DR5118	I84414		192
DR4160	K040214		38	DR5122	I94158		192
DR4230	I69848	²⁾ DR4253 (K000627)	38	DR5125	I99812		192
DR4231	I69849	¹⁾ DR4263 (K014658)	38	DR5128	K040676N00		192
DR4232	I69850	²⁾ DR4256 (K000630)	38	DX60B	K013005		48, 49, 50
DR4235	I69853	²⁾ DR4260 (K000634)	38	DX61D	K006161		48
DR4236	I69854	¹⁾ DR4250 (K000624)	38	DX61E	K011883		48
DR4248	II16784	¹⁾ DR4252 (K000626)	38	DX65D	K011892		48
DR4250	K000624		38	DX65D	K011982		49
DR4252	K000626		38	DX65DH	K021896		48, 50
DR4253	K000627		38	DX80EX	K016510		48
DR4256	K000630		38	EA1152	II32611		186
DR4258	K000632		38	EA2000	II37083N50		96
DR4260	K000634		38	EDP30A	K011708		186
DR4263	K014658		38	EE1100	I55704	¹⁾ EE1100 (I94095)	31
DR4265	K028608		38	EE1100	I94095		31
DR4266	K040215		38	EE1100	SEB00224R	²⁾	31
DR4300	I27926	¹⁾ DR4373 (K000639)	38	EE1100	T55704	¹⁾ EE1100 (I94095)	31
DR4301	I27927	¹⁾ DR4378 (K000644)	38	EE1101	I16438		31
DR4304	I27929	¹⁾ DR4375 (K000641)	38	EE1106	I85893		31
DR4309	I41424	¹⁾ DR4379 (K000645)	38	EE4103	I74772		31
DR4331	I71315	¹⁾ DR4381 (K000647)	38	EE4103	T74772	²⁾ EE4103 (I74772)	31
DR4335	II36177	¹⁾ DR4377 (K000643)	38	EE4104	I84866		31
DR4340	I69856	²⁾ DR4373 (K000639)	38	EE4104	T84866	¹⁾ EE4104 (I84866)	31
DR4341	I69857	²⁾ DR4378 (K000644)	38	EE4106	II16096		31
DR4341	II30267	²⁾ DR4378 (K000644)	38	EE4107	I82646		31
DR4342	I69858	¹⁾ DR4372 (K000638)	38	EE4107	K000745		31
DR4344	I69860	²⁾ DR4375 (K000641)	38	EE4113	I88478	¹⁾ EE4103 (I74772)	31
DR4345	I69861	²⁾ DR4377 (K000643)	38	EE4115	I92054		32
DR4348	I69864	²⁾ DR4379 (K000645)	38	EE4206	I76192	¹⁾ EE4206 (II16095)	32
DR4350	I69866	¹⁾ DR4370 (K000636)	38	EE4206	II16095		32
DR4352	I75356	²⁾ DR4385 (K000651)	38	EE4207	II36087		32
DR4354	I75358	²⁾ DR4381 (K000647)	38	EK3000	EK300010000	²⁾ EK3000 (I9702110000)	121
DR4370	K000636		38	EK3000	EK30005000	²⁾ EK3000 (I970215000)	121

Products in Type Number order
Produkte, nach Typnummern geordnet

Classification des Produits par Type
Prodotti ordinati per Catalogo

Type Number	Part Number	Replacement/Remplacé par Ersatz / Sostituito da	Page	Type Number	Part Number	Replacement/Remplacé par Ersatz / Sostituito da	Page
EK3000	I97021/10000	¹⁾ EK3000 (I9702110000)	121	EK3011	II141566000		119
EK3000	I97021/12000	¹⁾ EK3000 (I9702112000)	121	EK3011	II141568000		119
EK3000	I97021/5000	¹⁾ EK3000 (I970215000)	121	EK3015	I9770410000		119
EK3000	I97021/8000	¹⁾ EK3000 (I970218000)	121	EK3015	I977045000		119
EK3000	I9702110000		121	EK3100	II36739/7	¹⁾ EK3100 (II367397)	116, 124
EK3000	I9702112000		121	EK3100	II367397		116, 124
EK3000	I9702115000		121	EK3108	II40391F2		116
EK3000	I970215000		121	EK3110	II36741/12000	¹⁾ EK3110 (II3674112000)	116
EK3000	I970218000		121	EK3110	II36741/15000	¹⁾ EK3110 (II3674115000)	116
EK3001	EK300110000	²⁾ EK3001 (II1563910000)	121	EK3110	II3674112000		116
EK3001	EK30011200		121	EK3110	II3674115000		116
EK3001	EK300112000	²⁾ EK3001 (II1563912000)	121	EK3115	II3979312000		116
EK3001	EK30012500		121	EK3122	II397873		119
EK3001	EK30013000	²⁾ EK3001 (II156393000)	121	EK3123	II397883		119
EK3001	EK30013500		121	EK3127	II39814F1		119
EK3001	EK30014000		121	EK3130	II36756/3000	¹⁾ EK3130 (II367563000)	91, 111, 122
EK3001	EK30014500		121	EK3130	II36756/5000	¹⁾ EK3130 (II367565000)	91, 111, 122
EK3001	EK30015000	²⁾ EK3001 (II156395000)	121	EK3130	II36756/6000	¹⁾ EK3130 (II367566000)	91, 111, 122
EK3001	EK30016000	²⁾ EK3001 (II156396000)	121	EK3130	II3675610000		91, 111, 122
EK3001	EK3001800		121	EK3130	II3675612000		91, 111
EK3001	EK30018000	²⁾ EK3001 (II156398000)	121	EK3130	II3675615000		91, 111, 122
EK3001	EK30018500		121	EK3130	II367562000		91, 111, 122
EK3001	II15639/10000	¹⁾ EK3001 (II1563910000)	121	EK3130	II367563000		91, 111, 122
EK3001	II15639/8000	¹⁾ EK3001 (II156398000)	121	EK3130	II367564000		91, 111, 122
EK3001	II1563910000		121	EK3130	II367565000		91, 111, 122
EK3001	II1563912000		121	EK3130	II367566000		91, 111, 122
EK3001	II156393000		121	EK3130	II367568000		91, 111, 122
EK3001	II156395000		121	EK3142	K002954		119
EK3001	II156396000		121	EK3150	K004098N00		116
EK3001	II156398000		121	EK3800	II36753		120
EK3003	II35416/3000	¹⁾ EK3003 (II354163000)	121	EL1100	K020741N50		25
EK3003	II35416/6000	¹⁾ EK3003 (II354166000)	122	EL1101	K020742N50		25
EK3003	II354163000		121	EL1500	II40116F	²⁾ EL1100 (K020741N50)	25
EK3003	II354166000		122	EL1501	II40117F	²⁾ EL1101 (K020742N50)	25
EK3010	I97255/12000	¹⁾ EK3010 (I9725512000)	119	EL2201	K007331	²⁾	25
EK3010	I97255/3000	¹⁾ EK3010 (I972553000)	119	EL2201	K033209N01	²⁾	25
EK3010	I9725512000		119	EL2203	K015444		25
EK3010	I972553000		119	EL2203	K033210N01	²⁾	25
EK3010	I972559000		119	EL9000	II41222FN00		19, 24
EK3011	EK301112000	²⁾ EK3011 (II1415612000)	119	EL9001	K011482N00		19, 24
EK3011	EK30113000	²⁾ EK3011 (II141563000)	119	EL9002	K011867N00		19, 24
EK3011	EK30114000	²⁾ EK3011 (II141564000)	119	ES1080	II30223	²⁾	82
EK3011	EK30116000	²⁾ EK3011 (II141566000)	119	ES1302	K004243	²⁾	92
EK3011	EK30118000	²⁾ EK3011 (II141568000)	119	ES1305	K004236		89, 92
EK3011	II14156/6000	¹⁾ EK3011 (II141566000)	119	ES1305	K004246		89, 92
EK3011	II1415612000		119	ES2005	II36413		92
EK3011	II141563000		119	ES2041	II39783F	²⁾ ES2053 (II397824S3M)	112
EK3011	II141564000		119	ES2041	II39783F004	²⁾ ES2053 (II397824S3M)	112

Products in Type Number order
Produkte, nach Typnummern geordnet

Classification des Produits par Type
Prodotti ordinati per Catalogo

Type Number	Part Number	Replacement/Remplacé par Ersatz / Sostituito da	Page	Type Number	Part Number	Replacement/Remplacé par Ersatz / Sostituito da	Page
ES2053	II39782	²⁾ ES2053 (II397824S3M)	112	KU1310	SEB00225	²⁾ KU1310 (II17354)	67
ES2053	II397824S3M		112	KU1310	SEB01387	¹⁾ KU1310 (II17354)	67
ES2053	II39782F004	²⁾ ES2053 (II397824S3M)	112	KU1311	I67812	¹⁾ KU1311 (II17355)	67
ES2053	II39782PG		112	KU1311	I76753	¹⁾ KU1311 (II17355)	67
ES2060	K019300V02N50	²⁾ ES2060 (K019300V03N50)	112	KU1311	I84795	¹⁾ KU1311 (II17355)	67
ES2060	K019300V03N50		112	KU1311	II17355		67
ES2060	K019302V02N50	²⁾ ES2060 (K019302V03N50)	112	KU1311	SEB00071	¹⁾ KU1311 (II17355)	67
ES2060	K019302V03N50		112	KU1311	SEB00226	¹⁾ KU1311 (II17355)	67
ES2060	K019312V04N00		112	KU1311	SEB01388	¹⁾ KU1311 (II17355)	67
ES2060	K019340V01N50	²⁾ ES2060 (K019340V02N50)	108, 112	KU1324	SEB00229	²⁾ KU1411 (K000955)	67
ES2060	K019340V02N50		108, 112	KU1400	II36178	¹⁾ KU1400 (K000952)	67
ES2060	K019342V01N50	²⁾ ES2060 (K019342V02N50)	108, 112	KU1400	K000067	²⁾ KU1400 (K000952)	67
ES2060	K019342V02N50		108, 112	KU1400	K000952		67
ES2060	K019350V02N00		108, 112	KU1401	K000174	¹⁾ KU1401 (K000953)	67
ES2060	K019352V00N00	¹⁾ ES2060 (K019352V02N00)	108, 112	KU1401	K000953		67
ES2060	K019352V02N00		108, 112	KU1410	II36180	¹⁾ KU1410 (K000954)	67
ES2070	K021940V00N00	²⁾	108, 113	KU1410	K000068	²⁾ KU1410 (K000954)	67
ES2071	K027900V00N00		108, 113	KU1410	K000954		67
EZ1020	II35434/3000	¹⁾ EZ1020 (II354343000)	94	KU1411	II36181	¹⁾ KU1411 (K000955)	67
EZ1020	II354343000		94	KU1411	K000173	²⁾ KU1411 (K000955)	67
EZ1022	II36381		94	KU1411	K000955		67
EZ1031	II39809F		124	KU1412	K000079	²⁾ KU1412 (K000956)	67
EZ1031	K001556	¹⁾ EZ1031 (II39809F)	124	KU1412	K000956		67
EZ1032	II39812F		124	KU4124	I58101	¹⁾ KU4124 (K004231)	67
EZ1033	II39813F	¹⁾ EZ1033 (Z00546)	124	KU4124	I71420	²⁾ KU4124 (K004231)	67
EZ1033	Z005464		124	KU4124	K004229		67
EZ1034	II39808F		124	KU4124	K004231		67
EZ1035	K009166	²⁾ EZ1035 (K009166V02N00)	109	KU4124	K013662		67
EZ1035	K009166V02N00		109	KU4124	K018111N00		67
EZ1037	K010837N00		124	KU4124	SEB00077	¹⁾ KU4124 (K004231)	67
EZ2085	K036198V00N00		113	KU4124	SEB00227	¹⁾ KU4124 (K004231)	67
HB1143	I61720	¹⁾ HB1143 (I82171N00)	54	KU4124	SEB00436	¹⁾ KU4124 (K004231)	67
HB1143	I82171	²⁾ HB1143 (I82171N00)	54	KU4124	SEB00681	¹⁾ KU4124 (K004231)	67
HB1143	I82171N00		54	KU4124	SEB01389	¹⁾ KU4124 (K004231)	67
HB1242	I85193		54	KU4128	I59068	¹⁾ KU4128 (K004230)	67
HB1258	I92030		54	KU4128	I71421	²⁾ KU4128 (K004230)	67
HB1267	I98746		54	KU4128	I86233	¹⁾ KU4128 (K004230)	67
HB1350	I82177		54	KU4128	K004152		67
KU1303	I59070		66	KU4128	K004230		67
KU1304	I59258		66	KU4128	K013661		67
KU1304	II33262		66	KU4128	K013663	²⁾ KU4128 (K013661)	67
KU1305	I59259	¹⁾ KU1305 (II33263)	67	KU4128	K018110N00		67
KU1305	II33263		67	KU4128	SEB00080	¹⁾ KU4128 (K004230)	67
KU1310	I67813	¹⁾ KU1310 (II17354)	67	KU4128	SEB00228	¹⁾ KU4128 (K004230)	67
KU1310	I76752	¹⁾ KU1310 (II17354)	67	KU4128	SEB00437	¹⁾ KU4128 (K004230)	67
KU1310	I84794	¹⁾ KU1310 (II17354)	67	KU4128	SEB00682	¹⁾ KU4128 (K004230)	67
KU1310	II17354		67	KU4128	SEB01390	¹⁾ KU4128 (K004230)	67
KU1310	SEB00066	¹⁾ KU1310 (II17354)	67	KU4128	SEB01446	¹⁾ KU4128 (K004230)	67

Products in Type Number order
Produkte, nach Typnummern geordnet

Classification des Produits par Type
Prodotti ordinati per Catalogo

Type Number	Part Number	Replacement/Remplacé par Ersatz / Sostituito da	Page	Type Number	Part Number	Replacement/Remplacé par Ersatz / Sostituito da	Page
LA2103	I99660		29	LA8015	II19369	²⁾ LA8015 (II19369N00)	19
LA4115	I82291		26	LA8015	II19369N00		19
LA4116	I90375		26	LA8016	II37927	²⁾ LA8016 (II37927N00)	19
LA4117	I82293		26	LA8016	II37927N00		19
LA4127	I84828	¹⁾ LA4127 (I90186)	26	LA8027	II30455		19
LA4127	I90186		26	LA8028	II30458		19
LA4129	I98916		26	LA8032	II31877		19
LA4135	I94650		26	LA8040	II34976	²⁾ LA8040 (II34976N00)	19
LA6200	I85133	¹⁾ LA8228 (II30185)	21	LA8040	II34976N00		19
LA6205	I86647	¹⁾ LA8229 (II30443N00)	21	LA8041	II37928	²⁾ LA8041 (II37928N00)	19
LA6209	I87101	¹⁾ LA8233 (II30447)	21	LA8041	II37928N00		19
LA6210	I87501		19	LA8041	II37928R	²⁾ LA8041 (II37928N00)	19
LA6212	I88182	¹⁾ LA6221 (I92013)	19	LA8044	II35526		19
LA6215	I89326	²⁾ LA8242 (II30650N00)	21	LA8049	II37921N00	²⁾ LA8075 (K020337N00)	20
LA6217	I89776	¹⁾ LA8245 (II30810)	21	LA8050	II37924		20
LA6221	I92013		19	LA8054	K018395		20
LA6222	I92081	²⁾ LA8254 (II31475)	21	LA8057	II38786F	²⁾	20
LA6248	I98919	¹⁾ LA8206 (II19375)	21	LA8058	II38787F	²⁾ LA8074 (K016602N00)	20
LA6250	I89256	¹⁾ LA8250 (II31112)	21	LA8058	II38787FN00	²⁾ LA8074 (K016602N00)	20
LA6252	I89258	¹⁾ LA8225 (II30179)	21	LA8060	II38798F		20
LA6252	K000065		19	LA8061	II39054F	²⁾ LA8061 (II39054FN00)	20
LA6253	I89259	¹⁾ LA8228 (II30185)	21	LA8061	II39054FN00		20
LA6268	II19330	¹⁾ LA8205 (II19216)	21	LA8061	II39054FR	²⁾ LA8061 (II39054FN00)	20
LA6273	II39748F	²⁾ LA8546 (K018578)	22	LA8062	II40133F		20
LA6277	II39867F		19	LA8063	K000754	²⁾ LA8063 (K000754N00)	20
LA6710	II36935	²⁾ LA6710 (II36935000)	19	LA8063	K000754N00		20
LA6710	II36935000		19	LA8064	K000755	²⁾ LA8064 (K000755N00)	20
LA6711	II36936	²⁾ LA6711 (II36936000)	19	LA8064	K000755N00		20
LA6711	II36936000		19	LA8064	K000755R	²⁾ LA8064 (K000755N00)	20
LA6734	II36933	²⁾ LA8702 (K023357)	22	LA8065	K001056	²⁾ LA8065 (K001056N00)	20
LA6735	I98189	²⁾ LA8704 (K025606)	22	LA8065	K001056N00		20
LA8001	II19332	²⁾ LA8001 (II19332N00)	19	LA8065	K001056R	²⁾ LA8065 (K001056N00)	20
LA8001	II19332N00		19	LA8066	K001197	²⁾ LA8004 (II19335N00)	19
LA8002	II19333	²⁾ LA8002 (II19333N00)	19	LA8068	K002135		20
LA8002	II19333N00		19	LA8069	K004692		20
LA8003	II19334	²⁾ LA8003 (II19334N00)	19	LA8073	K016601N00		20
LA8003	II19334N00		19	LA8074	K016602	²⁾ LA8074 (K016602N00)	20
LA8004	II19335	²⁾ LA8004 (II19335N00)	19	LA8074	K016602N00		20
LA8004	II19335N00		19	LA8075	K020337	²⁾ LA8075 (K020337N00)	20
LA8006	II19337	²⁾ LA8006 (II19337N00)	19	LA8075	K020337N00		20
LA8006	II19337N00		19	LA8076	K020338	²⁾ LA8076 (K020338N00)	20
LA8007	II19338	²⁾	19	LA8076	K020338N00		20
LA8008	II19362	²⁾ LA8008 (II19362N00)	19	LA8104	II38302F	²⁾ LA8104 (II38302FN00)	20, 24
LA8008	II19362N00		19	LA8104	II38302FN00		20, 24
LA8008	K000479		19	LA8105	II38303F	²⁾ LA8105 (II38303FN00)	20, 24
LA8011	II37926	²⁾ LA8011 (II37926N00)	19	LA8105	II38303FN00		20, 24
LA8011	II37926N00		19	LA8106	II38304F	²⁾ LA8106 (II38304FN00)	20, 24
LA8013	II19367	²⁾ LA8004 (II19335N00)	19	LA8106	II38304FN00		20, 24

Products in Type Number order
Produkte, nach Typnummern geordnet

Classification des Produits par Type
Prodotti ordinati per Catalogo

Type Number	Part Number	Replacement/Remplacé par Ersatz / Sostituito da	Page	Type Number	Part Number	Replacement/Remplacé par Ersatz / Sostituito da	Page
LA8107	II38305F	²⁾ LA8107 (II38305FN00)	20, 24	LA8205	II19216		21
LA8107	II38305FN00		20, 24	LA8206	II19375		21
LA8116	II38620F	²⁾ LA8116 (II38620FN00)	20, 23	LA8207	II19204		21
LA8116	II38620F000	²⁾ LA8116 (II38620FN00)	20, 23	LA8208	II19205		21
LA8116	II38620FN00		20, 23	LA8209	II19206		21
LA8117	II38672F	²⁾ LA8130 (K000390N00)	20, 23	LA8210	II19207		21
LA8118	II38785F	²⁾ LA8131 (K000391N00)	20, 23	LA8211	II19208		21
LA8118	II38785F000	¹⁾ LA8131 (K000391N00)	20, 23	LA8212	II19209		21
LA8119	II38800F	²⁾ LA8132 (K000392N00)	20, 23	LA8219	II19483	²⁾ LA8219 (II19483N00)	21
LA8124	II40554F	²⁾ LA8124 (II40554FN00)	20, 23, 24	LA8219	II19483N00		21
LA8124	II40554FN00		20, 23, 24	LA8220	II19484	²⁾ LA8220 (II19484N00)	21
LA8125	II40555F	²⁾ LA8125 (II40555FN00)	20, 23, 24	LA8220	II19484N00		21
LA8125	II40555FN00		20, 23, 24	LA8221	II19485	²⁾ LA8221 (II19485N00)	21
LA8126	II40556FN00		24	LA8221	II19485N00		21
LA8127	II40557F	²⁾ LA8127 (II40557FN00)	20, 24	LA8222	II19486	²⁾ LA8222 (II19486N00)	21
LA8127	II40557FN00		20, 24	LA8222	II19486N00		21
LA8128	II40558F	²⁾ LA8128 (II40558FN00)	20, 24	LA8223	II30178		21
LA8128	II40558FN00		20, 24	LA8224	II30182		21
LA8129	II40559F	²⁾ LA8129 (II40559FN00)	20, 24	LA8225	II30179		21
LA8129	II40559FN00		20, 24	LA8226	II30180		21
LA8130	K000390	²⁾ LA8130 (K000390N00)	20, 23	LA8227	II30181		21
LA8130	K000390N00		20, 23	LA8228	II30185		21
LA8131	K000391	²⁾ LA8131 (K000391N00)	20, 23	LA8229	II30443	²⁾ LA8229 (II30443N00)	21
LA8131	K000391N00		20, 23	LA8229	II30443N00		21
LA8132	K000392	²⁾ LA8132 (K000392N00)	20, 23	LA8230	II30444		21
LA8132	K000392N00		20, 23	LA8233	II30447		21
LA8136	K002148N00		20, 24	LA8233	K004564		21
LA8137	K011984N00		20, 24	LA8234	II30448		21
LA8138	K011985N00		20, 24	LA8235	II30449	²⁾ LA8230 (II30444)	21
LA8140	K013767	²⁾	24	LA8235	II30499	¹⁾ LA8230 (II30444)	21
LA8140	K013767N00		20	LA8239	II30657		21
LA8141	K013768	²⁾	24	LA8242	II30650	²⁾ LA8242 (II30650N00)	21
LA8141	K013768N00		20	LA8242	II30650N00		21
LA8142	K013769	²⁾	24	LA8245	II30810		21
LA8142	K013769N00		20	LA8250	II31112		21
LA8143	K013770	²⁾	24	LA8253	II31119		21
LA8143	K013770N00		20	LA8254	II31475		21
LA8144	K014319N00		20, 24	LA8259	II31481		21
LA8145	K014986	²⁾	24	LA8269	II35522		21
LA8145	K014986N00		20	LA8270	II35523		21
LA8146	K014981	²⁾	24	LA8271	II39751F00		21
LA8146	K014981N00		20	LA8271	II39751F000	¹⁾ LA8271 (II39751F00)	21
LA8147	K014980	²⁾	24	LA8272	II36257	²⁾ LA8272 (II36257N00)	22
LA8147	K014980N00		20	LA8272	II36257N00		22
LA8148	K015071	²⁾ LA8145 (K014986N00)	20	LA8286	II39752F00		22
LA8149	K015072	²⁾ LA8146 (K014981N00)	20	LA8286	II39752F000	¹⁾ LA8286 (II39752F00)	22
LA8156	K033356		20, 24	LA8289	K000336		22
LA8157	K033952	²⁾	21, 24	LA8298	K002174		22

Products in Type Number order
Produkte, nach Typnummern geordnet

Classification des Produits par Type
Prodotti ordinati per Catalogo

Type Number	Part Number	Replacement/Remplacé par Ersatz / Sostituito da	Page	Type Number	Part Number	Replacement/Remplacé par Ersatz / Sostituito da	Page
LA8509	K007770	²⁾ LA8509 (K007770N00)	22	LK3517	II39521F		12
LA8509	K007770N00		22	LK3826	II34069		12
LA8510	K007771	²⁾ LA8510 (K007771N00)	22	LK3833	SEB01586	²⁾ LK3833 (SEB015)	12
LA8510	K007771N00		22	LK3833	SEB01586000		12
LA8517	K013479		22	LK3834	SEB01597	²⁾ LK3834 (SEB015)	12
LA8542	K017710	²⁾ LA8211 (II19208)	21	LK3834	SEB01597000		12
LA8543	K017711	²⁾	22	LK3839	K000853000	¹⁾ LK3875 (K008457000)	12
LA8544	K017294		22	LK3839	SEB01604	¹⁾ LK3875 (K008457000)	12
LA8545	K022369		22	LK3840	K002141	²⁾ LK3840 (K002141000)	12
LA8546	K018578		22	LK3840	K002141000		12
LA8547	K023400	²⁾	22	LK3840	SEB01605	²⁾ LK3840 (K002141000)	12
LA8555	K028030	²⁾	22	LK3840	SEB01819000	¹⁾ LK3840 (K002141000)	12
LA8702	K023357		22	LK3841	K004640	²⁾ LK3841 (K004640X00)	12
LA8704	K025606		22	LK3841	K004640X00		12
LA9000	II17366	¹⁾ LA9034 (K024634N00)	22, 24	LK3841	SEB01606	¹⁾ LK3841 (K004640X00)	12
LA9001	II17369	¹⁾ LA9034 (K024634N00)	22, 24	LK3846	K000861	²⁾ LK3846 (K000861000)	12
LA9004	II36007		22, 23	LK3846	K000861000		12
LA9010	II38308F	²⁾ LA9010 (II38308FN00)	22, 23	LK3846	K017274		12
LA9010	II38308FN00		22, 23	LK3846	SEB01817	²⁾ LK3846 (K000861000)	12
LA9011	II38309F	²⁾ LA9010 (II38308FN00)	22, 23	LK3848	K019284		12
LA9011	II38309FN00		22	LK3848	SEB01799	²⁾ LK3848 (K019284)	12
LA9013	K001076	²⁾ LA9013 (K024486)	22	LK3848	SEB01799000	²⁾ LK3848 (K019284)	12
LA9013	K010274	²⁾ LA9013 (K024486)	22	LK3848	SEB01799X00	²⁾ LK3848 (K019284)	12
LA9013	K024486		22	LK3850	SEB01768	²⁾ LK3850 (SEB017)	12
LA9017	K002739	²⁾ LA9035 (K024635N00)	22, 24	LK3850	SEB01768000		12
LA9018	K002740	²⁾ LA9035 (K024635N00)	22, 24	LK3866	K001282	¹⁾ LK3866 (K018385)	12
LA9018	K002740N00		22	LK3866	K018385		12
LA9024	K010514		22, 23	LK3867	K001728	²⁾ LK3867 (K001728000)	12
LA9034	K024634	²⁾ LA9034 (K024634N00)	22, 24	LK3867	K001728000		12
LA9034	K024634N00		22, 24	LK3869	K002404	¹⁾ LK3869 (K016932)	12
LA9035	K024635	²⁾ LA9035 (K024635N00)	22, 24	LK3869	K016932		12
LA9035	K024635N00		22, 24	LK3869	K016932000	²⁾ LK3869 (K016932)	12
LK1309	I84038	¹⁾ LK1314 (I87544)	12	LK3872	K004852	²⁾ LK3872 (K004852000)	12
LK1311	I86164		12	LK3872	K004852000		12
LK1314	I87544		12	LK3875	K008457	²⁾ LK3875 (K008457000)	12
LK1534	I92972		12	LK3875	K008457000		12
LK1545	I98498		12	LK3921	I90521	²⁾ LP8701 (K015518)	13
LK1554	SEB01149	¹⁾ LK1567 (SEB016)	12	LK3927	I94064		12
LK1560	II17393		12	LK3927	II31951	²⁾ LK3927 (I94064)	12
LK1565	II38775F		12	LK3935	II14781	¹⁾ LK3935 (II19494)	12
LK1566	II39151F		12	LK3935	II19494		12
LK1567	SEB01686	²⁾ LK1567 (SEB016)	12	LK3947	K000740	²⁾ LK3947 (K040432N00)	12
LK1567	SEB01686000		12	LK3947	K040432N00		12
LK1573	K014774		12	LK3955	II19495	²⁾ LK3935 (II19494)	12
LK1802	I80864		12	LK3959	K000741		12
LK1813	II14570	¹⁾ LK1813 (II18355)	12	LK3965	II33163		13
LK1813	II18355		12	LK3966	II32223		13
LK3515	II32224		12	LK3980	II36925		13

Products in Type Number order
Produkte, nach Typnummern geordnet

Classification des Produits par Type
Prodotti ordinati per Catalogo

Type Number	Part Number	Replacement/Remplacé par Ersatz / Sostituito da	Page	Type Number	Part Number	Replacement/Remplacé par Ersatz / Sostituito da	Page
LK3980	II36925000	²⁾ LK3980 (II36925)	13	LK4954	K010866	¹⁾ LK4954 (K017528)	15
LK3985	K000742	²⁾ LK3959 (K000741)	12	LK4954	K017528		15
LK3994	SEB01842	²⁾ LK3994 (SEB018)	13	LK4954	K017528000	²⁾ LK4954 (K017528)	15
LK3994	SEB01842000		13	LK4958	K013739		15
LK4918	II39077F	¹⁾ LK4918 (K001267000)	15	LK4959	K014371		15
LK4918	K000230	¹⁾ LK4918 (K001267000)	15	LK4959	K014371000	²⁾ LK4959 (K014371)	15
LK4918	K001267	²⁾ LK4918 (K001267000)	15	LK4960	K015108		15
LK4918	K001267000		15	LK4960	K015108000	²⁾ LK4960 (K015108)	15
LK4919	K000231	¹⁾ LK4919 (K002029000)	15	LK4961	K018625000		15
LK4919	K002029	²⁾ LK4919 (K002029000)	15	LK4962	K019158	¹⁾ LK4962 (K037049N00)	15
LK4919	K002029000		15	LK4962	K037049N00		15
LK4920	K000232	¹⁾ LK4920 (K002032000)	15	LK4963	K033412N00		15
LK4920	K002032	²⁾ LK4920 (K002032000)	15	LK4968	K026846N01	²⁾	15
LK4920	K002032000		15	LK8901	K015410		13
LK4921	K000233	²⁾ LK4921 (K001268000)	15	LK8901	K015410000	²⁾ LK8901 (K015410)	13
LK4921	K001268	²⁾ LK4921 (K001268000)	15	LK8905	K040960N00		13
LK4921	K001268000		15	LP1596	SEB00416	¹⁾ LK1567 (SEB016)	12
LK4927	II39523F		15	LP2983	I183843	¹⁾ LP2983 (I83843)	15
LK4928	K015965		15	LP2983	I83843		15
LK4930	K009403	²⁾ LK4930 (K009403000)	15	LP3832	I77535	¹⁾ LP3860 (SEB011)	13
LK4930	K009403000		15	LP3832	SEB00348	¹⁾ LP3860 (SEB011)	13
LK4932	K000513		15	LP3852	SEB00650	¹⁾ LP3861 (SEB011)	13
LK4934	K001671	¹⁾ LK4960 (K015108)	15	LP3860	SEB01151		13
LK4935	K001207000	¹⁾ LA8068 (K002135)	20	LP3861	SEB01152	²⁾ LP3861 (SEB011)	13
LK4935	K002123	²⁾ LK4935 (K002123000)	15	LP3861	SEB01152000		13
LK4935	K002123000		15	LP3861	SEB01152R	²⁾ LP3861 (SEB011)	13
LK4936	K001126	²⁾ LK4936 (K001126000)	15	LP3955	K003084000	¹⁾	13
LK4936	K001126000		15	LP3955	K003084X00	²⁾ LP3955 (K003084000)	13
LK4936	K022263N00		15	LP3970	K004641	²⁾ LP3970 (K004641000)	13
LK4937	K001127	²⁾ LK4937 (K001127000)	15	LP3970	K004641000		13
LK4937	K001127000		15	LP3970	SEB01751	¹⁾ LP3970 (K004641000)	13
LK4939	K001998		15	LP3974	K017428		13
LK4941	K014896	¹⁾ LK4941 (K016615000)	15	LP3974	K017428000	²⁾ LP3974 (K017428)	13
LK4941	K016615	²⁾ LK4941 (K016615000)	15	LP3974	SEB01791		13
LK4941	K016615000		15	LP3977	K000855	¹⁾ LP3977 (K014799000)	13
LK4944	K002183	¹⁾ LK4944 (K017527000)	15	LP3977	K000855000	¹⁾ LP3977 (K014799000)	13
LK4944	K017527000		15	LP3977	K014799	²⁾ LP3977 (K014799000)	13
LK4945	K014416	²⁾ LK4968 (K026846N01)	15	LP3977	K014799000		13
LK4945	K024357	¹⁾ LK4968 (K026846N01)	15	LP3977	SEB01795000	²⁾ LP3977 (K014799000)	13
LK4945	K024358	¹⁾ LK4968 (K026846N01)	15	LP3977	SEB01795X00	²⁾ LP3977 (K014799000)	13
LK4947	K015309N04	²⁾	15	LP3980	K004489	²⁾ LP3997 (K015948)	13
LK4949	K009580	²⁾ LK4949 (K009580000)	15	LP3986	K005977	²⁾	13
LK4949	K009580000		15	LP3997	K015948		13
LK4951	K009581	²⁾ LK4951 (K009581000)	15	LP3997	K015948000	²⁾ LP3997 (K015948)	13
LK4951	K009581000		15	LP3998	K011192	²⁾ LK8905 (K040960N00)	13
LK4951	K024410N00		15	LP4813	I90499	²⁾ LP4813 (I90499000)	16
LK4952	K002120000		15	LP4813	I90499000		16
LK4952	K022264N00		15	LP4813	I90499V	²⁾ LP4813 (I90499000)	16

Products in Type Number order
Produkte, nach Typnummern geordnet

Classification des Produits par Type
Prodotti ordinati per Catalogo

Type Number	Part Number	Replacement/Remplacé par Ersatz / Sostituito da	Page	Type Number	Part Number	Replacement/Remplacé par Ersatz / Sostituito da	Page
LP4814	I97492	²⁾ LP4814 (I97492000)	16	LP4944	SEB01159000		16
LP4814	I97492000		16	LP4957	II17395	¹⁾ LP4957 (K002975000)	16
LP4815	I97493	²⁾ LP4815 (I97493000)	16	LP4957	K002045	¹⁾ LP4957 (K002975000)	16
LP4815	I97493000		16	LP4957	K002975	²⁾ LP4957 (K002975000)	16
LP4818	SEB00820	²⁾ LP4818 (SEB008)	16	LP4957	K002975000		16
LP4818	SEB00820000		16	LP4960	K000237	²⁾ LP4960 (K000237000)	16
LP4823	II15697	¹⁾ LP4823 (SEB017)	16	LP4960	K000237000		16
LP4823	II15697M1	¹⁾ LP4823 (SEB017)	16	LP4961	II30900		16
LP4823	II34840	¹⁾ LP4823 (SEB017)	16	LP4964	II32687	¹⁾ LP4964 (K002046000)	16
LP4823	SEB01782	²⁾ LP4823 (SEB017)	16	LP4964	K002046	²⁾ LP4964 (K002046000)	16
LP4823	SEB01782000		16	LP4964	K002046000		16
LP4823	SEB01782X00	²⁾ LP4823 (SEB017)	16	LP4965	II32688	¹⁾ LK4941 (K016615000)	15
LP4825	II15993	²⁾ LP4825 (II15993000)	16	LP4967	II33164	²⁾ LP4967 (II33164000)	16
LP4825	II15993000		16	LP4967	II33164000		16
LP4827	SEB01452	¹⁾ LP4845 (SEB014)	16	LP4967	II33164V	²⁾ LP4967 (II33164000)	16
LP4830	II18599	¹⁾ LP4830 (SEB017)	16	LP4969	II34404	²⁾ LP4969 (II34404N00)	16
LP4830	II34841	¹⁾ LP4830 (SEB017)	16	LP4969	II34404N00		16
LP4830	SEB01781		16	LP4974	II37214	¹⁾ LP4974 (K000236000)	16
LP4830	SEB01781X00	²⁾ LP4830 (SEB017)	16	LP4974	K000236	²⁾ LP4974 (K000236000)	16
LP4832	SEB01245		16	LP4974	K000236000		16
LP4832	SEB01245000	²⁾ LP4832 (SEB012)	16	LP4983	SEB01784	²⁾ LP4983 (SEB017)	16
LP4833	SEB01485	¹⁾ LP4833 (SEB014)	16	LP4983	SEB01784000		16
LP4833	SEB01485X00		16	LP4983	SEB01784X00	²⁾ LP4983 (SEB017)	16
LP4840	SEB01392	²⁾ LP4840 (SEB013)	16	LP4984	II37752	¹⁾ LP4984 (SEB017)	16
LP4840	SEB01392X00		16	LP4984	SEB01783	²⁾ LP4984 (SEB017)	16
LP4843	SEB01430		16	LP4984	SEB01783000		16
LP4845	SEB01455	²⁾ LP4845 (SEB014)	16	LP4985	II37760	¹⁾ LP4985 (K000229000)	16
LP4845	SEB01455000		16	LP4985	K000229	²⁾ LP4985 (K000229000)	16
LP4850	II35564	²⁾ LP4850 (II35564000)	16	LP4985	K000229000		16
LP4850	II35564000		16	LP4992	K000235	¹⁾ LP4992 (K002031000)	16
LP4851	SEB01545	²⁾ LP4851 (SEB015)	16	LP4992	K002031	²⁾ LP4992 (K002031000)	16
LP4851	SEB01545000		16	LP4992	K002031000		16
LP4852	SEB01588		16	LP4993	II38779F	¹⁾ LK4918 (K001267000)	15
LP4855	SEB01747		16	LP4999	SEB01676		16
LP4857	K000821000	²⁾ LP4857 (K022249N00)	16	LP8701	K015518		13
LP4857	K022249N00		16	LS3907	K035435N04	²⁾	13
LP4864	K006612	²⁾ LP4864 (K033392N00)	16	MB1200	I27644	¹⁾ MB1200 (I72775)	48
LP4864	K033392N00		16	MB1200	I72775		48
LP4865	K006613	²⁾ LP4865 (K033404N00)	16	MB1226	II16361		48
LP4865	K033404N00		16	MB4436	I82111		48
LP4871	K035001N00		16	MB4512	I55727		48
LP4930	II15698	¹⁾ LP4974 (K000236000)	16	MB4611	SEB01098		48
LP4934	II15992000	²⁾ LP4934 (II30895)	16	MB4630	I74907		48
LP4934	II30895		16	MB4630	I76624	¹⁾ MB4630 (I74907)	48
LP4939	SEB01154000	¹⁾	16	MB4644	I84433	¹⁾ 0481064103000	47
LP4941	SEB01156000		16	MB4690	I99719	¹⁾ MB4849 (II36174000)	48
LP4943	SEB01158	²⁾ LP4943 (SEB011)	16	MB4694	II14119		48
LP4943	SEB01158000		16	MB4694	II36045		48

Products in Type Number order
Produkte, nach Typnummern geordnet

Classification des Produits par Type
Prodotti ordinati per Catalogo

Type Number	Part Number	Replacement/Remplacé par Ersatz / Sostituito da	Page	Type Number	Part Number	Replacement/Remplacé par Ersatz / Sostituito da	Page
MB4747	I89742		48	PU3AXYD	K007466		49
MB4763	II36060		48	PU3AXYS	K007468		49
MB4813	II19088	¹⁾ MB4813 (II36364)	48	PU3MYD	K021920N00		49
MB4813	II36364		48	PU3MYS	K021919N00		49
MB4815	II19090	²⁾ MB4815 (II36302)	48	PU4AX	K009935		49
MB4815	II36302		48	PU4AXYD	K012908		49
MB4820	II30848	²⁾ MB4820 (II36300)	48	PU4AXYS	K012907		49
MB4820	II36300		48	PU4BMYD	K024648N00		49
MB4821	II30849	¹⁾ MB4821 (II36299)	48	PU4BMYS	K024645N00		49
MB4821	II36299		48	PU4BXVD	K013147		49
MB4833	II36293		48	PU4BXYS	K013146		49
MB4836	II36296		48	PU4MYD	K024500N00		49
MB4847	II36120	¹⁾ MB4849 (II36174000)	48	PU4MYS	K022470N00		49
MB4849	II36174	²⁾ MB4849 (II36174000)	48	PU6AX	K009363		49
MB4849	II36174000		48	PU7AX	K010558		50
MB4850	K000014		48	PU7BX	K015137		50
MB4852	K014516		48	RE1110	I76792		61
MB9000	II37181	²⁾ MB9000 (II37181N50)	99	RE1115	I76204	²⁾ AC574AA (K008490)	61
MB9000	II37181N50		99	RE1115	I76627	¹⁾ AC574AA (K008490)	61
MC18	1194186		213	RE1141	II16468		61
MC19	758188.01SP		213	RE2113	I74908		62
MC1A	K015310		50, 213	RE2117	I82697000	²⁾	62
MC1D	K013984		50, 213	RE2118	I92200		62
MC20	1189421SP		213	RE2131	II36017		62
MC2AKR	K029301N00		213	RE2131	II36018	¹⁾ RE2131 (II36017)	62
MC2AR	K029411N00		213	RE2221	I61840	¹⁾ RE2221 (I63354)	61
MC2B	K022011N00		213	RE2221	I63354		61
MC3A	K023831		50	RE2223	I76938	¹⁾ RE2221 (I63354)	61
MC3A	K023831N00		213	RE2230	II34747	¹⁾ AC596A	64
PU12CXD	K040266N00		50	RE3310	SEB01100	¹⁾ RE3312 (II39050F000)	61
PU12CXS	K040265N00		50	RE3311	II38821F		61
PU12DD	K015827		50	RE3312	II39050F	²⁾ RE3312 (II39050F000)	61
PU12DS	K015826		50	RE3312	II39050F000		61
PU12DXD	K040268N00		50	RP2B	K016654		61
PU12DXS	K040267N00		50	SB5002	II36683	¹⁾	164
PU16CD	K015507		50	SB5002	II36683AT	¹⁾	164
PU16CS	K015506		50	SB5002	II36687	¹⁾	164
PU16CXD	K031478N00		50	SB5003	II36681	¹⁾	164
PU16CXS	K031475N00		50	SB5003	II36685	¹⁾	164
PU16DD	K015509		50	SB5003	II37803	¹⁾	165
PU16DS	K015508		50	SB5003	II37805	¹⁾	165
PU16DXD	K015511		50	SB5006	II38632F	¹⁾ SB5016 (K002520)	172
PU16DXS	K015510		50	SB5006	K002519	¹⁾	172
PU17DXD	K016807		50	SB5012	II36684	¹⁾	164
PU17DXS	K016806		50	SB5012	II36684AT	¹⁾	164
PU18DS	K024480N00		50	SB5012	II36688	¹⁾	164
PU1AXYD	K007464		49	SB5013	II36682	¹⁾	164
PU1AXYS	K007465		49	SB5013	II36686	¹⁾	164

Products in Type Number order
Produkte, nach Typnummern geordnet

Classification des Produits par Type
Prodotti ordinati per Catalogo

Type Number	Part Number	Replacement/Remplacé par Ersatz / Sostituito da	Page	Type Number	Part Number	Replacement/Remplacé par Ersatz / Sostituito da	Page
SB5013	II37804	¹⁾	165	SB6527	II37686	¹⁾	165
SB5013	II37806	¹⁾	165	SB6527	II37686M1	¹⁾ SB6527 (II37686)	165
SB5016	II38633F	¹⁾ SB5006 (K002519)	172	SB6527	K000095	¹⁾	167
SB5016	K002520	¹⁾	172	SB6527	Z0011451	¹⁾	181
SB6400R	K002874	¹⁾	172	SB6527	Z0011451M1	¹⁾ SB6527 (Z0011451)	180
SB6403R	K002915	¹⁾	172	SB6527	Z0016511	¹⁾	181
SB6404R	K002878	¹⁾	172	SB6527	Z0016511M1	¹⁾ SB6527 (Z0016511)	181
SB6410R	K002875	¹⁾	172	SB6528	II37690	¹⁾	165
SB6413R	K002916	¹⁾	172	SB6528	II39048F	¹⁾	167
SB6414R	K002879	¹⁾	172	SB6528	K000005	¹⁾	167
SB6500	II19453	¹⁾	162	SB6528	Z0011561	¹⁾	181
SB6502	II30692	¹⁾	162	SB6529	II37810	¹⁾	166
SB6503	II31017	¹⁾	162	SB6530	II34162	¹⁾	163
SB6503	II31017M1	¹⁾	162	SB6530	II34162M1	¹⁾ SB6530 (II34162)	162
SB6503	II37223	¹⁾	165	SB6530	II39047F	¹⁾	167
SB6506	II32804	¹⁾ SB6506 (II36703)	164	SB6530	II39047FM1	¹⁾ SB6530 (II39047F)	166
SB6506	II36699	¹⁾	164	SB6530	K002143	¹⁾	171
SB6506	II36703	¹⁾	164	SB6531	K000323	¹⁾	168
SB6507	II32806	¹⁾	162	SB6535	II37026	¹⁾	164
SB6507	II36701	¹⁾	164	SB6535	II37802	¹⁾	165
SB6507	II36705	¹⁾	164	SB6537	II37253	¹⁾ Z0016512AT	181
SB6507	II37797	¹⁾	165	SB6537	II37687	¹⁾	165
SB6507	II37799	¹⁾	165	SB6537	II37687M1	¹⁾ SB6537 (II37687)	165
SB6508	II33428	¹⁾	162	SB6537	K000096	¹⁾	167
SB6508	II37225		165	SB6537	Z0011452	¹⁾	181
SB6512	II30693	¹⁾	162	SB6537	Z0011452M1	¹⁾ SB6537 (Z0011452)	180
SB6513	II31018	¹⁾	162	SB6537	Z0016512	¹⁾	181
SB6513	II31018M1	¹⁾	162	SB6537	Z0016512M1	¹⁾ SB6537 (Z0016512)	181
SB6513	II37224	¹⁾	165	SB6538	II37691	¹⁾	165
SB6516	II32805	¹⁾ SB6516 (II36704)	164	SB6538	II39049F	¹⁾	167
SB6516	II36700	¹⁾	164	SB6538	K000006	¹⁾	167
SB6516	II36704	¹⁾	164	SB6538	Z0011562	¹⁾	181
SB6517	II32807	¹⁾	162	SB6539	II37811	¹⁾	166
SB6517	II36702	¹⁾	164	SB6540	II39036F		166
SB6517	II36706	¹⁾	164	SB6540	II39038F	¹⁾	166
SB6517	II37798	¹⁾	165	SB6543	Z0011891	¹⁾	181
SB6517	II37800	¹⁾	165	SB6545	II39068F		167
SB6518	II33429	¹⁾	162	SB6546	II39251F		167
SB6518	II37226		165	SB6547	II39258F	²⁾	167
SB6520	II34161	¹⁾	163	SB6547	II39258FM1	¹⁾ SB6547 (II39258F)	166
SB6520	II34161M1	¹⁾ SB6520 (II34161)	162	SB6547	II39258FM2	¹⁾ SB6547 (II39258F)	166
SB6520	II39046F	¹⁾	167	SB6548	II39266F	¹⁾	167
SB6520	II39046FM1	¹⁾ SB6520 (II39046F)	166	SB6548	II39266FM1	¹⁾ SB6548 (II39266F)	167
SB6520	K002142	¹⁾	171	SB6548	K000105	¹⁾	167
SB6521	K000322	¹⁾	168	SB6548	K000115	¹⁾	167
SB6525	II37025	¹⁾	164	SB6548	Z0011541	¹⁾	181
SB6525	II37801	¹⁾	165	SB6548	Z0017671	¹⁾	181
SB6527	II37252	¹⁾ Z0016511AT	181	SB6549	II39274F	¹⁾	167

Products in Type Number order
Produkte, nach Typnummern geordnet

Classification des Produits par Type
Prodotti ordinati per Catalogo

Type Number	Part Number	Replacement/Remplacé par Ersatz / Sostituito da	Page	Type Number	Part Number	Replacement/Remplacé par Ersatz / Sostituito da	Page
SB6550	II39037F		166	SB7105	II34498	¹⁾	163
SB6550	II39039F	¹⁾	166	SB7105	II34898	¹⁾	163
SB6553	Z0011892	¹⁾	181	SB7108	II35396	¹⁾	163
SB6555	II39069F		167	SB7108	II38036F	¹⁾ SB7124 (II37814)	165
SB6556	II39252F		167	SB7109	II36430	¹⁾	163
SB6557	II39259F	²⁾	167	SB7112	II31985	¹⁾	162
SB6557	II39259FM1	¹⁾ SB6557 (II39259F)	167	SB7112	II31985M2	¹⁾ SB7112 (II31985)	162
SB6557	II39259FM2	¹⁾ SB6557 (II39259F)	167	SB7113	II32813	¹⁾	162
SB6558	II39267F	¹⁾	167	SB7113	II32813M2	¹⁾ SB7113 (II32813)	162
SB6558	II39267FM1	¹⁾ SB6558 (II39267F)	167	SB7115	II34899	¹⁾	163
SB6558	K000106	¹⁾	167	SB7118	II35397	¹⁾	163
SB6558	K000116	¹⁾	167	SB7118	II38037F	¹⁾ SB7134 (II37815)	165
SB6558	Z0011542	¹⁾	181	SB7119	II36431	¹⁾	163
SB6558	Z0017672	¹⁾	181	SB7120	II36503	¹⁾	163
SB6561	Z0010671	¹⁾	180	SB7122	II37423	¹⁾	165
SB6563	Z0017971	¹⁾	181	SB7122	II37423M1	¹⁾ SB7122 (II37423)	165
SB6566	K000210	¹⁾	168	SB7123	II37812	¹⁾	166
SB6566	K000212	¹⁾	168	SB7124	II37814	¹⁾	166
SB6567	K000300	¹⁾	168	SB7124	II39298F	¹⁾ SB7180 (Z0021121)	181
SB6571	Z0010672	¹⁾	180	SB7125	II37816	¹⁾	166
SB6573	Z0017972	¹⁾	181	SB7127	II38340F	¹⁾	166
SB6576	K000211	¹⁾	168	SB7127	II38340FM1	¹⁾ SB7127 (II38340F)	166
SB6576	K000213	¹⁾	168	SB7128	II38342F	¹⁾	166
SB6577	K000301	¹⁾	168	SB7129	II38344F	¹⁾ SB7182 (Z0021181)	182
SB6582	K000584	¹⁾	169	SB7130	II36504	¹⁾	163
SB6582	K002656	¹⁾ SB6582 (K003668)	173	SB7132	II37424	¹⁾	165
SB6582	K003668	¹⁾	173	SB7132	II37424M1	¹⁾ SB7132 (II37424)	165
SB6584	K001054	¹⁾	169	SB7133	II37813	¹⁾	166
SB6585	K004481	²⁾	173	SB7134	II37815	¹⁾	166
SB6586	K004483	¹⁾	173	SB7134	II39299F	¹⁾ SB7190 (Z0021122)	182
SB6592	K000585	¹⁾	169	SB7135	II37817	¹⁾	166
SB6592	K002657	¹⁾ SB6592 (K003669)	173	SB7137	II38341F	¹⁾	166
SB6592	K003669	¹⁾	173	SB7137	II38341FM1	¹⁾ SB7137 (II38341F)	166
SB6594	K001055	¹⁾	169	SB7138	II38343F	¹⁾	166
SB6595	K004482	²⁾	173	SB7139	II38345F	¹⁾ SB7192 (Z0021182)	182
SB6596	K004484	¹⁾	173	SB7140	II38648F	¹⁾	166
SB7005	II15235	¹⁾ SB7789 (II37791)	165	SB7144	II39002F	¹⁾	166
SB7015	II15498	¹⁾ SB7799 (II37792)	165	SB7146	II39006F	¹⁾	166
SB7022	II16060	¹⁾ SB7989 (II36490)	163	SB7146	II39844F	¹⁾ SB7169 (Z0021243)	182
SB7032	II16070	¹⁾ SB7999 (II36491)	163	SB7148	II39030F	¹⁾	166
SB7040	II18923	¹⁾ SB7989 (II36490)	163	SB7149	II39032F	¹⁾	166
SB7041	II31022	¹⁾	162	SB7150	II38649F	¹⁾	166
SB7050	II18924	¹⁾ SB7999 (II36491)	163	SB7154	II39003F	¹⁾	166
SB7051	II31023	¹⁾	162	SB7156	II39007F	¹⁾	166
SB7102	II31984	¹⁾	162	SB7156	II39845F	¹⁾ SB7179 (Z0021244)	182
SB7102	II31984M2	¹⁾ SB7102 (II31984)	162	SB7158	II39031F	¹⁾	166
SB7103	II32812	¹⁾	162	SB7159	II39033F	¹⁾	166
SB7103	II32812M2	¹⁾ SB7103 (II32812)	162	SB7167	Z0014981M1	¹⁾ SB7189 (K000262)	168

Products in Type Number order
Produkte, nach Typnummern geordnet

Classification des Produits par Type
Prodotti ordinati per Catalogo

Type Number	Part Number	Replacement/Remplacé par Ersatz / Sostituito da	Page	Type Number	Part Number	Replacement/Remplacé par Ersatz / Sostituito da	Page
SB7168	Z0021103	¹⁾	182	SB7202	K001590M2	¹⁾ SB7212 (K001590)	170
SB7169	Z0021241	¹⁾	182	SB7202	K008653	¹⁾	175
SB7169	Z0021243	¹⁾	182	SB7202	K009897	¹⁾	175
SB7177	Z0014982M1	¹⁾ SB7199 (K000263)	168	SB7202	K009899	¹⁾	175
SB7178	Z0021104	¹⁾	182	SB7202	K031440	²⁾	180
SB7179	Z0021242	¹⁾	182	SB7202	K031442	¹⁾	180
SB7179	Z0021244	¹⁾	182	SB7203	K001593	¹⁾	171
SB7180	Z0021121	²⁾	182	SB7203	K001593M2	¹⁾ SB7203 (K001593)	170
SB7180	Z0021123	¹⁾	182	SB7205	K001949	¹⁾	171
SB7181	Z0021141	¹⁾	182	SB7206	K003455	²⁾	173
SB7182	Z0021181	¹⁾	182	SB7208	K003849	¹⁾	173
SB7184	Z0021221	¹⁾	182	SB7208	K010166	²⁾	175
SB7185	K000035	¹⁾	167	SB7209	K003860	¹⁾	173
SB7185	K010164	²⁾	175	SB7209	K010654	²⁾	176
SB7186	K000037	¹⁾	167	SB7210	K000259	¹⁾	168
SB7187	K000039	¹⁾	167	SB7211	K000486	¹⁾	168
SB7187	K000041	¹⁾	167	SB7211	K010653	¹⁾	176
SB7187	K010172	²⁾	175	SB7212	K001590	¹⁾	170
SB7187	K047412	²⁾	180	SB7212	K008654	¹⁾	175
SB7188	K000166	¹⁾	168	SB7212	K009898	¹⁾	175
SB7189	K000262	¹⁾	168	SB7212	K009900	¹⁾	175
SB7189	K001591	¹⁾	171	SB7212	K031441	²⁾	180
SB7189	K008651	¹⁾	175	SB7212	K031443	¹⁾	180
SB7189	K009903	¹⁾	175	SB7213	K001594	¹⁾	171
SB7189	K031438	²⁾	180	SB7215	K001950	¹⁾	171
SB7190	Z0021122	²⁾	182	SB7216	K003456	²⁾	173
SB7190	Z0021124	¹⁾	182	SB7218	K003850	¹⁾	173
SB7191	Z0021142	¹⁾	182	SB7218	K010167	²⁾	175
SB7192	Z0021182	¹⁾	182	SB7219	K003861	¹⁾	173
SB7194	Z0021222	¹⁾	182	SB7219	K010655	²⁾	176
SB7195	K000036	¹⁾	167	SB7220	K006539	¹⁾	174
SB7195	K010165	²⁾	175	SB7220	K010656	¹⁾	176
SB7196	K000038	¹⁾	167	SB7220	K012276	¹⁾	177
SB7197	K000040	¹⁾	167	SB7220	K032543	²⁾	180
SB7197	K000042	¹⁾	167	SB7221	K008649	¹⁾	175
SB7197	K010173	²⁾	175	SB7221	K009901	¹⁾	175
SB7197	K047413	²⁾	180	SB7221	K031436	¹⁾	180
SB7198	K000167	¹⁾	168	SB7222	K008415	¹⁾	175
SB7199	K000263	¹⁾	168	SB7222	K010658	¹⁾	176
SB7199	K001592	¹⁾	171	SB7222	K012278	¹⁾	177
SB7199	K008652	¹⁾	175	SB7225	K010168	²⁾	175
SB7199	K009904	¹⁾	175	SB7226	K011311	²⁾	177
SB7199	K031439	²⁾	180	SB7227	K012001	²⁾	177
SB7200	K000258	¹⁾	168	SB7227	K012003	²⁾	177
SB7201	K000485	¹⁾	168	SB7227	K023210	²⁾	179
SB7201	K010652	¹⁾	176	SB7228	K012005	²⁾	177
SB7202	K001589	¹⁾	170	SB7228	K012007	²⁾	177
SB7202	K001589M2	¹⁾ SB7202 (K001589)	170	SB7230	K006540	¹⁾	174

Products in Type Number order
Produkte, nach Typnummern geordnet

Classification des Produits par Type
Prodotti ordinati per Catalogo

Type Number	Part Number	Replacement/Remplacé par Ersatz / Sostituito da	Page	Type Number	Part Number	Replacement/Remplacé par Ersatz / Sostituito da	Page
SB7230	K010657	1)	176	SB7580	II19723	1) SB7711 (II34324)	162
SB7230	K012277	1)	177	SB7580	II19725	1) SB7712 (II34326)	163
SB7230	K032544	2)	180	SB7580	II34592	1) SB7701 (II34323)	162
SB7231	K008650	1)	175	SB7586	II32935	1) SB7586 (II33432)	162
SB7231	K009902	1)	175	SB7586	II33432	1)	162
SB7231	K031437	1)	180	SB7586	II33432M1	1) SB7586 (II33432)	162
SB7232	K008416	1)	175	SB7588	II30175	1) SB7705 (II34456)	163
SB7232	K010659	1)	176	SB7589	II30401	1) SB7989 (II36490)	163
SB7232	K012279	1)	177	SB7590	II19724	1) SB7701 (II34323)	162
SB7235	K010169	2)	175	SB7590	II19726	1) SB7702 (II34325)	163
SB7236	K011312	2)	177	SB7590	II34593	1) SB7711 (II34324)	162
SB7237	K012002	2)	177	SB7596	II32936	1) SB7596 (II33433)	162
SB7237	K012004	2)	177	SB7596	II33433	1)	162
SB7237	K023211	2)	179	SB7596	II33433M1	1) SB7596 (II33433)	162
SB7238	K012006	2)	177	SB7598	II30400	1) SB7715 (II34457)	163
SB7238	K012008	2)	177	SB7599	II30402	1) SB7999 (II36491)	163
SB7406R	K002771	1)	172	SB7600	II39294F	1)	167
SB7408R	K002783	1)	172	SB7601	Z0015241	1)	181
SB7416R	K002772	1)	172	SB7602	Z0015261	1)	181
SB7418R	K002784	1)	172	SB7604	Z0021001	1)	181
SB7423R	K003386	1)	173	SB7607	K000378	1)	168
SB7424R	K005504	1)	174	SB7607	Z0021021	1)	181
SB7433R	K003387	1)	173	SB7608	Z0021041	1)	182
SB7434R	K005505	1)	174	SB7608	Z0021043	1)	182
SB7453R	K002968	1)	172	SB7611	Z0015242	1)	181
SB7463R	K002969	1)	172	SB7612	Z0015262	1)	181
SB7500	Z0021261	1)	182	SB7614	Z0021002	1)	181
SB7501	Z0001651	1)	180	SB7617	K000379	1)	168
SB7505	II17281	1) SB7789 (II37791)	165	SB7617	Z0021022	1)	182
SB7508	Z0021281		182	SB7618	Z0021042	1)	182
SB7509	K010650	1)	176	SB7618	Z0021044	1)	182
SB7509	Z0021301	1)	182	SB7621	K000487	1)	168
SB7510	Z0021262	1)	182	SB7621	Z0021081	1)	182
SB7511	Z0001652	1)	180	SB7623	Z0021161	1)	182
SB7515	II17282	1) SB7799 (II37792)	165	SB7624	II19707	1) SB7789 (II37791)	165
SB7518	Z0021282		182	SB7629	II31026	1) SB7989 (II36490)	163
SB7519	K010651	1)	176	SB7631	K000488	1)	168
SB7519	Z0021302	1)	182	SB7631	Z0021082	1)	182
SB7521	II17935	1) SB7989 (II36490)	163	SB7633	Z0021162	1)	182
SB7522	II17937	1) SB7989 (II36490)	163	SB7634	II19708	1) SB7799 (II37792)	165
SB7531	II17936	1) SB7999 (II36491)	163	SB7639	II31027	1) SB7999 (II36491)	163
SB7532	II17938	1) SB7999 (II36491)	163	SB7640	II31030	1) SB7789 (II37791)	165
SB7540	II18927	1) SB7989 (II36490)	163	SB7648	II32798	1)	162
SB7541	II18925	1) SB7989 (II36490)	163	SB7648	II35058	1) SB7648 (II32798)	162
SB7550	II18928	1) SB7999 (II36491)	163	SB7648	II35815	1) SB7648 (II38724F)	166
SB7551	II18926	1) SB7999 (II36491)	163	SB7648	II36689	1)	164
SB7564	II19451	1)	162	SB7648	II37061	1)	164
SB7574	II19452	1) SB7799 (II37792)	165	SB7648	II38724F	1)	166

Products in Type Number order
Produkte, nach Typnummern geordnet

Classification des Produits par Type
Prodotti ordinati per Catalogo

Type Number	Part Number	Replacement/Remplacé par Ersatz / Sostituito da	Page	Type Number	Part Number	Replacement/Remplacé par Ersatz / Sostituito da	Page
SB7648	II39848	¹⁾	167	SB7676	II33431	¹⁾	162
SB7648	K000310	¹⁾ SN7020 (K000306)	168	SB7676	II33431M1	¹⁾ SB7676 (II33431)	162
SB7648	K000312	¹⁾ SN7020 (K000308)	168	SB7678	II33631	¹⁾ SB7799 (II37792)	165
SB7649	II32800	¹⁾	162	SB7679	Z0016571	¹⁾	181
SB7649	II32800M1	¹⁾ SB7649 (II32800)	162	SB7680	II37006	¹⁾	164
SB7649	II35054	¹⁾ SB7649 (II32800)	162	SB7681	II32203	¹⁾	162
SB7649	II35813	¹⁾ SB7649 (II38726F)	166	SB7682	II33981	¹⁾	162
SB7649	II36691	¹⁾	164	SB7682	II33981M1	¹⁾ SB7682 (II33981)	162
SB7649	II38726F	¹⁾	166	SB7682	II33981M2	¹⁾ SB7682 (II33981)	162
SB7649	K000314	¹⁾ SN7022 (K000302)	168	SB7682	II33981V1	¹⁾	162
SB7649	K000316	¹⁾ SN7022 (K000304)	168	SB7682	II33981V2	¹⁾	162
SB7650	II31031	¹⁾ SB7799 (II37792)	165	SB7688	II34603	¹⁾	163
SB7658	II32799	¹⁾	162	SB7688	Z000652	¹⁾	180
SB7658	II32799M1	¹⁾ SB7658 (II32799)	162	SB7689	Z0016572	¹⁾	181
SB7658	II35057	¹⁾ SB7658 (II32799)	162	SB7690	II37007	¹⁾	164
SB7658	II35816	¹⁾ SB7658 (II38725F)	166	SB7691	II32204	¹⁾	162
SB7658	II36690	¹⁾	164	SB7692	II33982	¹⁾	163
SB7658	II37062	¹⁾	164	SB7692	II33982V1	¹⁾	163
SB7658	II38725F	¹⁾	166	SB7692	II33982V2	¹⁾	163
SB7658	II39849	¹⁾	167	SB7698	II34604	¹⁾	163
SB7658	K000311	¹⁾ SN7030 (K000307)	168	SB7698	Z000653	¹⁾	180
SB7658	K000313	¹⁾ SN7030 (K000309)	168	SB7701	II34323	¹⁾	163
SB7659	II32801	¹⁾	162	SB7702	II34325	¹⁾	163
SB7659	II32801M1	¹⁾ SB7659 (II32801)	162	SB7703	II34452	¹⁾	163
SB7659	II35053	¹⁾ SB7659 (II32801)	162	SB7703	II37015	¹⁾	164
SB7659	II35814	¹⁾ SB7659 (II38727F)	166	SB7704	II34454	¹⁾	163
SB7659	II36692	¹⁾	164	SB7704	II37017	¹⁾	164
SB7659	II37064	¹⁾	165	SB7704	K002057	¹⁾	171
SB7659	II38727F	¹⁾	166	SB7705	II34456	¹⁾	163
SB7659	K000315	¹⁾ SN7032 (K000303)	168	SB7707	II34594	¹⁾	163
SB7659	K000317	¹⁾ SN7032 (K000305)	168	SB7707	II37019	¹⁾	164
SB7660	II32802	¹⁾	162	SB7708	II34598	¹⁾	163
SB7660	II35056	¹⁾ SB7660 (II32802)	162	SB7708	II37419	¹⁾	165
SB7660	II36693	¹⁾	164	SB7709	II34464	¹⁾	163
SB7660	II38728F	¹⁾ SN7021 (Z0010003)	180	SB7711	II34324	¹⁾	163
SB7661	II32941	¹⁾ SB7729 (II35957)	163	SB7712	II34326	¹⁾	163
SB7665	II33420	¹⁾	162	SB7713	II34453	¹⁾	163
SB7665	II34894	¹⁾ SB7692 (II33982)	162	SB7713	II37016	¹⁾	164
SB7666	II33430	¹⁾	162	SB7714	II34455	¹⁾	163
SB7666	II33430M1	¹⁾ SB7666 (II33430)	162	SB7714	II37018	¹⁾	164
SB7668	II33438	¹⁾ SB7789 (II37791)	165	SB7714	K002058	¹⁾	171
SB7670	II32803	¹⁾	162	SB7715	II34457	¹⁾	163
SB7670	II35055	¹⁾ SB7670 (II32803)	162	SB7717	II34595	¹⁾	163
SB7670	II36694	¹⁾	164	SB7717	II37020	¹⁾	164
SB7670	II38729F	¹⁾ SN7031 (Z0010004)	180	SB7718	II34599	¹⁾	163
SB7671	II32942	¹⁾ SB7739 (II35958)	163	SB7718	II37420	¹⁾	165
SB7675	II33421	¹⁾	162	SB7719	II34465	¹⁾	163
SB7675	II34895	¹⁾ SB7682 (II33981)	162	SB7721	II34487	¹⁾	163

Products in Type Number order
Produkte, nach Typnummern geordnet

Classification des Produits par Type
Prodotti ordinati per Catalogo

Type Number	Part Number	Replacement/Remplacé par Ersatz / Sostituito da	Page	Type Number	Part Number	Replacement/Remplacé par Ersatz / Sostituito da	Page
SB7723	II34820	¹⁾	163	SB7767	Z0011471	¹⁾	181
SB7724	II35401	¹⁾	163	SB7770	II37000	¹⁾	164
SB7724	II35800	¹⁾ SB7724 (II39264F)	167	SB7770	II37078	¹⁾	165
SB7724	II38350F	¹⁾	166	SB7770	II39843	¹⁾	167
SB7724	II39264F	¹⁾	167	SB7771	II37002	¹⁾	164
SB7725	II35403	¹⁾ SB7725 (II37021)	164	SB7771	II38841FM1	¹⁾ SB7771 (II37002)	164
SB7725	II37021	¹⁾	164	SB7772	II37030	¹⁾	164
SB7726	II35540	¹⁾	163	SB7772	II39045F	¹⁾	167
SB7726	II37239	¹⁾ SB7608 (Z0021043)	181	SB7772	K000008	¹⁾	167
SB7729	II35957		163	SB7772	K000720	¹⁾	169
SB7731	II34488	¹⁾	163	SB7772	Z0011582	¹⁾	181
SB7733	II34821	¹⁾	163	SB7775	II37069	¹⁾ SB7775 (II38368F)	166
SB7734	II35402	¹⁾	163	SB7775	II37210	¹⁾ SB7775 (II38368F)	166
SB7734	II35801	¹⁾ SB7734 (II39265F)	167	SB7775	II38368F	¹⁾	166
SB7734	II38351F	¹⁾	166	SB7776	II37071	¹⁾ SB7776 (II38731F)	166
SB7734	II39265F	¹⁾	167	SB7776	II38731F	¹⁾	166
SB7735	II35404	¹⁾ SB7735 (II37022)	164	SB7776	II39001F	¹⁾	166
SB7735	II37022	¹⁾	164	SB7776	K000816	¹⁾	169
SB7736	II35541	¹⁾	163	SB7776	K000831	²⁾	169
SB7736	II37240	¹⁾ SB7618 (Z0021044)	181	SB7776	K005714	¹⁾	174
SB7739	II35958		163	SB7777	II37081	¹⁾	165
SB7742	II35964	¹⁾	163	SB7777	II37081M1	¹⁾ SB7777 (II37081)	164
SB7752	II35965	¹⁾	163	SB7777	II37422	¹⁾ SB7777 (Z0011472)	180
SB7757	II36805	¹⁾	164	SB7777	Z0011472	¹⁾	181
SB7757	II37699	¹⁾	165	SB7780	II37231	¹⁾	165
SB7760	II36999	¹⁾	164	SB7780	II39846	¹⁾ SN7083 (K000786)	169
SB7760	II37077	¹⁾	165	SB7782	II37246	¹⁾	165
SB7760	II39842	¹⁾	167	SB7783	II37380	¹⁾	165
SB7761	II37001	¹⁾	164	SB7784	II37390	¹⁾	165
SB7761	II38840FM1	¹⁾ SB7761 (II37001)	164	SB7785	II37392	¹⁾	165
SB7762	II37029	¹⁾	164	SB7787	II37398	¹⁾	165
SB7762	II39044F	¹⁾	166	SB7787	II37398M1	¹⁾ SB7787 (II37398)	165
SB7762	K000007	¹⁾	167	SB7787	II37398M2	¹⁾ SB7787 (II37398)	165
SB7762	K000719	¹⁾	169	SB7789	II37791	¹⁾	165
SB7762	Z0011581	¹⁾	181	SB7790	II37232	¹⁾	165
SB7765	II37068	¹⁾ SB7765 (II38367F)	166	SB7790	II39847	¹⁾ SN7093 (K000787)	169
SB7765	II37209	¹⁾ SB7765 (II38367F)	166	SB7792	II37247	¹⁾	165
SB7765	II38367F	¹⁾	166	SB7793	II37381	¹⁾	165
SB7765	II38367FM1	¹⁾ SB7828 (II39544F)	167	SB7794	II37391	¹⁾	165
SB7766	II37070	¹⁾ SB7766 (II38730F)	166	SB7795	II37393	¹⁾	165
SB7766	II38730F	¹⁾	166	SB7797	II37399	¹⁾	165
SB7766	II39000F	¹⁾	166	SB7797	II37399M2	¹⁾ SB7797 (II37399)	165
SB7766	K000815	¹⁾	169	SB7799	II37792	¹⁾	165
SB7766	K000830	²⁾	169	SB7800	II37793	¹⁾	165
SB7766	K005713	¹⁾	174	SB7800	II38352F	¹⁾	166
SB7767	II37080	¹⁾	165	SB7800	II38810F	¹⁾	166
SB7767	II37080M1	¹⁾ SB7767 (II37080)	164	SB7800	Z0017521	¹⁾	181
SB7767	II37421	¹⁾ SB7767 (Z0011471)	180	SB7800	Z0017523	¹⁾	181

Products in Type Number order
Produkte, nach Typnummern geordnet

Classification des Produits par Type
Prodotti ordinati per Catalogo

Type Number	Part Number	Replacement/Remplacé par Ersatz / Sostituito da	Page	Type Number	Part Number	Replacement/Remplacé par Ersatz / Sostituito da	Page
SB7800	Z0029181	¹⁾ SB7800 (Z0017521)	181	SB7852	Z0010962	¹⁾	181
SB7800	Z0029183	¹⁾ SB7800 (Z0017523)	181	SB7858	Z0009801	¹⁾	180
SB7801	II37808	¹⁾	165	SB7859	Z0009751	¹⁾	180
SB7801	II37808M1	¹⁾ SB7801 (II37808)	165	SB7860	Z0015711	¹⁾	181
SB7801	II38046F	¹⁾ Z0011491AT	180	SB7861	Z0015731	¹⁾	181
SB7801	K000091	¹⁾	167	SB7862	Z0015751	¹⁾	181
SB7801	Z0011491	¹⁾	181	SB7863	Z0017951	¹⁾	181
SB7803	II38038F	¹⁾	166	SB7865	II40232F	¹⁾	167
SB7806	II38363F	¹⁾	166	SB7868	Z0009802	¹⁾	180
SB7807	II38630F	¹⁾	166	SB7869	Z0009752	¹⁾	180
SB7807	II38630FM1	¹⁾ SB7829 (Z000276)	180	SB7870	Z0015712	¹⁾	181
SB7807	II38631FM1	¹⁾ SB7839 (Z000277)	180	SB7872	Z0015752	¹⁾	181
SB7809	II38634F	¹⁾	166	SB7873	Z0017952	¹⁾	181
SB7810	II37794	¹⁾	165	SB7875	II40233F	¹⁾	167
SB7810	II38353F	¹⁾	166	SB7880	K000002	¹⁾	167
SB7810	II38811F	¹⁾	166	SB7880	K000386	¹⁾	168
SB7810	Z0017522	¹⁾	181	SB7881	K000011		167
SB7810	Z0017524	¹⁾	181	SB7883	K000043	²⁾	167
SB7810	Z0029182	¹⁾ SB7810 (Z0017522)	181	SB7884	K000045	¹⁾	167
SB7810	Z0029184	¹⁾ SB7810 (Z0017524)	181	SB7886	K000051	²⁾	167
SB7811	II37809	¹⁾	166	SB7887	K000053	¹⁾	167
SB7811	II37809M1	¹⁾ SB7811 (II37809)	165	SB7888	Z0013571	¹⁾	181
SB7811	II38047F	¹⁾ Z0011492AT	180	SB7889	Z0013591	¹⁾	181
SB7811	K000092	¹⁾	167	SB7889	Z0013591M1	¹⁾ SB7889 (Z0013591)	181
SB7811	Z0011492	¹⁾	181	SB7890	K000003	¹⁾	167
SB7813	II38039F	¹⁾	166	SB7890	K000387	¹⁾	168
SB7816	II38364F	¹⁾	166	SB7891	K000012		167
SB7817	II38631F	¹⁾	166	SB7893	K000044	²⁾	167
SB7819	II38635F	¹⁾	166	SB7894	K000046	¹⁾	167
SB7820	II38816F	¹⁾	166	SB7896	K000052	²⁾	167
SB7824	Z000981	¹⁾	180	SB7897	K000054	¹⁾	167
SB7825	II39034F		166	SB7898	Z0013572	¹⁾	181
SB7826	II39262F	¹⁾	167	SB7899	Z0013592	¹⁾	181
SB7828	II39544F	¹⁾	167	SB7899	Z0013592M1	¹⁾ SB7899 (Z0013592)	181
SB7828	II39544FM1	¹⁾ SB7862 (Z0015751)	181	SB7900	K000136	¹⁾	167
SB7829	Z000276	¹⁾	180	SB7901	K000138	¹⁾	168
SB7829	Z000276M1	¹⁾ SB7861 (Z0015731)	181	SB7901	K000550	¹⁾	169
SB7829	Z000276M2	¹⁾ SB7861 (Z0015731)	181	SB7901	K002118	¹⁾	171
SB7829	Z000277M1	¹⁾ Z0015732	181	SB7902	K000260	²⁾	168
SB7830	II38817F	¹⁾	166	SB7902	K000260M1	¹⁾ SB7902 (K000260)	168
SB7834	Z000982	¹⁾	180	SB7903	K000517	¹⁾	168
SB7835	II39035F		166	SB7903	K002144	¹⁾	171
SB7836	II39263F	¹⁾	167	SB7904	K000320	¹⁾	168
SB7838	II39545F	¹⁾	167	SB7906	K000412		168
SB7838	II39545FM1	¹⁾ SB7872 (Z0015752)	181	SB7909	K000552	¹⁾	169
SB7839	Z000277	¹⁾	180	SB7910	K000137	¹⁾	168
SB7839	Z000277M2	¹⁾ Z0015732	181	SB7911	K000139	¹⁾	168
SB7842	Z0010961	¹⁾	181	SB7911	K000551	¹⁾	169

Products in Type Number order
Produkte, nach Typnummern geordnet

Classification des Produits par Type
Prodotti ordinati per Catalogo

Type Number	Part Number	Replacement/Remplacé par Ersatz / Sostituito da	Page	Type Number	Part Number	Replacement/Remplacé par Ersatz / Sostituito da	Page
SB7911	K002119	¹⁾	171	SIV-10K	I67981		192
SB7912	K000261	²⁾	168	SK7001	K001908	¹⁾	171
SB7912	K000261M1	¹⁾ SB7912 (K000261)	168	SK7001	K009746	¹⁾	175
SB7913	K000518	¹⁾	169	SK7002	K003400	¹⁾	173
SB7913	K002145	¹⁾	171	SK7002	K013873	²⁾	178
SB7914	K000321	¹⁾	168	SK7003	K003402	¹⁾	173
SB7916	K000413		168	SK7004	K003453	¹⁾	173
SB7919	K000553	¹⁾	169	SK7004	K009744	¹⁾	175
SB7929	K000822	¹⁾	169	SK7006	K004674	²⁾	173
SB7939	K000823	¹⁾	169	SK7007	K010277	²⁾	175
SB7940	K000826		169	SK7009	K015086	¹⁾	178
SB7942	K001228	¹⁾	170	SK7009	K023796	²⁾	179
SB7942	K010170	¹⁾	175	SK7011	K001909	¹⁾	171
SB7943	K001352	¹⁾ SN7121 (K001225)	170	SK7011	K009747	¹⁾	175
SB7948	K001362	¹⁾	170	SK7012	K003401	¹⁾	173
SB7948	K001364	¹⁾	170	SK7012	K013874	²⁾	178
SB7950	K000827		169	SK7013	K003403	¹⁾	173
SB7952	K001229	¹⁾	170	SK7014	K003454	¹⁾	173
SB7952	K010171	¹⁾	175	SK7014	K009745	¹⁾	175
SB7953	K001353	¹⁾ SN7131 (K001226)	170	SK7016	K004675	²⁾	173
SB7958	K001363	¹⁾	170	SK7017	K010278	²⁾	175
SB7958	K001365	¹⁾	170	SK7019	K015087	¹⁾	178
SB7960	K001460	¹⁾	170	SK7019	K023797	²⁾	179
SB7962	K002010	¹⁾	171	SK7025	K021666	¹⁾	179
SB7963	K002012	¹⁾	171	SK7025	K028024	²⁾	180
SB7964	K002306	¹⁾	171	SK7026	K001481	²⁾	170
SB7965	K002375		172	SK7028	K011545		177
SB7966	K023627	²⁾	179	SK7029	K011547	²⁾	177
SB7970	K001461	¹⁾	170	SK7035	K021667	¹⁾	179
SB7972	K002011	¹⁾	171	SK7035	K028025	²⁾	180
SB7973	K002013	¹⁾	171	SK7036	K001482	²⁾	170
SB7974	K002307	¹⁾	171	SK7038	K011546		177
SB7975	K002376		172	SK7039	K011548	²⁾	177
SB7976	K023628	²⁾	179	SK7041	K012341	²⁾	177
SB7989	II36490	¹⁾	163	SK7051	K012342	²⁾	177
SB7999	II36491	¹⁾	163	SM1B	SM1B	²⁾ SM1PLB (K022028N00)	49, 208
SC2CK	K010198		215	SM1LA	K044312S01	²⁾	208
SC4A	K009936		215	SM1PLB	K022028N00		49, 208
SC5A	K017419N00		215	SM1PLD	K015237N00		49, 208
SC6A	K017436N00		215	SM2AA	K009316	²⁾ SM2PA (K044874N00)	49, 208
SF17	1409284	²⁾ SF17 (1409284C)	208	SM2DK	K010849	²⁾ SM2PD (K044873N00)	49, 50, 208
SF17	1409284C		208	SM2PA	K044874N00		49, 208
SF18	1409285	²⁾ SF18 (1409285C)	208	SM2PD	K044873N00		49, 50, 208
SF18	1409285C		208	SN5001	K000281	¹⁾	168
SF3	1407023	²⁾ SF3 (1407023C)	208	SN5001	K001942	¹⁾	171
SF3	1407023C		208	SN5001	K001944	¹⁾	171
SF42	1422762	²⁾ SF42 (1422762C)	208	SN5001	K003301	¹⁾	172
SF42	1422762C		208	SN5001	K011178	¹⁾	176

Products in Type Number order
Produkte, nach Typnummern geordnet

Classification des Produits par Type
Prodotti ordinati per Catalogo

Type Number	Part Number	Replacement/Remplacé par Ersatz / Sostituito da	Page	Type Number	Part Number	Replacement/Remplacé par Ersatz / Sostituito da	Page
SN5001	K011180	2)	176	SN5032	K011552		177
SN5001	K011237	2)	176	SN6500	K005968	1)	174
SN5001	K011240	2)	176	SN6500	K011796	2)	177
SN5001	K015972	1)	179	SN6500	K017172	2)	179
SN5001	K016618	2)	179	SN6504	K001763	1)	171
SN5001	K016621	2)	179	SN6504	K001765	1)	171
SN5001	K016622	2)	179	SN6504	K001767	1)	171
SN5001	K016626	2)	179	SN6504	K001769	1)	171
SN5002	K001747	1)	171	SN6504	K002063	1)	171
SN5002	K001749	2)	171	SN6504	K002065	1)	171
SN5002	K010793	2)	176	SN6504	K009912	1)	175
SN5002	K011262	2)	176	SN6504	K009914	1)	175
SN5002	K011264	2)	176	SN6504	K015806DC	2)	179
SN5003	K001751	1)	171	SN6507	K001545	1)	170
SN5003	K001753	1)	171	SN6507	K003662	1)	173
SN5003	K010694		176	SN6507	K004526	1)	173
SN5003	K010791	2)	176	SN6507	K014935	1)	178
SN5003	K011258		176	SN6507	K014937	1)	178
SN5003	K011260	2)	176	SN6507	K019013	1)	179
SN5007	K004733		173	SN6508	K000715	1)	169
SN5011	K000282	1)	168	SN6509	K005970	2)	174
SN5011	K001943	1)	171	SN6510	K005969	1)	174
SN5011	K001945	1)	171	SN6510	K011797	2)	177
SN5011	K003302	1)	172	SN6510	K017173	2)	179
SN5011	K011179	1)	176	SN6514	K001764	1)	171
SN5011	K011181	2)	176	SN6514	K001766	1)	171
SN5011	K011238	2)	176	SN6514	K001768	1)	171
SN5011	K011239	2)	176	SN6514	K001770	1)	171
SN5011	K015973	1)	179	SN6514	K002064	1)	171
SN5011	K016619	2)	179	SN6514	K002066	1)	171
SN5011	K016620	2)	179	SN6514	K009913	1)	175
SN5011	K016623	2)	179	SN6514	K009915	1)	175
SN5011	K016627	2)	179	SN6514	K015807DC	2)	179
SN5012	K001748	1)	171	SN6517	K001546	1)	170
SN5012	K001750	1)	171	SN6517	K003663	1)	173
SN5012	K010794	2)	176	SN6517	K004527	1)	173
SN5012	K011261	2)	176	SN6517	K014936	1)	178
SN5012	K011263	2)	176	SN6517	K014938	1)	178
SN5013	K001752	1)	171	SN6517	K019014	1)	179
SN5013	K001754	1)	171	SN6518	K000716	1)	169
SN5013	K010695		176	SN6519	K005971	2)	174
SN5013	K010792	2)	176	SN6527	K001079	2)	169
SN5013	K011257		176	SN6527	K001081		169
SN5013	K011259		176	SN6527	K001083	1)	169
SN5017	K004734		174	SN6527	K001085		169
SN5021	K011549	2)	177	SN6528	K001087	1)	169
SN5022	K011551		177	SN6528	K001089	1)	169
SN5031	K011550	2)	177	SN6528	K001091	1)	169

Products in Type Number order
Produkte, nach Typnummern geordnet

Classification des Produits par Type
Prodotti ordinati per Catalogo

Type Number	Part Number	Replacement/Remplacé par Ersatz / Sostituito da	Page	Type Number	Part Number	Replacement/Remplacé par Ersatz / Sostituito da	Page
SN6528	K001093	¹⁾	170	SN6551	K025626	²⁾	180
SN6529	K001117	¹⁾	170	SN6551	K032586	²⁾	180
SN6529	K002654	¹⁾ SN6529 (K003672)	173	SN6552	K001339	²⁾	170
SN6529	K002934	¹⁾	172	SN6552	K002515	¹⁾	172
SN6529	K003672	¹⁾	173	SN6552	K014941	¹⁾	178
SN6529	K004161		173	SN6553	K001341	¹⁾	170
SN6529	K014939	¹⁾	178	SN6555	K001441	²⁾	170
SN6537	K001080	²⁾	169	SN6555	K003057	²⁾	172
SN6537	K001082		169	SN6556	K001443	¹⁾	170
SN6537	K001084	¹⁾	169	SN6556	K013870	²⁾	178
SN6537	K001086		169	SN6557	K001445	¹⁾	170
SN6538	K001088	¹⁾	169	SN6557	K013872	¹⁾	178
SN6538	K001090	¹⁾	169	SN6557R	K003791		173
SN6538	K001092	¹⁾	170	SN6558R	K003793		173
SN6538	K001094	¹⁾	170	SN6560	K002060	¹⁾	171
SN6539	K001118	¹⁾	170	SN6560	K002062	¹⁾	171
SN6539	K002655	¹⁾ SN6539 (K003673)	173	SN6560	K009884	¹⁾	175
SN6539	K002935	¹⁾	172	SN6560	K009911	¹⁾	175
SN6539	K003673	¹⁾	173	SN6560	K015805DC	²⁾	179
SN6539	K004162		173	SN6561	K002108	¹⁾	171
SN6539	K014940	¹⁾	178	SN6561	K013819	²⁾	178
SN6541	K001175	¹⁾	170	SN6561	K025627	²⁾	180
SN6541	K001177	¹⁾	170	SN6562	K002516	¹⁾	172
SN6541	K003715	¹⁾	173	SN6562	K014942	¹⁾	178
SN6541	K003717	¹⁾	173	SN6567R	K003792		173
SN6541	K012731	¹⁾	177	SN6568R	K003794		173
SN6541	K032585	²⁾	180	SN6569	K003856	²⁾	173
SN6542	K001338	²⁾	170	SN6571R	K013204	¹⁾	177
SN6543	K001340	¹⁾	170	SN6574	K004758	¹⁾	174
SN6545	K001440	²⁾	170	SN6575	K006843	²⁾	174
SN6545	K003056	²⁾	172	SN6577	K011537		177
SN6546	K001442	¹⁾	170	SN6577	K040911	²⁾	180
SN6546	K013869	²⁾	178	SN6578	K011539		177
SN6547	K001444	¹⁾	170	SN6579	K003857	²⁾	173
SN6547	K013871	¹⁾	178	SN6581R	K013203	¹⁾	177
SN6549	K001955	¹⁾	171	SN6584	K004759	¹⁾	174
SN6550	K002059	¹⁾	171	SN6585	K006844	²⁾	174
SN6550	K002061	¹⁾	171	SN6587	K011538		177
SN6550	K009883	¹⁾	175	SN6587	K040912	²⁾	180
SN6550	K009910	¹⁾	175	SN6588	K011540		177
SN6550	K015804DC	²⁾	179	SN6589	K012733	¹⁾	177
SN6551	K001176	¹⁾	170	SN6590	K011541	²⁾	177
SN6551	K001178	¹⁾	170	SN6592	K012345	²⁾	177
SN6551	K002107	¹⁾	171	SN6594	K013152	²⁾	177
SN6551	K003716	¹⁾	173	SN6594	K013154	²⁾	177
SN6551	K003718	¹⁾	173	SN6596	K013576	²⁾	177
SN6551	K012732	¹⁾	177	SN6597	K014513	²⁾	178
SN6551	K013818	²⁾	178	SN6599	K012734	¹⁾	177

Products in Type Number order
Produkte, nach Typnummern geordnet

Classification des Produits par Type
Prodotti ordinati per Catalogo

Type Number	Part Number	Replacement/Remplacé par Ersatz / Sostituito da	Page	Type Number	Part Number	Replacement/Remplacé par Ersatz / Sostituito da	Page
SN6600	K011542	2)	177	SN7022	K002337	1)	172
SN6602	K012346	2)	177	SN7022	K002339	1)	172
SN6604	K013153	2)	177	SN7022	K002341	1)	172
SN6604	K013155	2)	177	SN7022	K002343	1)	172
SN6606	K013577	2)	177	SN7022	K002345	1)	172
SN6607	K014514	2)	178	SN7022	K002347	1)	172
SN6628	K024731	2)	179	SN7022	K004276	1)	173
SN6629	K024733	2)	179	SN7022	K004278	1)	173
SN6630	K024735	2)	179	SN7022	K007151	1)	174
SN6631	K024737	2)	179	SN7022	K007153	2)	174
SN6638	K024732	2)	179	SN7022	K007159	1)	174
SN6639	K024734	2)	179	SN7022	K010149	2)	175
SN6640	K024736	2)	179	SN7022	K010151	2)	175
SN6641	K024738	2)	180	SN7022	Z0010291	1)	180
SN7020	K000202	1)	168	SN7022	Z0010293	1)	180
SN7020	K000204	1)	168	SN7028	K000790	1)	169
SN7020	K000306	1)	168	SN7028	K015425	2)	179
SN7020	K000308	1)	168	SN7028	K015427		179
SN7020	K002353	1)	172	SN7028	K015429	2)	179
SN7020	K002355	1)	172	SN7028	Z0010911	1)	180
SN7020	K002357	1)	172	SN7028	Z0010913	1)	181
SN7020	K002359	1)	172	SN7029	K000445	1)	168
SN7020	K002361	1)	172	SN7029	K000447	1)	168
SN7020	K002363	1)	172	SN7029	K000449	1)	168
SN7020	K007088	2)	174	SN7029	K014334	2)	178
SN7020	K007090	1)	174	SN7029	K014336	2)	178
SN7020	K007092	2)	174	SN7029	K014338	2)	178
SN7020	K007094	2)	174	SN7030	K000203	1)	168
SN7020	K007096	2)	174	SN7030	K000205	1)	168
SN7020	K007098	1)	174	SN7030	K000307	1)	168
SN7020	Z000723	1)	180	SN7030	K000309	1)	168
SN7020	Z000723M5	1) SN7020 (Z000723)	180	SN7030	K002354	1)	172
SN7020	Z000723M6	1) SN7020 (Z000723)	180	SN7030	K002356	1)	172
SN7020	Z000725	1)	180	SN7030	K002358	1)	172
SN7021	K002349	1)	172	SN7030	K002360	1)	172
SN7021	K002351	1)	172	SN7030	K002362	1)	172
SN7021	K007187		174	SN7030	K002364	1)	172
SN7021	K007189	2)	174	SN7030	K007089	2)	174
SN7021	K010147	2)	175	SN7030	K007091	1)	174
SN7021	K010897		176	SN7030	K007093	2)	174
SN7021	K010899	2)	176	SN7030	K007095	2)	174
SN7021	K010901	2)	176	SN7030	K007097	2)	174
SN7021	Z0010001	1)	180	SN7030	K007099	1)	174
SN7021	Z0010003	1)	180	SN7030	Z000724	1)	180
SN7022	K000206	1)	168	SN7030	Z000724M5	1) SN7030 (Z000724)	180
SN7022	K000208	1)	168	SN7030	Z000724M6	1) SN7030 (Z000724)	180
SN7022	K000302	1)	168	SN7030	Z000726	1)	180
SN7022	K000304	1)	168	SN7031	K002350	1)	172

Products in Type Number order
Produkte, nach Typnummern geordnet

Classification des Produits par Type
Prodotti ordinati per Catalogo

Type Number	Part Number	Replacement/Remplacé par Ersatz / Sostituito da	Page	Type Number	Part Number	Replacement/Remplacé par Ersatz / Sostituito da	Page
SN7031	K002352	1)	172	SN7041	K005077	1)	174
SN7031	K007188		174	SN7041	K009083	1)	175
SN7031	K007190	2)	174	SN7041	K031426	2)	180
SN7031	K010148	2)	175	SN7041	K045318	2)	180
SN7031	K010898		176	SN7041	Z0013631	1) SN7041 (K001654)	170
SN7031	K010900	2)	176	SN7042	K000849	1)	169
SN7031	K010902	2)	176	SN7042	K004623	1)	173
SN7031	Z0010002	1)	180	SN7042	K007767	2)	174
SN7031	Z0010004	1)	180	SN7042	K016829	2)	179
SN7032	K000207	1)	168	SN7042	K019136	1)	179
SN7032	K000209	1)	168	SN7042	Z0017261	1)	181
SN7032	K000303	1)	168	SN7045	K000266	1)	168
SN7032	K000305	1)	168	SN7045	K001661	1) SN7045 (K005079)	173
SN7032	K002338	1)	172	SN7045	K005079	1)	174
SN7032	K002340	1)	172	SN7045	K009087	1) SN7045 (K005079)	173
SN7032	K002342	1)	172	SN7045	K031434	2)	180
SN7032	K002344	1)	172	SN7045	K045324	2)	180
SN7032	K002346	1)	172	SN7046	K000605	2)	169
SN7032	K002348	1)	172	SN7047	K000771	1)	169
SN7032	K004277	1)	173	SN7047	K000773	1)	169
SN7032	K004279	1)	173	SN7047	K011134	2)	176
SN7032	K007152	1)	174	SN7047	K011136	2)	176
SN7032	K007154	2)	174	SN7048	K000775	1)	169
SN7032	K007156	2)	174	SN7049	K000778	1)	169
SN7032	K007160	1)	174	SN7049	K003353	2)	173
SN7032	K010150	2)	175	SN7050	K001660	1)	171
SN7032	K010152	2)	175	SN7050	K003853	1)	173
SN7032	Z0010292	1)	180	SN7050	K009086	1)	175
SN7032	Z0010294	1)	180	SN7050	K031431	2)	180
SN7038	K000791	1)	169	SN7050	K045323	2)	180
SN7038	K015426	2)	179	SN7050	Z0013612	1)	181
SN7038	K015428	2)	179	SN7051	K001655	1)	171
SN7038	K015430	2)	179	SN7051	K005078	1)	174
SN7038	Z0010912	1)	180	SN7051	K009084	1)	175
SN7038	Z0010914	1)	181	SN7051	K031427	2)	180
SN7039	K000446	1)	168	SN7051	K045319	2)	180
SN7039	K000448	1)	168	SN7051	Z0013632	1) SN7051 (K001655)	170
SN7039	K000450	1)	168	SN7052	K000850	1)	169
SN7039	K014335	2)	178	SN7052	K004624	1)	173
SN7039	K014337	2)	178	SN7052	K007768	2)	174
SN7039	K014339	2)	178	SN7052	K016830	2)	179
SN7040	K001659	1) SN7040 (K009085)	174	SN7052	K019137	1)	179
SN7040	K003852	1)	173	SN7052	Z0017262	1)	181
SN7040	K009085	1)	175	SN7055	K000267	1)	168
SN7040	K031430	2)	180	SN7055	K001662	1) SN7055 (K005080)	173
SN7040	K045322	2)	180	SN7055	K005080	1)	174
SN7040	Z0013611	1)	181	SN7055	K009088	1)	175
SN7041	K001654	1)	171	SN7055	K031435	2)	180

Products in Type Number order
Produkte, nach Typnummern geordnet

Classification des Produits par Type
Prodotti ordinati per Catalogo

Type Number	Part Number	Replacement/Remplacé par Ersatz / Sostituito da	Page	Type Number	Part Number	Replacement/Remplacé par Ersatz / Sostituito da	Page
SN7055	K045325	2)	180	SN7086	K014987	2)	178
SN7056	K000606	2)	169	SN7086	K014991	2)	178
SN7057	K000772	1)	169	SN7086	K014997	2)	178
SN7057	K000774	1)	169	SN7087	K011872	2)	177
SN7057	K011135	2)	176	SN7090	K000781	1)	169
SN7057	K011137	2)	176	SN7090	K011667	2)	177
SN7058	K000776	1)	169	SN7090	K015235	2)	179
SN7059	K000779	1)	169	SN7091	K000783	1)	169
SN7059	K003352	2)	173	SN7091	K001420	1)	170
SN7066	K000474	1)	168	SN7091	K001422	1)	170
SN7066	K000851	2)	169	SN7091	K003347	1)	172
SN7066	K004625	1)	173	SN7091	K003349	1)	172
SN7066	K007765	2)	174	SN7091	K003351	1)	173
SN7066	K016827	2)	179	SN7091	K008169	2)	174
SN7067	K000476	1)	168	SN7091	K008171	2)	174
SN7067	K011176	2)	176	SN7091	K008173	2)	175
SN7067	K023735	2)	179	SN7093	K000787	1)	169
SN7076	K000475	1)	168	SN7093	K000787AT	1) K003250AT	172
SN7076	K000852	2)	169	SN7094	K000871	1)	169
SN7076	K004626	1)	173	SN7094	K002659	1) SN7094 (K003671)	173
SN7076	K007766	2)	174	SN7094	K003671	1)	173
SN7076	K016828	2)	179	SN7094	K009280	1)	175
SN7077	K000477	1)	168	SN7095	K000873	1)	169
SN7077	K011177	2)	176	SN7095	K011171	2)	176
SN7077	K023736	2)	179	SN7096	K000994	1)	169
SN7080	K000780	1)	169	SN7096	K002572	1)	172
SN7080	K011666	2)	177	SN7096	K010154	1)	175
SN7080	K015234	2)	178	SN7096	K014988	2)	178
SN7081	K000782	1)	169	SN7096	K014992	2)	178
SN7081	K001419	1)	170	SN7096	K014998	2)	178
SN7081	K001421	1)	170	SN7097	K011873	2)	177
SN7081	K003346	1)	172	SN7101	K001038	1)	169
SN7081	K003348	1)	172	SN7101	K011174	2)	176
SN7081	K003350	1)	172	SN7102	K001051	1)	169
SN7081	K008168	2)	174	SN7102	K002660	1)	172
SN7081	K008170	2)	174	SN7102	K003666	1)	173
SN7081	K008172	2)	174	SN7102	K009283	1)	175
SN7083	K000786	1)	169	SN7104	K001077	2)	169
SN7083	K000786AT	1) K003249AT	172	SN7104	K003830	2)	173
SN7084	K000870	1)	169	SN7105	K001115	1)	170
SN7084	K002658	1) SN7084 (K003670)	173	SN7105	K013879	2)	178
SN7084	K003670	1)	173	SN7106	K001140	1)	170
SN7084	K009279	1)	175	SN7106	K001142	1)	170
SN7085	K000872	1)	169	SN7106	K013883		178
SN7085	K011170	2)	176	SN7107	K001164	1)	170
SN7086	K000993	1)	169	SN7107	K002983	1)	172
SN7086	K002571	1)	172	SN7107	K011138	2)	176
SN7086	K010153	1)	175	SN7107	K011140	2)	176

Products in Type Number order
Produkte, nach Typnummern geordnet

Classification des Produits par Type
Prodotti ordinati per Catalogo

Type Number	Part Number	Replacement/Remplacé par Ersatz / Sostituito da	Page	Type Number	Part Number	Replacement/Remplacé par Ersatz / Sostituito da	Page
SN7108	K013592	2)	177	SN7137	K001317	1)	170
SN7111	K001039	1)	169	SN7137	K014990	2)	178
SN7111	K011175	2)	176	SN7139	K001371	1)	170
SN7112	K001052	1)	169	SN7139	K001371M1	1) SN7139 (K001371)	170
SN7112	K002661	1)	172	SN7139	K013886	1)	178
SN7112	K003667	1)	173	SN7140	K001372	1)	170
SN7112	K009284	1)	175	SN7140	K013887	1)	178
SN7114	K001078	2)	169	SN7141	K001374	1)	170
SN7114	K003831	2)	173	SN7141	K013889	2)	178
SN7115	K001116	1)	170	SN7142	K001413	1)	170
SN7115	K013880	2)	178	SN7142	K013807	2)	177
SN7116	K001141	1)	170	SN7143	K001451		170
SN7116	K001143	1)	170	SN7144	K001475	1)	170
SN7116	K013884		178	SN7144	K014651	2)	178
SN7117	K001165	1)	170	SN7144	K014653	2)	178
SN7117	K002984	1)	172	SN7146	K001951	2)	171
SN7117	K011139	2)	176	SN7147	K001953	1)	171
SN7117	K011141	2)	176	SN7150	K001373	1)	170
SN7118	K001170	1)	170	SN7150	K001373M1	1) SN7150 (K001373)	170
SN7118	K013593	2)	177	SN7150	K013888	1)	178
SN7121	K001225	1)	170	SN7151	K001375	1)	170
SN7122	K001232	1)	170	SN7151	K013890	2)	178
SN7122	K011668	2)	177	SN7152	K001414	1)	170
SN7123	K001289	1)	170	SN7152	K013808	2)	178
SN7123	K011172	2)	176	SN7153	K001452		170
SN7124	K001291	1)	170	SN7154	K001476	1)	170
SN7125	K001312	1)	170	SN7154	K014652	2)	178
SN7125	K014999	2)	178	SN7154	K014654	2)	178
SN7126	K001314	1)	170	SN7156	K001952	2)	171
SN7126	K002575	1)	172	SN7157	K001954	1)	171
SN7126	K015001	2)	178	SN7160	K002099	1)	171
SN7126	K015003	2)	178	SN7160	K010749	1)	176
SN7127	K001316	1)	170	SN7160	K011670	2)	177
SN7127	K014989	2)	178	SN7163	K002167	1)	171
SN7129	K001370	1)	170	SN7163	K013891		178
SN7129	K013885	1)	178	SN7164	K002246	1)	171
SN7131	K001226	1)	170	SN7164	K003664	1)	173
SN7132	K001233	1)	170	SN7164	K009281	1)	175
SN7132	K011669	2)	177	SN7165	K002222	1)	171
SN7133	K001290	1)	170	SN7166	K003312	1)	172
SN7133	K011173	2)	176	SN7167	K002444	1)	172
SN7134	K001292	1)	170	SN7167	K006430	2)	174
SN7135	K001313	1)	170	SN7168	K002446	1)	172
SN7135	K015000	2)	178	SN7168	K006432	2)	174
SN7136	K001315	1)	170	SN7168	K011391		177
SN7136	K002576	1)	172	SN7169	K002522	1)	172
SN7136	K015002	2)	178	SN7169	K014655	2)	178
SN7136	K015004	2)	178	SN7169	K016813	2)	179

Products in Type Number order
Produkte, nach Typnummern geordnet

Classification des Produits par Type
Prodotti ordinati per Catalogo

Type Number	Part Number	Replacement/Remplacé par Ersatz / Sostituito da	Page	Type Number	Part Number	Replacement/Remplacé par Ersatz / Sostituito da	Page
SN7170	K002100	1)	171	SN7247	K005757	1)	174
SN7170	K010750	1)	176	SN7247	K005759	1)	174
SN7170	K011671	2)	177	SN7247	K014993	2)	178
SN7173	K002168	1)	171	SN7247	K014995	2)	178
SN7173	K013892		178	SN7248	K006605	2)	174
SN7174	K002247	1)	171	SN7249	K006872	1)	174
SN7174	K003665	1)	173	SN7249	K011672	1)	177
SN7174	K009282	1)	175	SN7250	K004550	1)	173
SN7175	K002223	1)	171	SN7250	K005038	1)	174
SN7176	K003313	1)	172	SN7250	K015010	2)	178
SN7177	K002445	1)	172	SN7252R	K004581	1)	173
SN7177	K006431	2)	174	SN7257	K005758	1)	174
SN7178	K002447	1)	172	SN7257	K005760	1)	174
SN7178	K006433	2)	174	SN7257	K014994	2)	178
SN7178	K011392		177	SN7257	K014996	2)	178
SN7179	K002523	1)	172	SN7258	K006606	2)	174
SN7179	K014656	2)	178	SN7259	K006873	1)	174
SN7179	K016814	2)	179	SN7259	K011673	1)	177
SN7183	K002517	1)	172	SN7260	K009258	1)	175
SN7183	K009277	1)	175	SN7260	K010114	1)	175
SN7193	K002518	1)	172	SN7260	K014344	1)	178
SN7193	K009278	1)	175	SN7260	K031432	1)	180
SN7202R	K003801	1)	173	SN7263	K009965	2)	175
SN7212R	K003802	1)	173	SN7263	K016811	2)	179
SN7227	K004496	1)	173	SN7264	K010155	1)	175
SN7228	K004545	1)	173	SN7264	K031428	1)	180
SN7228	K004804	1)	174	SN7264	K039468	2)	180
SN7228	K015005	2)	178	SN7266	K011130	2)	176
SN7228	K015007	2)	178	SN7266	K011132	1)	176
SN7229	K004547	1)	173	SN7267	K011294	2)	176
SN7229	K004854	1)	174	SN7268	K011296		176
SN7229	K005020	1)	174	SN7269	K011298	2)	176
SN7229	K015013	2)	178	SN7270	K009259	1)	175
SN7229	K015015	2)	178	SN7270	K010115	1)	175
SN7237	K004497	1)	173	SN7270	K014345	1)	178
SN7238	K004546	1)	173	SN7270	K031433	1)	180
SN7238	K004805	1)	174	SN7273	K009966	2)	175
SN7238	K015006	2)	178	SN7273	K016812	2)	179
SN7238	K015008	2)	178	SN7274	K010156	1)	175
SN7239	K004548	1)	173	SN7274	K031429	1)	180
SN7239	K004855	1)	174	SN7276	K011131	2)	176
SN7239	K005021	1)	174	SN7276	K011133	1)	176
SN7239	K015014	2)	178	SN7277	K011295	2)	176
SN7239	K015016	2)	178	SN7278	K011297		176
SN7240	K004549	1)	173	SN7279	K011299	2)	176
SN7240	K005037	1)	174	SN7280	K011300		176
SN7240	K015009	2)	178	SN7281	K011302	2)	176
SN7242R	K004580	1)	173	SN7282	K011304	2)	176

Products in Type Number order
Produkte, nach Typnummern geordnet

Classification des Produits par Type
Prodotti ordinati per Catalogo

Type Number	Part Number	Replacement/Remplacé par Ersatz / Sostituito da	Page	Type Number	Part Number	Replacement/Remplacé par Ersatz / Sostituito da	Page
SN7283	K011309		177	SN7377	K028144	²⁾	180
SN7283	K017395	²⁾	179	SN7400	K036798	²⁾	180
SN7284	K011700	²⁾	177	SN7405	K041454	²⁾	180
SN7285	K011702	²⁾	177	SN7410	K036799	²⁾	180
SN7287	K012009	²⁾	177	SN7415	K041455	²⁾	180
SN7288	K012343	²⁾	177	STK5382	II40329F		136
SN7290	K011301		176	SV1219	I41333	¹⁾ SV1481 (II36169)	198
SN7291	K011303	²⁾	176	SV1219	T41333	¹⁾ SV1481 (II36169)	198
SN7292	K011305	²⁾	176	SV1219	T47852	¹⁾ SV1481 (II36169)	198
SN7293	K011310		177	SV1289	I76269	¹⁾ SV1294 (K002335)	197
SN7293	K017396	²⁾	179	SV1290	I76270	¹⁾ SV1294 (K002335)	197
SN7294	K011701	²⁾	177	SV1291	I76271	¹⁾ SV1294 (K002335)	197
SN7295	K011703	²⁾	177	SV1292	I76272	¹⁾ SV1294 (K002335)	197
SN7297	K012010	²⁾	177	SV1294	I76274	¹⁾ SV1294 (K002335)	197
SN7298	K012344	²⁾	177	SV1294	I80091		197
SN7304	K013328	²⁾	177	SV1294	K002335		197
SN7307	K014522		178	SV1303	I78418	¹⁾ SV1303 (II32763)	197
SN7309	K016524	²⁾	179	SV1303	II32763		197
SN7309	K016526	¹⁾	179	SV1304	I79054	¹⁾ SV1304 (I85919)	197
SN7309	K016528	²⁾	179	SV1304	I85919		197
SN7314	K013329	²⁾	177	SV1307	K024765N00		197
SN7317	K014523		178	SV1318	II36108		197
SN7319	K016525	²⁾	179	SV1323	I84808	¹⁾ SV1323 (II32764)	197
SN7319	K016527	¹⁾	179	SV1323	II18503	¹⁾ SV1323 (II32764)	197
SN7319	K016529	²⁾	179	SV1323	II32764		197
SN7322R	K010743		176	SV1328	I86030	¹⁾ SV1328 (II32765)	197
SN7323	K015559	²⁾	179	SV1328	II32765		197
SN7324	K015557	¹⁾	179	SV1351	I88579	²⁾ SV1351 (K002334)	197
SN7329	K017195	²⁾	179	SV1351	K002334		197
SN7332R	K010744		176	SV1399	I94622	¹⁾ SV1399 (II30525000)	197
SN7333	K015560	²⁾	179	SV1399	II30525	²⁾ SV1399 (II30525000)	197
SN7334	K015558	¹⁾	179	SV1399	II30525000		197
SN7339	K017196	²⁾	179	SV1411	I98290		197
SN7340	K017477	²⁾	179	SV1412	I98292	²⁾ SV1412 (K000073)	197
SN7341	K017479		179	SV1412	K000073		197
SN7346	K019417	²⁾	179	SV1425	II16189		197
SN7347	K019759	²⁾	179	SV1443	II32789	²⁾ SV1466 (II36115)	197
SN7348	K019562	²⁾	179	SV1447	II34910		197
SN7350	K017478	²⁾	179	SV1460	K024764N00		197
SN7351	K017480		179	SV1463	II36099	¹⁾ SV1466 (II36115)	197
SN7356	K019418	²⁾	179	SV1463	II36100	¹⁾ SV1466 (II36115)	197
SN7357	K019760	²⁾	179	SV1463	II36142	²⁾ SV1466 (II36115)	197
SN7358	K019563	²⁾	179	SV1465	K000013	¹⁾ SV1485 (K000367)	198
SN7361	K023558		179	SV1466	II36115		197
SN7362	K023629	²⁾	179	SV1467	II36117		197
SN7367	K028143	²⁾	180	SV1468	II36118		197
SN7371	K023559		179	SV1468	K000069		197
SN7372	K023630	²⁾	179	SV1470	II36121		198

Products in Type Number order
Produkte, nach Typnummern geordnet

Classification des Produits par Type
Prodotti ordinati per Catalogo

Type Number	Part Number	Replacement/Remplacé par Ersatz / Sostituito da	Page	Type Number	Part Number	Replacement/Remplacé par Ersatz / Sostituito da	Page
SV1481	II36169		198	VPC3A	VPC3A	¹⁾ DR4258 (K000632)	38
SV1482	II36171		198	VPC3L	VPC3L	²⁾ DR4252 (K000626)	38
SV1483	II36212		198	VPS40AAY	VPS40AAY	²⁾ AE4644 (K019907)	41
SV1485	K000367		198	VPS40CY	VPS40CY	²⁾ AE4645 (K019908)	41
SV1490	K000264		198	VPS41AY	VPS41AY	²⁾ AE4641 (K019904)	41
SV1491	K000661		198	VPS41BY	VPS41BY	²⁾ AE4642 (K019905)	41
SV1493	K001245		198	VPS41CY	VPS41CY	²⁾ AE4643 (K019906)	41
SV1494	K001885	¹⁾ SV1494 (K002336)	198	VPS45A	VPS45A	²⁾ AE4646 (K019909)	41
SV1494	K002336		198	VPS45AY	VPS45AY	²⁾ AE4646 (K019909)	41
SV1496	K002398		198	VPS45C	VPS45C	²⁾ AE4648 (K019911)	41
SV3162	II36075		200	VSR2A	VSR2A	²⁾ KX2000/1	62
SV3203	II36184	²⁾ SV3240 (K002018)	108, 200	WE2130	I71205	¹⁾ WE2135 (I94846)	190
SV3230	II36151		200	WE2131	I71206		191
SV3240	K002018		108, 200	WE2135	I94846		190
SV3801	K022847N00		200	WE2137	II14936		190
SZ1115	I58893		223	WE2200	I34991	¹⁾ WE2207 (I92570)	190
SZ1130	I74963	¹⁾ SZ1161 (I90948)	223	WE2207	I92570		190
SZ1136	I76647		223	WHV-9	I30064		75
SZ1145	I83151		223	ZB3150	I78074		188
SZ1152	I87236		223	ZB3163	I92999		188
SZ1159	I85564		223	ZB3163	I929991		188
SZ1161	I90948		223	ZB3169	II41063F		188
SZ1166	I94326		223	ZB4275	K033367N50		17
SZ1190	II32920		223	ZB4289	II40284F	²⁾ ZB4289 (II40284F000)	17
T3700-D	K016153		160	ZB4289	II40284F000		17
T3700-I	K016152		160	ZB4400	K002241		23
T4300-D	131.777	²⁾	160	ZB4402	K004997		23
T4300-I	131.776	²⁾	160	ZB4403	K005280		23
VG3213	I92489		208	ZB4412	K007044		23
VG3221	I97142	²⁾ VG3286 (K002173)	209	ZB4414	K007498		23
VG3238	II19612		208	ZB4417	K009355		23
VG3264	II35696		208	ZB4418	K009521	²⁾ ZB4418 (K028205)	23
VG3265	II36373		209	ZB4418	K028205		23
VG3267	II36377		209	ZB4420	K009534	²⁾ ZB4420 (K028206)	23
VG3268	II37933		209	ZB4420	K028206		23
VG3269	II36379		209	ZB4422	K009740		23
VG3276	II40096F		209	ZB4424	K010593		23
VG3282	II40381F		209	ZB4427	K011823	²⁾ ZB4427 (K028207)	23
VG3283	K000411		209	ZB4427	K028207		23
VG3284	K000511		209	ZB4511	II35530	²⁾ ZB4721 (K025294N00)	24
VG3285	K001071		209	ZB4511	II35530170	²⁾ ZB4721 (K025294N00)	24
VG3286	K002173		209	ZB4512	II35531	²⁾ ZB4721 (K025294N00)	24
VG3287	K004295		209	ZB4512	II35531170	²⁾ ZB4721 (K025294N00)	24
VG3288	K004296		209	ZB4513	II36006	¹⁾ ZB4564 (II39866F)	23
VG3289	K004297		209	ZB4528	K010515		23
VG3364	II17771		209	ZB4534	II38310F	²⁾ ZB4534 (II38310FN00)	23
VG3365	II37940		209	ZB4534	II38310FN00		23
VG8125	I87819		209	ZB4535	II38311F	²⁾ ZB4534 (II38310FN00)	23

Products in Type Number order
Produkte, nach Typnummern geordnet

Classification des Produits par Type
Prodotti ordinati per Catalogo

Type Number	Part Number	Replacement/Remplacé par Ersatz / Sostituito da	Page	Type Number	Part Number	Replacement/Remplacé par Ersatz / Sostituito da	Page
ZB4544	II38619F	²⁾ ZB4544 (II38619FN00)	23	ZB4700	K011986N00		24
ZB4544	II38619F000	²⁾ ZB4544 (II38619FN00)	23	ZB4701	K011987	²⁾ ZB4701 (K011987N00)	24
ZB4544	II38619FN00		23	ZB4701	K011987N00		24
ZB4545	II38005F	¹⁾ ZB4578 (K000394N00)	23	ZB4706	K014682	²⁾ ZB4706 (K014682N00)	24
ZB4564	II39866F		23	ZB4706	K014682N00		24
ZB4578	K000394	²⁾ ZB4578 (K000394N00)	23	ZB4707	K014683	²⁾ ZB4707 (K014683N00)	24
ZB4578	K000394N00		23	ZB4707	K014683N00		24
ZB4579	K000395	²⁾ ZB4579 (K000395N00)	23	ZB4708	K014684	²⁾ ZB4708 (K014684N00)	24
ZB4579	K000395N00		23	ZB4708	K014684N00		24
ZB4580	K000396	²⁾ ZB4580 (K000396N00)	23	ZB4709	K014695	²⁾ ZB4706 (K014682N00)	24
ZB4580	K000396N00		23	ZB4710	K014696	²⁾ ZB4707 (K014683N00)	24
ZB4586	K012242	²⁾ ZB4586 (K012242N00)	23	ZB4721	K025294N00		24
ZB4586	K012242N00		23	ZB4723	K031708N03	²⁾	24
ZB4587	K012243	²⁾ ZB4587 (K012243N00)	23	ZB4724	K033949N00		24
ZB4587	K012243N00		23	ZB4800	K002432	²⁾ ZB4809 (K025295N00)	24
ZB4588	K012244N00		24	ZB4801	K002734	²⁾ ZB4809 (K025295N00)	24
ZB4589	K001449	²⁾ ZB4589 (K001449N00)	24	ZB4802	K002735	²⁾ ZB4809 (K025295N00)	24
ZB4589	K001449N00		24	ZB4803	K002736	²⁾ ZB4809 (K025295N00)	24
ZB4590	K001450	²⁾ ZB4590 (K001450N00)	24	ZB4803	K002736N00		24
ZB4590	K001450N00		24	ZB4809	K025295	²⁾ ZB4809 (K025295N00)	24
ZB4591	K001453	²⁾ ZB4591 (K001453N00)	24	ZB4809	K025295N00		24
ZB4591	K001453N00		24	ZB9032	II37951004EX	²⁾ II37951004EN	232
ZB4592	K012245	²⁾ ZB4592 (K012245N00)	24	ZE4501	K012576	²⁾	24
ZB4592	K012245N00		24	ZE4600	II41221F	²⁾	24
ZB4593	K012246	²⁾ ZB4593 (K012246N00)	24	ZE4601	K011481	²⁾	24
ZB4593	K012246N00		24				
ZB4594	K012247N00		24				
ZB4595	K001457	²⁾ ZB4595 (K001457N00)	24				
ZB4595	K001457N00		24				
ZB4596	K001458	²⁾ ZB4596 (K001458N00)	24				
ZB4596	K001458N00		24				
ZB4597	K001459	²⁾ ZB4597 (K001459N00)	24				
ZB4597	K001459N00		24				
ZB4600	K001982	²⁾ ZB4600 (K001982N00)	24				
ZB4600	K001982N00		24				
ZB4601	K001983	²⁾ ZB4601 (K001983N00)	24				
ZB4601	K001983N00		24				
ZB4602	K001984	²⁾ ZB4602 (K001984N00)	24				
ZB4602	K001984N00		24				
ZB4603	K001985	²⁾ ZB4603 (K001985N00)	24				
ZB4603	K001985N00		24				
ZB4606	K002149N00		24				
ZB4607	K006066N00		24				
ZB4608	K013763N00		24				
ZB4609	K013764N00		24				
ZB4610	K013765N00		24				
ZB4611	K013766	²⁾	24				
ZB4700	K011986	²⁾ ZB4700 (K011986N00)	24				

Commercial Vehicle Systems

Head Office

**Knorr-Bremse Systeme für
Nutzfahrzeuge GmbH**

Moosacher Strasse 80
80809 Munich
Germany
Tel: +49 89 3547-0
Fax: +49 89 3547-2767
www.knorr-bremseCVS.com

Europe – Africa

Austria
**Knorr-Bremse GmbH
Systeme für Nutzfahrzeuge**
Mödling
Tel: +43 2236 409-2436
Fax: +43 2236 409-2434

Belgium
Knorr-Bremse Benelux B.V.B.A.
Heist-op-den-Berg
Tel: +32 1525 7900
Fax: +32 1524 9240

Czech Republic
**Knorr-Bremse Systémy pro
užitkovú vozidla, CR, s.r.o.**
Liberec
Tel: +420 482 363-611
Fax: +420 482 363-711

France
**Knorr-Bremse
Systèmes pour Véhicules
Utilitaires France**
Lisieux Cedex
Tel: +33 2 3132 1200
Fax: +33 2 3132 1303

Germany
Hasse & Wrede GmbH
Berlin
Tel: +49 30 9392-3101
Fax: +49 30 7009-0811

Germany
**Knorr-Bremse Systeme für
Nutzfahrzeuge GmbH**
Berlin
Tel: +49 180 223-7637
Fax: +49 30 9392-3426

Hungary
**Knorr-Bremse
Fékrendszerek Kft.**
Kecskemét
Tel: +36 76 511 100
Fax: +36 76 481 100

Italy
**Knorr-Bremse
Sistemi per Autoveicoli
Commerciali S.p.A.**
Arcore
Tel: +39 039 6075-1
Fax: +39 039 6075-435

Netherlands
Knorr-Bremse Benelux B.V.B.A.
Mydrecht
Tel: +31 297 239-330
Fax: +31 297 239-339

Poland
Knorr-Bremse Polska SfN Sp. z o.o.
Warsaw
Tel: +48 22 887-3870
Fax: +48 22 531-4170

Russia
Knorr-Bremse RUS
Nizhniy Novgorod
Tel: +7 8312 57-6661
Fax: +7 8312 57-6791

Russia
**Knorr-Bremse
Systeme für Nutzfahrzeuge GmbH**
Moscow
Tel: +7 495 234-4995
Fax: +7 495 234-4996

South Africa
Knorr-Bremse S.A. Pty. Ltd.
Kempton Park
Tel: +27 11 961-7800
Fax: +27 11 975-8249

Spain
Bost Ibérica, S.L.
Irun (Guipuzcoa)
Tel: +34 902 100-569
Fax: +34 943 614-063

Sweden
**Knorr-Bremse
System for Tunga Fordon AB**
Lund
Tel: +46 46 440 0105
Fax: +46 46 148971

Switzerland
**Knorr-Bremse
Systeme für Nutzfahrzeuge GmbH**
Bassersdorf
Tel: +41 44 888 77-55
Fax: +41 44 888 77-50

Turkey
**Knorr-Bremse
Ticari Araç Fren Sistemleri Tic. Ltd. Sti.**
Findikli - Istanbul
Tel: +90 212 293-4742
Fax: +90 212 293-4743

United Kingdom
**Knorr-Bremse
Systems for Commercial Vehicles Ltd.**
Bristol
Tel: +44 117 9846-100
Fax: +44 117 9846-101

America

Brazil
**Knorr-Bremse
Sistemas para Veículos
Comerciais Brasil Ltda.**
São Paulo
Tel: +55 11 5681 1104
Fax: +55 11 5686 3905

USA
**Bendix Commercial Vehicle
Systems LLC**
Elyria, OH
Tel: +1 440 329-9100
Fax: +1 440 329-9105

Asia – Australia

Australia
**Knorr-Bremse
Australia Pty. Ltd.**
Granville NSW
Tel: +61 2 8863-6500
Fax: +61 2 8863-6510

China
**Knorr-Bremse
Brake Equipment (Shanghai) Co. Ltd.**
Shanghai
Tel: +86 21 3858-5800
Fax: +86 21 3858-5900

China
**Knorr-Bremse
Asia Pacific (Holding) Limited
Commercial Vehicle Systems Division**
Hong Kong
Tel: +852 3657-9800
Fax: +852 3657-9901

India
**Knorr-Bremse
Systems for Commercial Vehicles
India Private Ltd.**
Pune
Tel: +91 20 6674-6800
Fax: +91 20 6674-6899

Japan
**Knorr-Bremse
Commercial Vehicle Systems
Japan Ltd.**
Saitama
Tel: +81 49 273-9155
Fax: +81 49 282-8601

Korea
**Knorr-Bremse
Korea Ltd. Truck Brake Division**
Seoul
Tel: +82 2 2273-1182
Fax: +82 2 2273-1184

This document is subject to alteration without notice and therefore a printed copy may not be the latest revision. Please check our website www.knorr-bremseCVS.com for the latest update or contact your local Knorr-Bremse representative. The figurative mark "K" and the trademarks KNORR and KNORR-BREMSE are registered in the name of Knorr-Bremse AG. Additional terms and conditions apply, please refer to our website knorr-bremseCVS.com under the "Documentation" tab.
Note: If service work is carried out on a vehicle as a result of information taken from this document, it is the responsibility of the workshop to ensure the vehicle is fully tested and in full functional order before the vehicle is returned into service. Knorr-Bremse accepts no liability for problems caused as a result of inappropriate tests not being carried out.
Copyright 2010 © Knorr-Bremse AG – all rights reserved, including industrial property rights applications. Knorr-Bremse AG retains any power of disposal, such as for copying and transferring. Released 11/2010



Knorr-Bremse Group

Doc. No. Y030321-EN-DE-FR-IT-006
Item No. K055509